

Rotating PCB Support Kit for Access DH Probers – Part number 98-0579

The Rotating PCB Support Kit allows for a more flexible method to support odd shaped and difficult to mount PCBs within the Access DH Prober. The kit consists of various spacers and arms that combine to form a standoff that is used to support a PCB from the edges or from PCB mounting holes. Below are the included pieces and their part numbers.

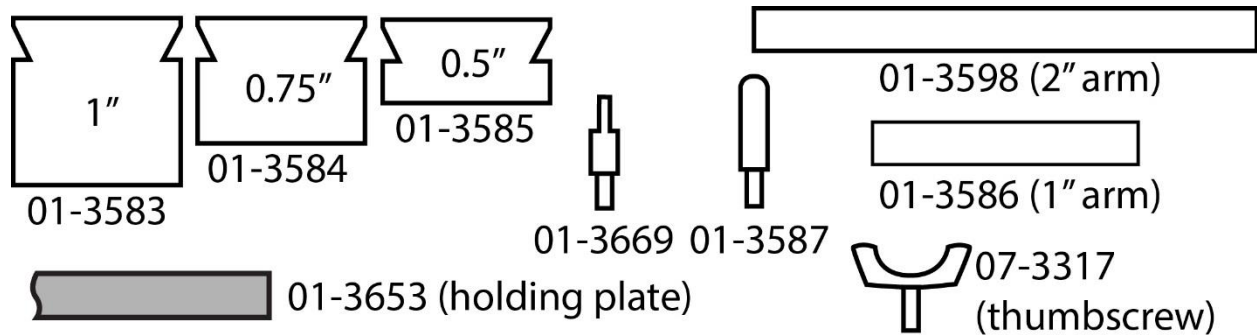

The kits pieces can be used to create a “Post Stack” which serves as an anchor support from the board edge, an adjustable “Rotating Stack” that supports the PCB from the board edge, a “Support Stack” which supports the PCB from underneath and a “Plate Stack” which uses a secondary holding plate. Use the diagrams shown on the following pages of this document to create stacks used with the Top, Middle, Bottom and Base slots of the Access DH Prober.

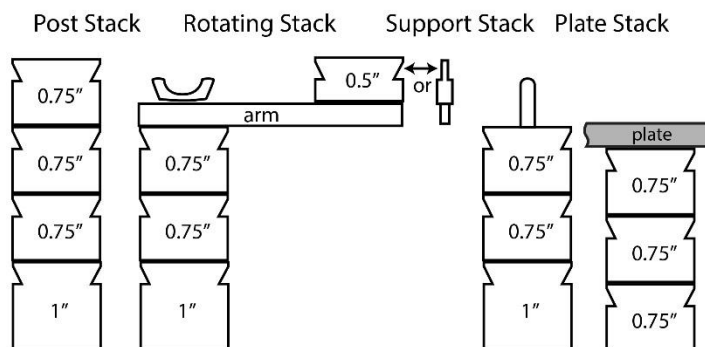
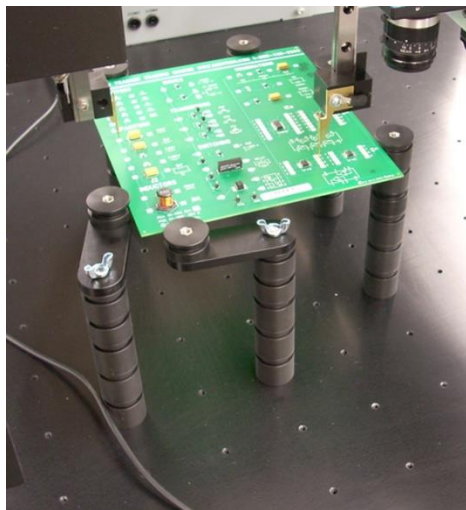

The Universal Fixture plate that makes up the support bed for the Access DH Prober has threaded mounting holes spaced at 2 inch intervals for attaching the Post, Rotating, Support and Plate stacks.

An additional holding plate (part number 01-3653) is included in the kit to simplify the mounting of PCBs

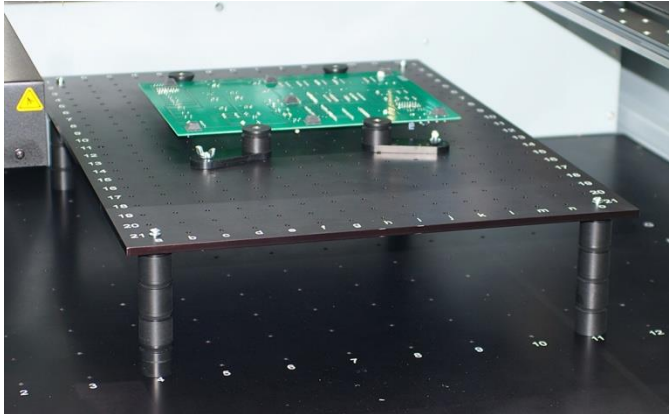

at a higher level. The plate is mounted on four Post Stacks and then additional spacers are added on top of the holding plate to secure the PCB in place. This method adds an additional degree of rigidity to the mounted board. The holding plate is 0.25" thick so the spacer sizes need to be adjusted to make up for the added height. The diagrams on the following pages showing the spacer Stack combinations include drawings using the additional holding plate (Plate Stack).

The holding plate is best mounted to the Access DH base plate at screw holes B4, B11, L4 and L11 (shown in image above). For additional support, stacks can be added at G4 and G11. The mounting holes on the holding plate are enlarged to make mounting easier. Use the screws provided (part number 07-3347) to mount the holding plate to the spacer stacks. Below is one suggested configuration for using the holding plate in the Middle slot position.

PCB Mounting Examples using Middle Slot level

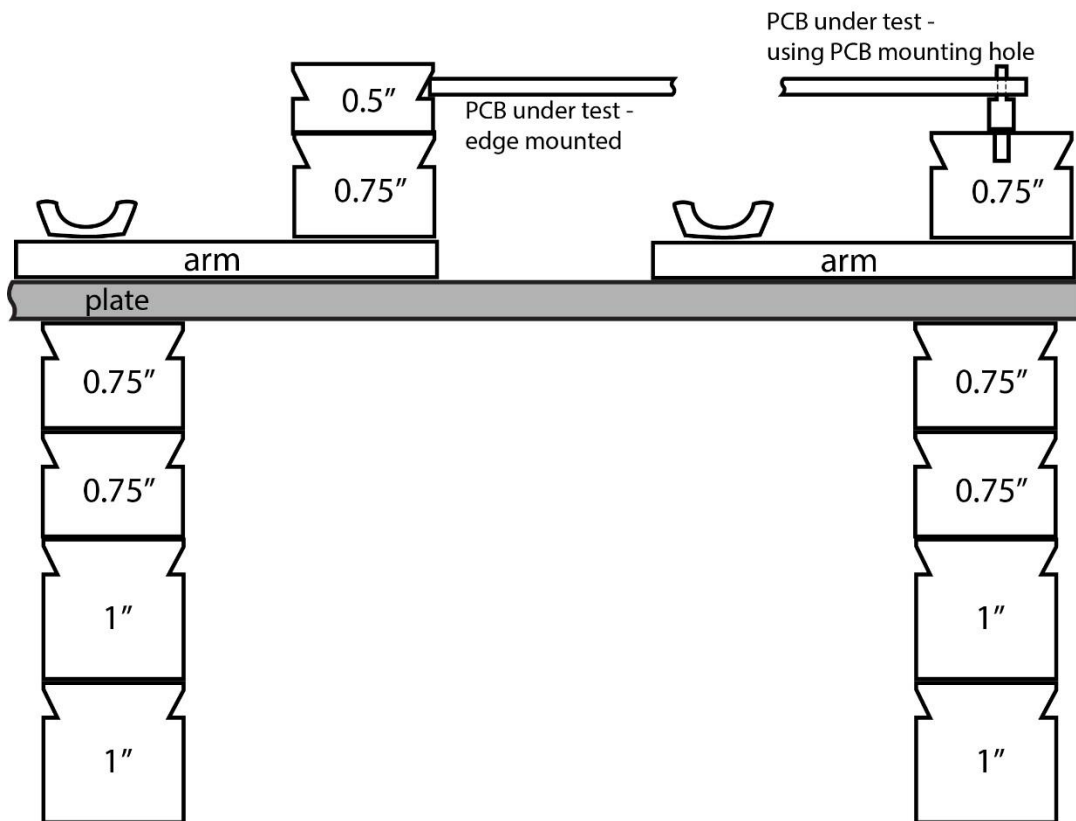

Top Slot Support Combinations

Post Stack Rotating Stack Support Stack Plate Stack

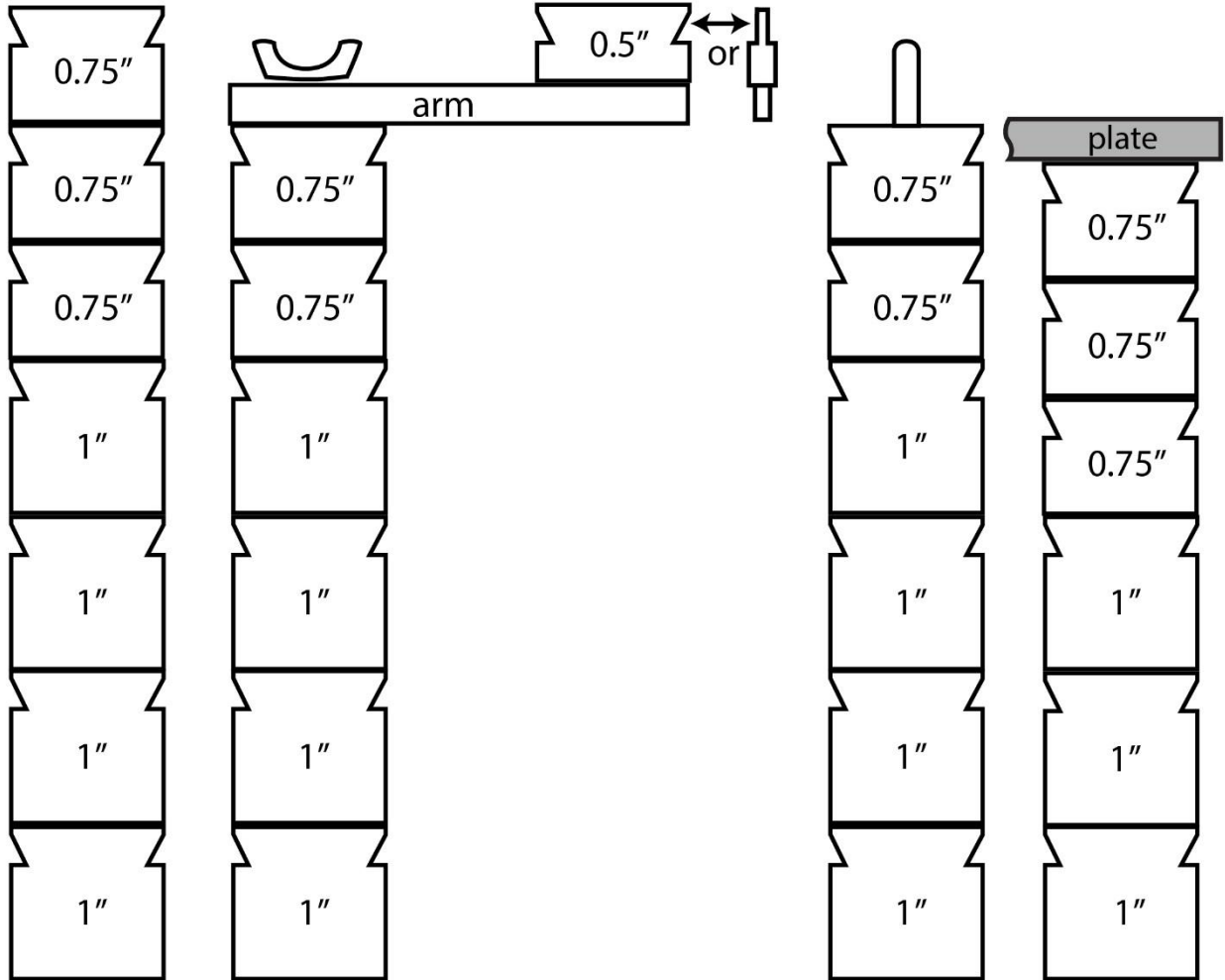

Middle Slot Support Combinations

Post Stack Rotating Stack Support Stack Plate Stack

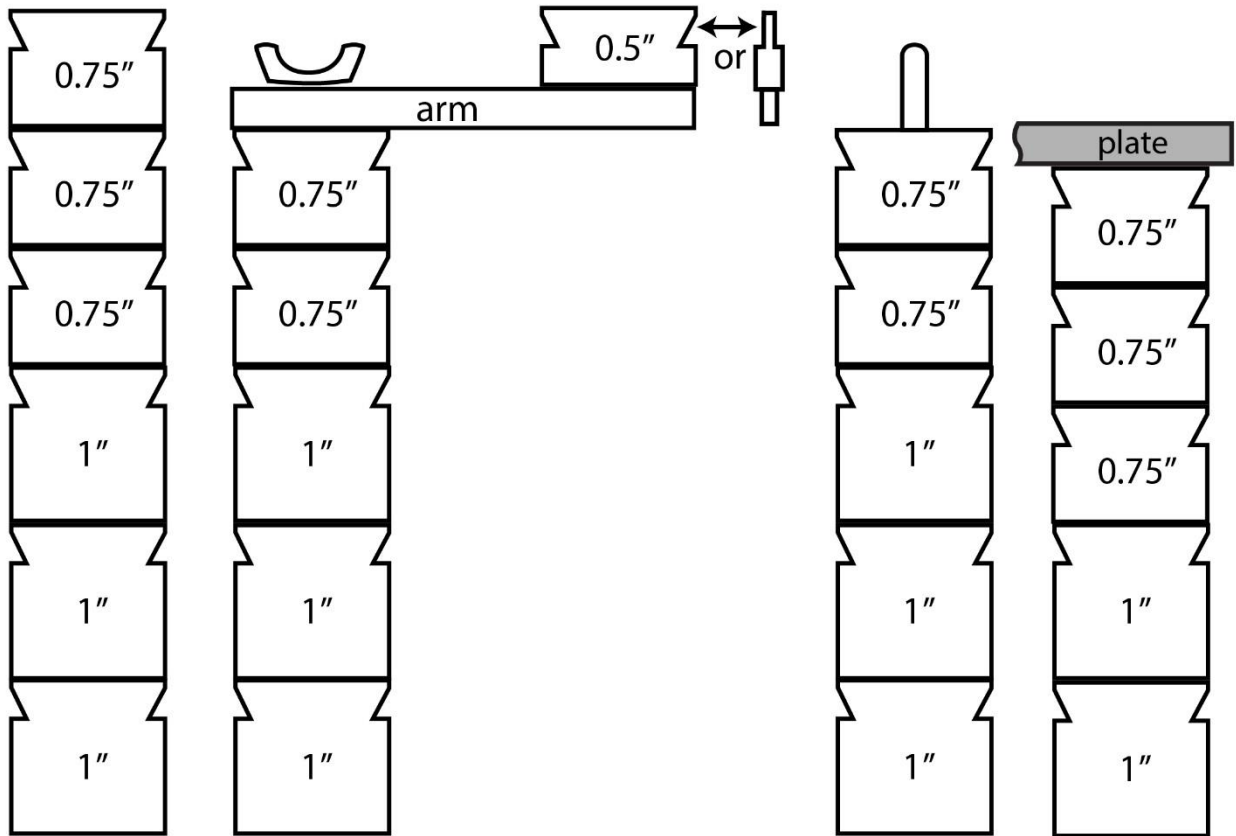

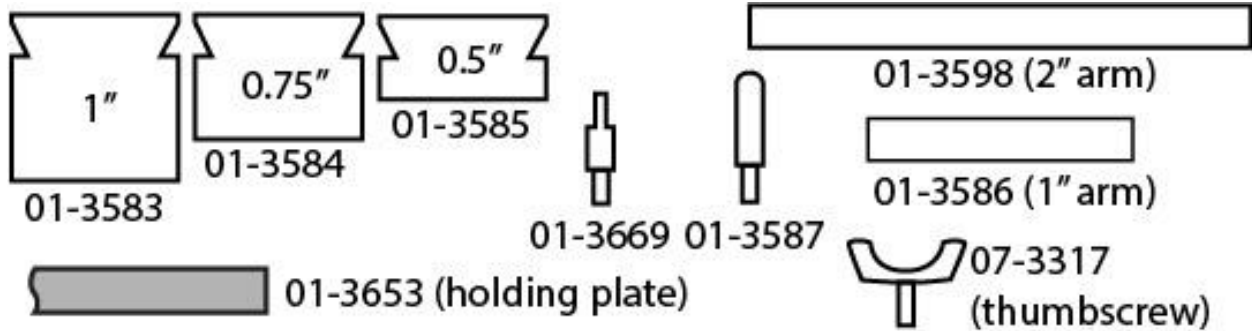

Bottom Slot Support Combinations

Post Stack Rotating Stack Support Stack Plate Stack

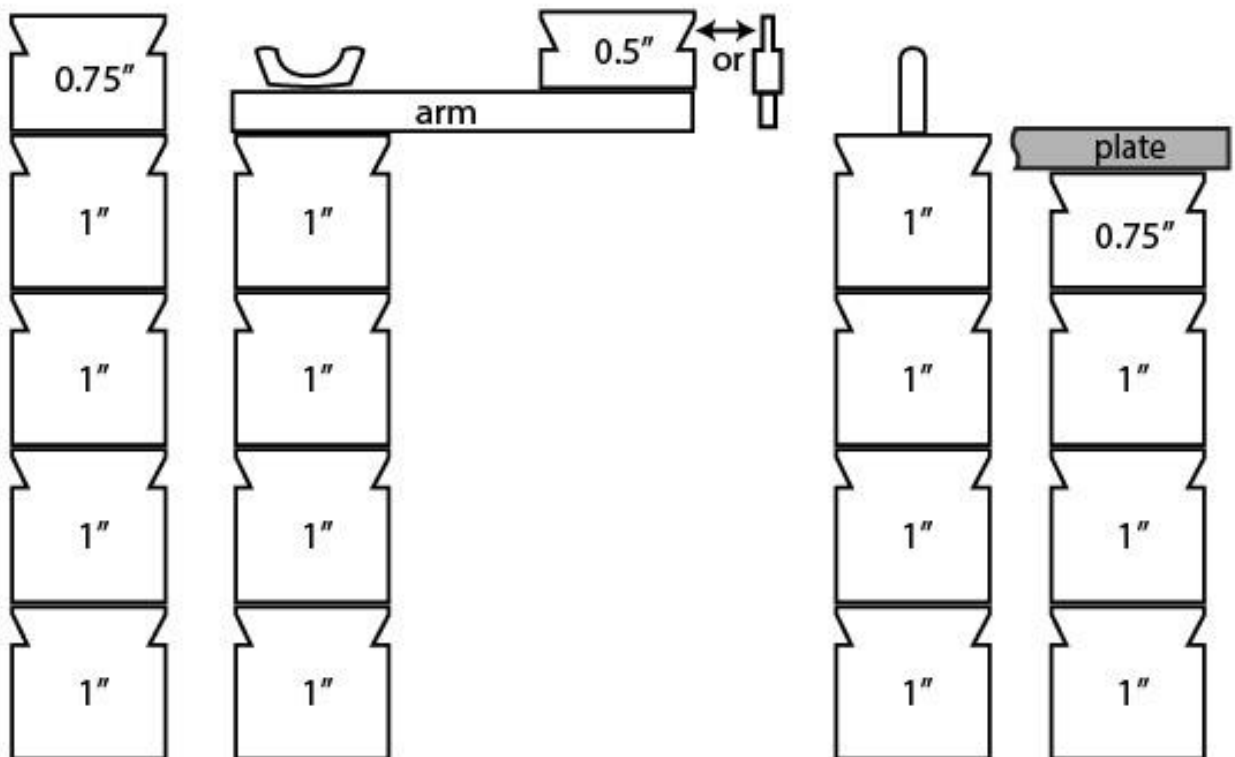

Base Slot Support Combinations

Post Stack

Rotating Stack

Support Stack

Plate Stack

