

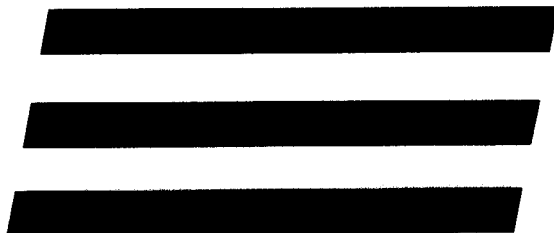

# **Tracker 2000**

Operation and  
Maintenance Manual

**HUNTRON<sup>®</sup>**



# HUNTRON® TRACKER®

## LIMITED WARRANTY

For a period of one year from the date of its purchase new and undamaged from Huntron Instruments, Inc. HUNTRON INSTRUMENTS, INC. will without charge, repair or replace, at its option, this product if found by it to be defective in materials or workmanship. Products purchased in the United States are to be returned to Huntron Instruments, Inc. at its factory, transportation prepaid. Products purchased outside the United States are to be returned to the source of purchase. This limited warranty is expressly conditioned upon the product having been used only in normal usage and serviced in accordance with instruction of HUNTRON INSTRUMENTS, INC. and not having been altered in any way or subject to misuse, negligence or damage, and not having been repaired or attempted to be repaired by anyone other than HUNTRON INSTRUMENTS, INC. or its authorized agents. **EXCEPT FOR THE FOREGOING EXPRESS WARRANTY OF REPAIR OR REPLACEMENT, HUNTRON INSTRUMENTS, INC. MAKES NO WARRANTY OF ANY KIND, INCLUDING BUT NOT LIMITED TO, ANY EXPRESS OR IMPLIED WARRANTY OF MERCHANTABILITY OR FITNESS FOR ANY PARTICULAR PURPOSE, AND HUNTRON INSTRUMENTS, INC. SHALL NOT BE LIABLE FOR ANY DAMAGES, WHETHER DIRECT OR INDIRECT, CONSEQUENTIAL OR INCIDENTAL, FORESEEABLE OR NOT, OR OTHERWISE, BEYOND REPAIRING OR REPLACING THIS PRODUCT. THIS WARRANTY IS NOT APPLICABLE TO EXTERNAL CABLES, CLIPS, WIRING OR POWER SUPPLY.**

## CHANGE INFORMATION

ISSUE NO: 7 6/93

P/N 21-1207

This change contains information necessary to ensure the accuracy of the following manual:

Title: **HUNTRON TRACKER 2000 OPERATING  
AND MAINTENANCE MANUAL**

Print Date: **August 1985**

Revision: **6**

Revision Date: **11/90**

### CHANGE #7

On Page 5-7:

CHANGE: 1.A1.R46

FROM: Res CF, 220K $\Omega$ , 5%, 1/2W      02-2204    09021    CF 1/2 220K J

TO: Res CF, 360K $\Omega$ , 5%, 1/4W      02-2349    09021    CF 1/4 360K J

On Page 6-4, Figure 6-2, in the "SELECTED RESISTORS" table:

CHANGE: R46, Toshiba

FROM: 220K

TO: 360K

### CHANGE #8

On Page 5-11:

CHANGE: 1.A2.R33

FROM: Res CF, 10K $\Omega$ , 5%, 1/4W      02-2137    09021    CF 1/4 10K J

TO: Res MF, 8.25K $\Omega$ , 1%, 1/4W      02-2351    09021    MF55D8251F

CHANGE: 1.A2.R34

FROM: Res CF, 100K $\Omega$ , 5%, 1/4W      02-2139    09021    CF 1/4 100K J

TO: Res MF, 90.9K $\Omega$ , 0.1%, 1/4W      02-2319    09021    MF55E9092B

CHANGE: 1.A2.R35

FROM: Res VAR, 100K $\Omega$ , 25%      02-1026    51406    RVS0707V-100-3-104

TO: Res VAR, 20K $\Omega$ , 25%      02-1032    51406    RVS0707V-100-3-203

On Page 6-7, Figure 6-4:

CHANGE: R33

FROM: 10K

TO: 8.25K 1%

CHANGE: R34

FROM: 100K

TO: 90.9K .1%

CHANGE: R35

FROM: 100K

TO: 20K

## CHANGE #9

On Page 5-5:

CHANGE:	1.A1.C35			
FROM:	Cap, Electrolytic 2.2 $\mu$ F, 50V	03-3046	00199	CEUSM1H2R2
TO:	Cap, Tant 4.7 $\mu$ F, 50V	03-3088	31433	T350G475M050AS

On Page 5-8:

CHANGE:	1.A1.U2			
FROM:	IC, Hex Schmitt Trigger Inverter	05-5018	27014	74C14
TO:	IC, Hex Schmitt Trigger Inverter	05-5062	27014	74HC14

On Page 5-9:

CHANGE:	1.A1.U18			
FROM:	IC, Hex Schmitt Trigger Inverter	05-5018	27014	74C14
TO:	IC, Hex Schmitt Trigger Inverter	05-5062	27014	74HC14

On Page 6-4, Figure 6-2:

CHANGE:	U2 (between Q2 and U3)			
FROM:	74C14			
TO:	74HC14			

On Page 6-5, Figure 6-2:

CHANGE:	C35			
FROM:	2.2 $\mu$ F			
TO:	4.7 $\mu$ F			

CHANGE:	U18 (next to C35)			
FROM:	74C14			
TO:	74HC14			

CHANGE:	U2 (at NEGATIVE input)			
FROM:	74C14			
TO:	74HC14			



# **HUNTRON TRACKER 2000**

## **OPERATION AND MAINTENANCE MANUAL**

**August 1985**

**P/N 21-1052**

**Rev. 6, 11/90**

Huntron<sup>®</sup> and Tracker<sup>®</sup> are registered trademarks of Huntron Instruments, Inc.

Copyright© 1985, Huntron Instruments, Inc. All rights reserved.

Covered by U.S. patents 3,973,198 and 4,074,195, and various other foreign patents.

This document may not be copied in whole or in part, or otherwise reproduced except as specifically permitted under U.S. copyright law, without the prior written consent of Huntron Instruments, Inc., 15720 Mill Creek Blvd., Mill Creek, WA 98012.

## **ABOUT THIS MANUAL**

This instruction manual is divided into two major parts. Sections 1 through 6 cover the general operation and maintenance of your instrument. Sections 7 through 15 cover applications and specific uses for your Tracker test instrument.

## **CONTACTING HUNTRON**

For technical support or to obtain information about service, accessories, and other products, contact Huntron Instruments, Inc., 15720 Mill Creek Blvd., Mill Creek, WA 98012. In the United States, call (toll-free) 800-426-9265. Huntron is also accessible by fax at 206-743-1360 or telex at 152951. Outside the United States, call your local distributor for assistance or service.

# TABLE OF CONTENTS

## Section 1 INTRODUCTION AND SPECIFICATIONS

---

1-1.	INTRODUCTION .....	1-1
1-2.	SPECIFICATIONS .....	1-2
1-3.	SAFETY CONSIDERATIONS .....	1-4
1-4.	LIST OF ACCESSORIES .....	1-4

## Section 2 OPERATING INSTRUCTIONS

---

2-1.	INTRODUCTION .....	2-1
2-2.	UNPACKING YOUR INSTRUMENT .....	2-1
2-3.	GENERAL OPERATION .....	2-1
2-4.	FUSE REPLACEMENT .....	2-2
2-5.	PHYSICAL FEATURES .....	2-2
2-6.	Front Panel .....	2-2
2-7.	Back Panel .....	2-4
2-8.	CRT Display .....	2-4
2-9.	OPERATION .....	2-5
2-10.	INITIAL SETUP .....	2-6
2-11.	Range Selection .....	2-6
2-12.	Channel Selection .....	2-6
2-13.	Frequency Selection .....	2-8
2-14.	Pulse Generator .....	2-8
2-15.	HUNTRON SWITCHER 410 CONNECTIONS .....	2-10
2-16.	TRACKER TRAINING .....	2-11
2-17.	EXTERNAL CLEANING AND LUBRICATION .....	2-11
2-18.	STORAGE INSTRUCTIONS .....	2-11

## Section 3 THEORY OF OPERATION

---

3-1.	INTRODUCTION .....	3-1
3-2.	FUNCTIONAL OVERVIEW .....	3-1
3-3.	Control Logic .....	3-2
3-4.	Oscillator .....	3-3
3-5.	Signal Section .....	3-4
3-6.	Pulse Generator .....	3-5
3-7.	CRT Display .....	3-7
3-8.	Power Supply .....	3-7
3-9.	VOLTAGE AND POWER CONSIDERATIONS .....	3-7
3-10.	Power in a Resistor .....	3-8
3-11.	Power in a Diode .....	3-9
3-12.	Power in a Zener Diode .....	3-10

# TABLE OF CONTENTS (con't)

## Section 4 MAINTENANCE

---

4-1.	INTRODUCTION .....	4-1
4-2.	SERVICE INFORMATION .....	4-1
4-3.	CMOS HANDLING PROCEDURES .....	4-1
4-4.	DISASSEMBLY PROCEDURE .....	4-2
4-5.	REASSEMBLY PROCEDURE .....	4-9
4-6.	PERFORMANCE TESTS .....	4-11
4-7.	INTERNAL ADJUSTMENTS .....	4-14
4-8.	TROUBLESHOOTING .....	4-18

## Section 5 LIST OF REPLACEABLE PARTS

---

5-1.	INTRODUCTION .....	5-1
5-2.	HOW TO OBTAIN PARTS .....	5-1

## Section 6 SCHEMATIC DIAGRAMS

---

6-1.	SCHEMATICS .....	6-1
------	------------------	-----

## Section 7 RESISTORS, CAPACITORS AND INDUCTORS

---

7-1.	TESTING RESISTORS .....	7-1
7-2.	Low Range .....	7-1
7-3.	Medium 1 Range .....	7-1
7-4.	Medium 2 Range .....	7-2
7-5.	High Range .....	7-3
7-6.	TESTING CAPACITORS .....	7-3
7-7.	TESTING INDUCTORS .....	7-5
7-8.	TESTING FERRITE INDUCTORS .....	7-7

## Section 8 TESTING DIODES

---

8-1.	THE SEMICONDUCTOR DIODE AND ITS CHARACTERISTICS .....	8-1
8-2.	Diode Symbol and Definition .....	8-1
8-3.	The Volt-Ampere Characteristic .....	8-2
8-4.	SILICON DIODES .....	8-2
8-5.	Signatures of a Good Diode .....	8-2
8-6.	Signatures of Defective Diodes .....	8-3
8-7.	Signatures of a High Voltage Diode .....	8-7
8-8.	RECTIFIER BRIDGES .....	8-8
8-9.	LIGHT EMITTING DIODES .....	8-10
8-10.	ZENER DIODES .....	8-10

# TABLE OF CONTENTS (con't)

## Section 9 TESTING TRANSISTORS

---

9-1.	BIPOLAR JUNCTION TRANSISTORS .....	9-1
9-2.	An Important Note About Testing Transistors .....	9-2
9-3.	NPN BIPOLAR TRANSISTORS .....	9-2
9-4.	B-E Junction .....	9-3
9-5.	C-B Junction .....	9-3
9-6.	C-E Connection .....	9-3
9-7.	PNP BIPOLAR TRANSISTORS .....	9-5
9-8.	B-E Junction .....	9-5
9-9.	C-B Junction .....	9-6
9-10.	C-E Connection .....	9-7
9-11.	POWER TRANSISTORS - NPN AND PNP .....	9-8
9-12.	DARLINGTON TRANSISTORS .....	9-8
9-13.	Comparing B-E Junctions .....	9-9
9-14.	Comparing C-E Connections .....	9-11
9-15.	Comparing C-B Junctions .....	9-13
9-16.	JUNCTION FIELD EFFECT TRANSISTORS .....	9-13
9-17.	Gate-Source Connection .....	9-14
9-18.	Drain-Gate Connection .....	9-15
9-19.	Drain-Source Connection .....	9-16
9-20.	MOS FIELD EFFECT TRANSISTORS .....	9-16
9-21.	MOSFET WITH PROTECTION DIODE .....	9-17
9-22.	Gate-Source Connection .....	9-18
9-23.	Drain-Gate Connection .....	9-19
9-24.	Drain-Source Connection .....	9-20
9-25.	MOSFET WITHOUT A PROTECTION DIODE .....	9-21

## Section 10 USING THE PULSE GENERATOR

---

10-1.	INTRODUCTION .....	10-1
10-2.	SILICON CONTROLLED RECTIFIERS (SCR) .....	10-1
10-3.	TRIAC DEVICES .....	10-5
10-4.	TRANSISTORS .....	10-7
10-5.	OPTOCOUPERS .....	10-10
10-6.	Transistor Optocoupler .....	10-11
10-7.	Darlington Transistor Optocoupler .....	10-15
10-8.	SCR Optocoupler .....	10-19
10-9.	Triac Optocoupler .....	10-23
10-10.	Photocell Optocoupler .....	10-26

# TABLE OF CONTENTS (con't)

## Section 11 TESTING MULTIPLE COMPONENT CIRCUITS

---

11-1.	2000 DIAGNOSTIC PRINCIPLES .....	11-1
11-2.	DIODE/RESISTOR CIRCUITS .....	11-1
11-3.	Diode In Parallel With A Resistor .....	11-1
11-4.	Diode In Series With A Resistor .....	11-4
11-5.	DIODE AND CAPACITOR PARALLEL COMBINATION .....	11-6
11-6.	RESISTOR AND CAPACITOR PARALLEL COMBINATION .....	11-10
11-7.	INDUCTOR AND DIODE PARALLEL COMBINATION .....	11-11

## Section 12 TESTING INTEGRATED CIRCUITS

---

12-1.	INTRODUCTION .....	12-1
12-2.	Integrated Circuit Technology .....	12-1
12-3.	Integrated Circuit Testing Techniques .....	12-2
12-4.	LINEAR OPERATIONAL AMPLIFIERS .....	12-3
12-5.	LINEAR VOLTAGE REGULATORS .....	12-8
12-6.	The 7805 Regulator .....	12-8
12-7.	The 7905 Regulator .....	12-11
12-8.	555 TIMERS .....	12-14
12-9.	TTL DIGITAL INTEGRATED CIRCUITS .....	12-20
12-10.	General .....	12-20
12-11.	TTL Devices With Totem Pole Output .....	12-21
12-12.	LS TTL Devices .....	12-24
12-13.	Tri-State LS TTL Devices .....	12-25
12-14.	CMOS INTEGRATED CIRCUITS .....	12-28
12-15.	Quad NAND Gate .....	12-29
12-16.	Analog Switch .....	12-30
12-17.	MOS STATIC RAM .....	12-33
12-18.	EPROM .....	12-36
12-19.	BIPOLAR PROM .....	12-40
12-20.	DIGITAL TO ANALOG CONVERTER .....	12-43
12-21.	MICROPROCESSORS .....	12-47

## Section 13 TESTING COMPONENTS BY COMPARISON

---

13-1.	INTRODUCTION .....	13-1
13-2.	SETUP PROCEDURES .....	13-1
13-3.	POWER TRANSISTORS MJE240 .....	13-2
13-4.	MJE240 B-E Junction .....	13-2
13-5.	MJE240 C-E Connection .....	13-4
13-6.	HIGH VOLTAGE DIODE HV15F .....	13-6
13-7.	100 $\mu$ F 25V ELECTROLYTIC CAPACITOR .....	13-7

# TABLE OF CONTENTS (con't)

## Section 14 SOLVING BUS PROBLEMS

---

14-1.	INTRODUCTION .....	14-1
14-2.	STUCK WIRED-OR BUS .....	14-1
14-3.	UNSTUCK WIRED-OR BUS .....	14-1
14-4.	MEMORIES .....	14-1

## Section 15 TROUBLESHOOTING TIPS

---

15-1.	TIPS ON USING YOUR 2000 .....	15-1
-------	-------------------------------	------

## Appendices

---

Appendix A	HUNTRON TRACKER CMOS TEST .....	A-1
Appendix B	HUNTRON TRACKER TTL AND CMOS TESTS .....	B-1

# LIST OF ILLUSTRATIONS

Figure	Description	Page
1-1	Huntron Tracker 2000 .....	1-1
2-1	Front Panel .....	2-2
2-2	Back Panel .....	2-4
2-3	CRT Display .....	2-5
2-4	Alternate Mode Setup .....	2-7
2-5	Auto/Alternate Sequence .....	2-7
2-6	Pulse Generator Comparison Mode .....	2-8
2-7	Pulse Generator Selector Chart .....	2-9
2-8	2000/Switcher Interconnection .....	2-10
3-1	2000 Block Diagram .....	3-1
3-2	Range Scanning Sequence with AUTO and ALT Active .....	3-3
3-3	Signal Section Equivalent Circuit .....	3-4
3-4a	Open Circuit Display All Ranges .....	3-5
3-4b	Short Circuit Display All Ranges .....	3-5
3-5	Pulse Generator/Signal Section Equivalent Circuit .....	3-5
3-6	Pulse Generator Waveforms .....	3-6
3-7	Resistor Test Circuit .....	3-8
3-8a	Diode Test Circuit .....	3-9
3-8b	Diode Current Waveform .....	3-9
3-9a	Zener Diode Test Circuit .....	3-10
3-9b	Zener Diode Signature .....	3-10
4-1	Case Screws Removal .....	4-2
4-2	CRT Assembly Removal .....	4-3
4-3	Signal PCB Assembly Removal .....	4-4
4-4	Power Transformer Removal .....	4-5
4-5	Main PCB Assembly Removal .....	4-6
4-6	Front Control Assembly Removal .....	4-7
4-7	Control PCB Assembly Removal .....	4-8
4-8	Main PCB Adjustment Locations .....	4-14
4-9	Signal PCB Adjustment Locations .....	4-15
4-10	Signal PCB Waveforms: TP1 & TP4 .....	4-22
4-11	Signal PCB Waveforms: TP1 & TP5 (400 Hz) .....	4-22
4-12	Signal PCB Waveforms: TP1 & TP5 (2000 Hz) .....	4-23
4-13	Signal PCB Waveforms: TP1 & TP6 (50/60 Hz) .....	4-23
4-14	Signal PCB Waveforms: TP1 & TP6 (400 Hz) .....	4-24
4-15	Signal PCB Waveforms: TP1 & TP6 (2000 Hz) .....	4-24
4-16	Signal PCB Waveforms: TP1 & TP9 (50/60 Hz) .....	4-25
4-17	Signal PCB Waveforms: TP1 & TP9 (400 Hz) .....	4-25
4-18	Signal PCB Waveforms: TP1 & TP9 (2000 Hz) .....	4-26
4-19	Signal PCB Waveforms: TP1 & TP10 (50/60 Hz) .....	4-26
4-20	Signal PCB Waveforms: TP1 & TP11 (open) .....	4-27



# LIST OF ILLUSTRATIONS (con't)

Figure	Description	Page
4-21	Signal PCB Waveforms: TP1 & TP11 (short) .....	4-27
4-22	Signal PCB Waveforms: TP1 & TP12 (open) .....	4-28
4-23	Signal PCB Waveforms: TP1 & TP12 (short) .....	4-28
5-1	Final Assembly .....	5-2
5-2	Front Control Assembly .....	5-3
5-3	CRT Assembly .....	5-3
6-1	Main PCB Component Locations .....	6-2
6-2	Main PCB Schematic .....	6-4
6-3	Signal PCB Component Locations .....	6-6
6-4	Signal PCB Schematic .....	6-7
6-5	Control PCB Component Locations .....	6-8
6-6	Control PCB Schematic .....	6-9
7-1	Effects of Resistance on the Rotation Angle - Low Range .....	7-1
7-2	Effects of Resistance on the Rotation Angle - Medium 1 Range .....	7-2
7-3	Effects of Resistance on the Rotation Angle - Medium 2 Range .....	7-2
7-4	Effects of Resistance on the Rotation Angle - High Range .....	7-3
7-5	Signatures of a 0.22 $\mu$ F Capacitor .....	7-4
7-6	Signatures of a 250 mH Inductor .....	7-6
7-7	Signatures of a 490 mH Ferrite Inductor Tested at 60 Hz .....	7-7
7-8	Signatures of a 490 mH Ferrite Inductor Tested at 400 Hz .....	7-8
7-9	Signatures of a 490 mH Ferrite Inductor Tested at 2000 Hz .....	7-8
8-1	Diode Symbol .....	8-1
8-2	P-N Junction Biased in the Forward Direction .....	8-1
8-3	P-N Junction Biased in the Reverse Direction .....	8-1
8-4	The Volt-Ampere Characteristic of a Semiconductor Diode .....	8-2
8-5	Signatures of a Silicon Diode at 60 Hz .....	8-3
8-6	Signature of an Open Diode .....	8-4
8-7	Effect of Resistance on the Signature in Low Range at 60 Hz .....	8-4
8-8a	Signature Deviation from a Good Diode in Low Range at 60 Hz .....	8-4
8-8b	Signature Deviation from a Good Diode in Medium 1 Range at 60 Hz .....	8-5
8-9a	Model of Diode with Leakage Resistance of R .....	8-5
8-9b	Influence of Leakage Resistance in Low Range at 60 Hz .....	8-5
8-9c	Influence of Leakage Resistance in Medium 1 Range at 60 Hz .....	8-6
8-9d	Influence of Leakage Resistance in Medium 2 Range at 60 Hz .....	8-6
8-9e	Influence of Leakage Resistance in High Range at 60 Hz .....	8-6
8-10a	Signatures of a 1N4001 and an HV30 in Low Range at 60 Hz .....	8-7
8-10b	Signatures of a 1N4001 and an HV30 in Low Range at 2000 Hz .....	8-7
8-11	Rectifier Bridge Test Connection-AC Input .....	8-8
8-12	Signature of a Good Rectifier Bridge (All Ranges at 60 Hz) .....	8-8
8-13	Signature with D2 or D4 Shorted in Low Range at 60 Hz .....	8-9
8-14	Signature with D1 or D3 Shorted in Low Range at 60 Hz .....	8-9
8-15	Rectifier Bridge Connections-DC Output .....	8-9

# LIST OF ILLUSTRATIONS (con't)

Figure	Description	Page
8-16	Signature of the DC Output in Low Range at 60 Hz .....	8-9
8-17	Rectifier Bridge Reversed Test Connections .....	8-9
8-18	Signature with the DC Output Reversed in Low Range at 60 Hz .....	8-9
8-19	LED Signatures .....	8-10
8-20	Characteristics of a Typical 30V Zener Diode .....	8-10
8-21	Signatures of a 1N5242 Zener Diode at 60 Hz .....	8-11
8-22	Signature of a good Zener Diode in Medium 1 Range at 60 Hz .....	8-12
8-23	Signature of an inferior Zener Diode in Medium 1 Range at 60 Hz .....	8-12
8-24	Signatures of a PN2222 B-E Junction at 60Hz .....	8-12
8-25	Signatures of a PN2222 B-E Junction in High Range at 2000 Hz .....	8-13
9-1	PNP Transistor and Circuit Symbol .....	9-1
9-2	NPN Transistor and Circuit Symbol .....	9-1
9-3	Equivalent Circuit of an NPN Transistor .....	9-2
9-4	Signatures of an NPN Transistor (2N3904) at 60 Hz Base with Emitter as Common ...	9-3
9-5	Signatures of an NPN Transistor (2N3904) at 60 Hz Collector with Base as Common ...	9-4
9-6	Signatures of an NPN Transistor (2N3904) at 60 Hz Collector with Emitter as Common	9-4
9-7	Equivalent Circuit of a PNP Transistor .....	9-5
9-8	Signatures of a PNP Transistor (2N3906) at 60 Hz Base with Emitter as Common ...	9-5
9-9	Signatures of a PNP Transistor (2N3906) at 60 Hz Collector with Base as Common ...	9-6
9-10	Signatures of a PNP Transistor (2N3906) at 60 Hz Collector with Emitter as Common	9-7
9-11	Signatures of an NPN Power Transistor (TIP50) at 60 Hz and 2000 Hz Base with Emitter as Common .....	9-8
9-12	Darlington Transistor-Schematic Diagrams .....	9-8
9-13	The TIP112 Darlington Transistor .....	9-8
9-14	Base-Emitter Test Circuit .....	9-9
9-15	Signature Comparison of a Darlington Transistor (TIP112) and a Regular Transistor (TIP29) at 60 Hz Base with Emitter as Common .....	9-10
9-16	Collector-Emitter Test Circuit .....	9-11
9-17	Signature Comparison of a Darlington Transistor (TIP112) and a Regular Transistor (TIP29) at 60 Hz Collector with Emitter as Common .....	9-12
9-18	Circuit Symbol for an N-Channel JFET .....	9-13
9-19	Basic Structure of an N-Channel JFET .....	9-13
9-20	Signatures of an N-Channel JFET (2N5638) at 60 Hz Gate with Source as Common ..	9-14
9-21	Signatures of an N-Channel JFET (2N5638) at 60 Hz Drain with Gate as Common ...	9-15
9-22	Signatures of an N-Channel JFET (2N5638) at 60 Hz Drain with Source as Common ..	9-16
9-23	N-Channel and P-Channel MOSFET Devices .....	9-17
9-24	VN10KM MOSFET with a Gate-Source Protection Diode .....	9-17
9-25	Signatures of an N-Channel Enhancement Mode MOSFET (VN10KM) at 60 Hz Gate with Source as Common .....	9-18
9-26	Signatures of an Enhancement Mode MOSFET (VN10KM) at 60 Hz Drain with Gate as Common .....	9-19
9-27	Signatures of an Enhancement Mode MOSFET (VN10KM) at 60 Hz Drain with Source as Common. Gate Open Circuit .....	9-20
9-28	VN10LM MOSFET without a Gate-Source Protection Diode .....	9-21
10-1	Silicon Controlled Rectifier .....	10-1
10-2	Signatures of a C103 SCR at 60 Hz. Gate with Cathode as Common .....	10-2
10-3	SCR Test Circuit using Pulse Generator .....	10-2

# LIST OF ILLUSTRATIONS (con't)

Figure	Description	Page
10-4	Zero Level All Ranges at 60 Hz .....	10-3
10-5	Effect of the Level Control (Width=Max) at 60 Hz .....	10-3
10-7	Low Range at 60 Hz .....	10-4
10-8	The Construction and Symbol of a Triac .....	10-5
10-9	Gate-MT1 Equivalent Circuit .....	10-5
10-10	Signatures of a 2N6070 Triac at 60 Hz Gate with MT1 as Common .....	10-6
10-11	Triac Test Circuit Using Pulse Generator .....	10-6
10-12	MT1-MT2 Signatures of a 2N6070 Triac with Gate Connected to Pulse Generator at 60 Hz .....	10-7
10-13a	NPN Transistor Test Circuit Using Pulse Generator .....	10-8
10-13b	Medium 1 Range at 60 Hz .....	10-8
10-14a	Effect of the Level Control on the NPN Test (Width=Max) Medium 1 Range at 60 Hz .....	10-9
10-14b	Effect of the Width Control at Constant Level on NPN test, Medium 1 Range at 60 Hz .....	10-9
10-15a	PNP Transistor Test Circuit Using the Pulse Generator .....	10-9
10-15b	Medium 1 Range at 60 Hz .....	10-10
10-15c	Effect of Level Control (Width=Max) Medium 1 Range at 60 Hz .....	10-10
10-15d	Effect of the Width Control at a Constant Level Medium 1 Range at 60 Hz .....	10-10
10-16	Pin Configuration of a 4N25 Transistor Optocoupler .....	10-11
10-17	Signatures of the LED of a 4N25 at 60 Hz Pin 1 with Pin 2 as Common .....	10-11
10-18	Signatures of the Base-Emitter of a 4N25 at 60 Hz Pin 6 with Pin 4 as Common .....	10-12
10-19	Signatures of the Collector-Emitter of a 4N25 at 60 Hz Pin 5 with Pin 4 as Common ..	10-12
10-20	Optocoupler Test Connections Using Pulse Generator .....	10-13
10-21a	Effect of the Level Control (Width=Max) Medium 1 Range at 60 Hz .....	10-14
10-21b	Effect of the Width Control at a Constant Level Medium 1 Range at 60 Hz .....	10-14
10-22	Pulse Generator Comparison Mode .....	10-14
10-23	Pin Configuration of a 4N31 Darlington Transistor Optocoupler .....	10-15
10-24	Signatures of the LED of a 4N31 at 60 Hz Pin 1 with Pin 2 as Common .....	10-15
10-25	Signatures of the Base-Emitter of a 4N31 at 60 Hz Pin 6 with Pin 4 as Common .....	10-16
10-26	Signatures of the Collector-Emitter of a 4N31 at 60 Hz Pin 5 with Pin 4 as Common ..	10-16
10-27	Test Circuit for a 4N31 with Pulse Generator .....	10-17
10-28	Signature Variations of a 4N31 as a Function of Pulse Level (Maximum Pulse Width) at 60 Hz .....	10-18
10-29	Pin Configuration of an H11C3 SCR Optocoupler .....	10-19
10-30	Signatures of the LED of an H11C3 at 60 Hz Pin 1 with Pin 2 as Common .....	10-19
10-31	Signatures Between Anode and Cathode of an H11C3 at 60 Hz Pin 5 with Pin 4 as Common .....	10-20
10-32	Signatures Between Cathode and Gate of an H11C3 at 60 Hz Pin 5 with Pin 6 as Common .....	10-20
10-33	Test Circuit for an H11C3 with Pulse Generator .....	10-21
10-34	Signature Variations of a H11C3 as a Function of Pulse Level for the Maximum Pulse Width at 60 Hz .....	10-22
10-35	Pin Configuration of a MOC3010 Triac Optocoupler .....	10-23
10-36	Signatures of the LED part of a MOC3010 at 60 Hz Pin 1 with Pin 2 as Common .....	10-23
10-37	Signatures of the Triac of a MOC3010 at 60 Hz Pin 6 with Pin 5 as Common .....	10-24
10-38	Test Circuit for a MOC3010 Triac with Pulse Generator .....	10-24

# LIST OF ILLUSTRATIONS (con't)

Figure	Description	Page
10-39	Signature Variations of a MOC3010 as a Function of the Pulse Level (Maximum Pulse Width) at 60 Hz .....	10-25
10-40	Pin Configuration of a CLM51 Photocell Optocoupler .....	10-26
10-41	Signatures of the LED of a CLM51 at 60 Hz Pin 1 with Pin 2 as Common .....	10-26
10-42	Signatures of the Cell of a CLM51 at 60 Hz Pin 6 with Pin 5 as Common .....	10-27
10-43	Test Circuit for a CLM51 with Pulse Generator .....	10-27
10-44	Signature Variations of a CLM51 as a Function of the Pulse Level (Maximum Pulse Width) at 60 Hz .....	10-28
11-1	Parallel Diode/Resistor Signatures-Low Range .....	11-2
11-2	Parallel Diode/Resistor Signatures-Medium 1 Range .....	11-3
11-3	Diode/Resistor Equivalent Circuits .....	11-4
11-4	Low Range Signatures for Various Resistors and Series Diode at 60 Hz .....	11-4
11-5	Medium 1 Range Signatures for Various Resistors and Series Diode at 60 Hz .....	11-5
11-6	Medium 2 Range Signatures for Various Resistors and Series Diode at 60 Hz .....	11-5
11-7	High Range Signatures for Various Resistors and Series Diode at 60 Hz .....	11-5
11-8	Signatures of 0.1 $\mu$ F Capacitor in Parallel with 1N4001 Diode Tested at 60 Hz and 2000 Hz .....	11-7
11-9	Signatures of 1 $\mu$ F Capacitor in Parallel with 1N4001 Diode Tested at 60 Hz and 2000 Hz .....	11-8
11-10	Signatures of 100 $\mu$ F Capacitor in Parallel with 1N4001 Diode Tested at 60 Hz and 2000 Hz .....	11-9
11-11	Effects of a 50K $\Omega$ Resistor on a 0.1 $\mu$ F Capacitor in the High Range at 60 Hz .....	11-10
11-12	Effects of a 1K $\Omega$ Resistor on a 1 $\mu$ F Capacitor in the Medium 1 Range at 60 Hz .....	11-10
11-13	Signatures of a 1N4001 Diode in Parallel with an Aromat Relay HB1E-DC12 .....	11-11
12-1	Typical Integrated Circuit Construction .....	12-1
12-2	The LM1458 Op Amp, Schematic and Connections .....	12-4
12-3	Signatures Between Pin 4 (V-) and Pin 8 (V+) of an LM1458 at 60 Hz .....	12-4
12-4	Signatures Between Pin 2 (Inverting Input) and Pin 8 (V+) of an LM1458 at 60 Hz ...	12-5
12-5	Signatures Between Pin 3 (Non-Inverting Input) and Pin 8 (V+) of an LM1458 at 60 Hz .....	12-5
12-6	Signatures Between Pin 1 (Output) and Pin 8(V+) of an LM1458 at 60 Hz .....	12-6
12-7	Signatures Between Pin 2 (Inverting Input) and Pin 4 (V-) of an LM1458 at 60 Hz ...	12-6
12-8	Signatures Between Pin 3 (Non-Inverting Input) and Pin 4 (V-) of an LM1458 at 60 Hz	12-7
12-9	Signatures Between Pin 1 (Output) and Pin 4 (V-) of an LM1458 at 60 Hz .....	12-7
12-10	Signatures Between Pin 8 (V+) and Pin 4 (V-) of a Defective LM1458 at 60 Hz .....	12-8
12-11	Schematic and Pin Layout of the 7805 .....	12-9
12-12	Signatures Between the Input and Ground Pins - 7805 at 60 Hz .....	12-9
12-13	Signatures Between the Output and Ground Pins - 7805 at 60 Hz .....	12-10
12-14	Signatures Between the Input and Output Pins - 7805 at 60 Hz .....	12-10
12-15	Signatures Between the Input and Output Pins of a Defective 7805 at 60 Hz .....	12-11
12-16	Schematic and Pin Layout of the 7905 .....	12-12
12-17	Signatures Between the Input and Ground Pins - 7905 at 60 Hz .....	12-12
12-18	Signatures Between the Output and Ground Pins - 7905 at 60 Hz .....	12-13
12-19	Signatures Between the Input and Output Pins - 7905 at 60 Hz .....	12-13
12-20	Signatures Between the Input and Output Pins of a Defective 7905 at 60 Hz .....	12-14

# LIST OF ILLUSTRATIONS (con't)

Figure	Description	Page
12-21	Schematic and Pin Layout of an LM555 Timer	12-15
12-22	Signatures Between Pin 2 (Trigger) and Pin 1 of an LM555 Timer at 60 Hz	12-16
12-23	Signatures Between Pin 3 (Output) and Pin 1 of an LM555 Timer at 60 Hz	12-16
12-24	Signatures Between Pin 4 (Reset) and Pin 1 of an LM555 Timer at 60 Hz	12-17
12-25	Signatures Between Pin 5 (Control Voltage) and Pin 1 of an LM555 Timer at 60 Hz	12-17
12-26	Test Circuit of an LM555 Pin 5 and Pin 1	12-18
12-27	Signatures Between Pin 6 (Threshold) and Pin 1 of an LM555 Timer at 60 Hz	12-18
12-28	Signatures Between Pin 7 (Discharge) and Pin 1 of an LM555 Timer at 60 Hz	12-19
12-29	Signatures Between Pin 8 ( $V_{cc}$ ) and Pin 1 of an LM555 Timer at 60 Hz	12-19
12-30	Signatures Between Pin 8 ( $V_{cc}$ ) and Pin 1 of a Damaged LM555 Timer at 60 Hz	12-20
12-31	Various TTL Implementations	12-21
12-32	Signatures Between an Input Pin and the Ground Pin of a 7410 at 60 Hz	12-22
12-33	Signatures Between an Output Pin and the Ground Pin of a 7410 at 60 Hz	12-23
12-34	Signatures Between the $V_{cc}$ Pin and the Ground Pin of a 7410 at 60 Hz	12-23
12-35	Signatures Between an Input Pin and the Ground Pin of a 7410 at 60 Hz	12-24
12-36	Signatures Between an Input Pin and Output Pin of a 74LS32 at 60 Hz	12-24
12-37	Signatures Between the $V_{cc}$ Pin and Ground Pin of a 74LS32 at 60 Hz	12-25
12-38	Typical Tri-State Output Control	12-26
12-39	Pin Layout of a 74LS125	12-26
12-40	Signatures Between an Input Pin and the Ground Pin of a 74LS125 at 60 Hz	12-27
12-41	Signatures Between the Enable Pin and the Ground Pin of a 74LS125 at 60 Hz	12-27
12-42	Signatures Between the $V_{cc}$ Pin and the Ground Pin of a 74LS125 at 60 Hz	12-28
12-43	Schematic and Pin Layout of a 4011B	12-29
12-44	Signatures Between an Input Pin and $V_{SS}$ - $V_{DD}$ of a 4011B at 60 Hz	12-29
12-45	Signatures Between an Output Pin and $V_{SS}$ - $V_{DD}$ of a 4011B at 60 Hz	12-30
12-46	Schematic and Pin Layout of a 4016B	12-30
12-47	Signatures Between an Input Pin and $V_{SS}$ - $V_{DD}$ of a 4016B at 60 Hz	12-31
12-48	Signatures Between an Output Pin and $V_{SS}$ - $V_{DD}$ of a 4016B at 60 Hz	12-31
12-49	Signatures Between a Control Pin and $V_{SS}$ - $V_{DD}$ of a 4016B at 60 Hz	12-32
12-50	Signatures Between an Input Pin and $V_{SS}$ - $V_{DD}$ of a Defective 4016B at 60 Hz	12-32
12-51	Pin Layout of a 2114A Static RAM	12-33
12-52	Signatures Between an Address Pin and the Ground Pin of a 2114A Static RAM at 60 Hz	12-33
12-53	Signatures Between the CS Pin and the Ground Pin of a 2114A Static RAM at 60 Hz	12-34
12-54	Signatures Between the WE Pin and the Ground Pin of a 2114A static RAM at 60 Hz	12-34
12-55	Signatures Between an I/O Pin and the Ground Pin of a 2114A Static RAM at 60 Hz	12-35
12-56	Signatures Between the $V_{cc}$ Pin and the Ground Pin of a 2114A Static RAM at 60 Hz	12-35
12-57	Pin Layout of a 2708JL	12-36
12-58	Signatures Between an Address Pin and the $V_{SS}$ Pin of a 2708JL at 60 Hz	12-37
12-59	Signatures Between an Output Pin and the $V_{SS}$ Pin of a 2708JL at 60 Hz	12-37
12-60	Signatures Between the Program Pin and the $V_{SS}$ Pin of a 2708JL at 60 Hz	12-38
12-61	Signatures Between the $V_{DD}$ Pin and the $V_{SS}$ Pin of a 2708JL at 60 Hz	12-38
12-62	Signatures Between the CS Pin and the $V_{SS}$ Pin of a 2708JL at 60 Hz	12-39

# LIST OF ILLUSTRATIONS (con't)

Figure	Description	Page
12-63	Signatures Between the $V_{bb}$ Pin and the $V_{ss}$ Pin of a 2708JL at 60 Hz	12-39
12-64	Signatures Between the $V_{cc}$ Pin and the $V_{ss}$ Pin of a 2708JL at 60 Hz	12-40
12-65	Pin Layout of a 6301-1J	12-40
12-66	Signatures Between an Address Pin and the Ground Pin of a 6301-1J at 60 Hz	12-41
12-67	Signatures Between an Output Pin and the Ground Pin of a 6301-1J at 60 Hz	12-41
12-68	Signatures Between the E2 Pin and the Ground Pin of a 6301-1J at 60 Hz	12-42
12-69	Signatures Between the $V_{cc}$ Pin and the Ground Pin of a 6301-1J at 60 Hz	12-42
12-70	Pin Layout and the Equivalent Circuit of a DAC0800L	12-43
12-71	Signatures Between the $V_{LC}$ Pin and the $V^-$ Pin of a DAC0800L at 60 Hz	12-43
12-72	Signatures Between the $I_{out}$ Pin and the $V^-$ Pin of a DAC0800L at 60 Hz	12-44
12-73	Signatures Between a Digital Input Pin and the $V^-$ Pin of a DAC0800L at 60 Hz	12-44
12-74	Signatures Between the $V_{ref(+)}$ Pin and the $V^-$ Pin of a DAC0800L at 60 Hz	12-45
12-75	Signatures Between the $V_{ref(-)}$ Pin and the $V^-$ Pin of a DAC0800L at 60 Hz	12-45
12-76	Signatures Between the Compensation Pin and the $V^-$ Pin of a DAC0800L at 60 Hz	12-46
12-77	Signatures Between the $V^+$ and $V^-$ Pins of a DAC0800L at 60 Hz	12-46
12-78	Pin Layout of an 8080A	12-47
12-79	Signatures Between an Address Pin and the $-5V$ Pin of an 8080A at 60 Hz	12-47
12-80	Signatures Between a Data Pin and the $-5V$ Pin of an 8080A at 60 Hz	12-48
12-81	Signatures Between the Reset Pin and the $-5V$ Pin of an 8080A at 60 Hz	12-48
12-82	Signatures Between the $+5V$ Pin and the $-5V$ Pin of an 8080A at 60 Hz	12-49
12-83	Signatures Between the $+12V$ Pin and the $-5V$ Pin of an 8080A at 60 Hz	12-49
12-84	Signatures Between the INTE Pin and the $-5V$ Pin of an 8080A at 60 Hz	12-50
13-1	Alternate Mode Setup	13-2
13-2	Signatures Between Base-Emitter of a Good MJE240 Transistor	13-3
13-3	Signatures Between Base-Emitter of a Defective MJE240 Transistor	13-3
13-4	Signatures Between Collector-Emitter of a Good MJE240 Transistor	13-4
13-5	Signatures Between Collector-Emitter of a Defective MJE240 Transistor	13-5
13-6	Signatures of a Good HV15F Diode	13-6
13-7	Signatures of a Defective HV15F Diode	13-6
13-8	Signatures of a Known Good Capacitor	13-7
13-9	Signatures of a Defective Capacitor	13-7

# LIST OF TABLES

Table	Description	Page
1-1	Tracker 2000 Specifications .....	1-2
2-1	Front Panel Controls & Connectors .....	2-3
2-2	Back Panel Controls & Connectors .....	2-4
2-3	Horizontal Sensitivities .....	2-5
3-1	Terminal Characteristics .....	3-4
4-1	Power Supply Limits .....	4-19
4-2	Power Supply Troubleshooting Guide .....	4-19
4-3	Performance Test Troubleshooting Guide .....	4-20
4-4	Additional Troubleshooting Guide .....	4-21
6-1	DC Resistance of Coils and Transformer .....	6-10
6-2	Pulse Generator Terminal Wiring Harness .....	6-11
6-3	Test Terminal Wiring Harness .....	6-11
6-4	CRT Assembly Wiring Harness .....	6-12
6-5	Power Transformer Assembly Wiring Harness .....	6-13
7-1	Min/Max Capacitance Values .....	7-5
11-1	Diagnostic Table .....	11-1

# SECTION 1

## INTRODUCTION AND SPECIFICATIONS

### 1-1. INTRODUCTION

The Huntron Tracker 2000, shown in Figure 1-1, is a versatile troubleshooting tool having the following features:

- Multiple test signal frequencies (50/60 Hz, 400 Hz, 2000 Hz).
- Four impedance ranges (low, medium 1, medium 2, high).
- Automatic range scanning.
- Range control: High Lockout.
- Rate of channel alternation and/or range scanning is adjustable.
- Dual polarity pulse generator for dynamic testing of three terminal devices.
- LED indicators for all functions.
- Dual channel capability for easy comparison.
- Large CRT display with easy to operate controls.

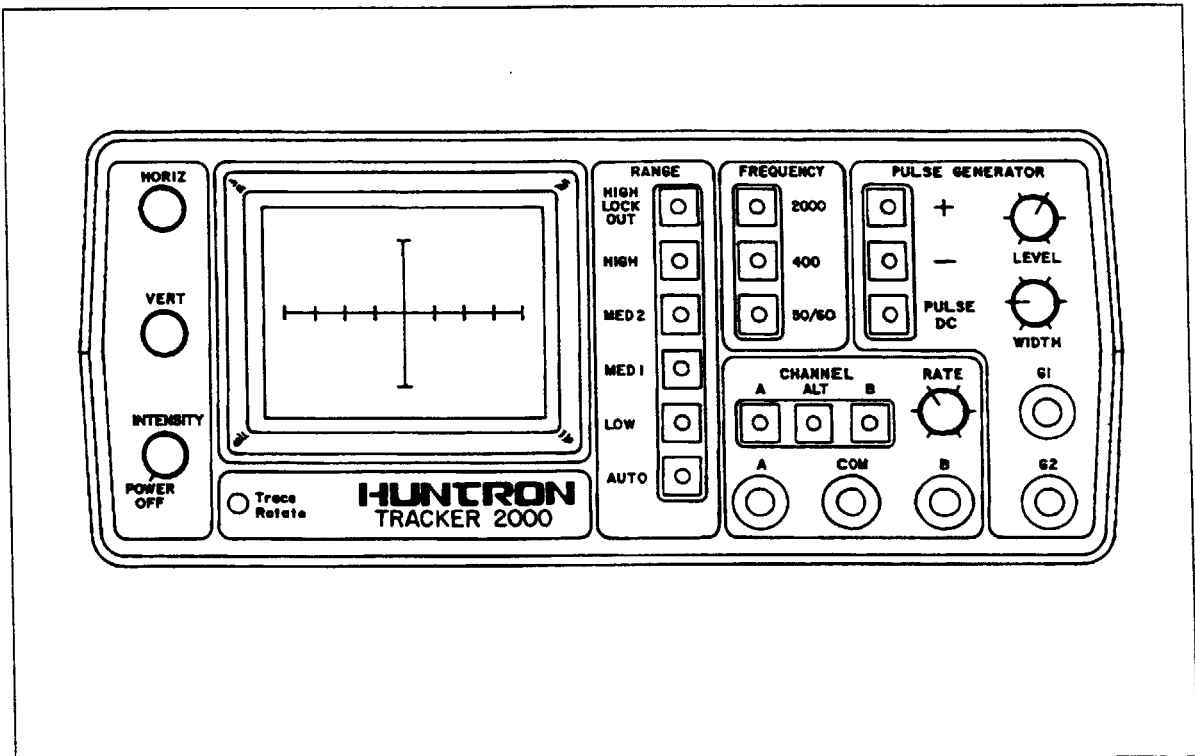

Figure 1-1. Huntron Tracker 2000.



**1-2. SPECIFICATIONS**

The specifications for the Tracker 2000 are listed in Table 1-1.

**Table 1-1  
Tracker 2000 Specifications**

<b>ELECTRICAL</b>		
Unless otherwise specified, all measurements are within $\pm 5\%$		
<b>Impedance Ranges</b>		
Terminal Characteristics:		
<b>Range</b>	<b>Open Circuit Voltage (V<sub>p</sub>)</b>	<b>Short Circuit Current (mA<sub>rms</sub>) <math>\pm 10\%</math></b>
High	60	0.57
Medium 2	20	0.53
Medium 1	15	8.5
Low	10	132
Autoranging Rate ..... adjustable from 0.3 Hz to 5 Hz		
<b>Test Signal</b>		
Waveform ..... sine wave		
Frequencies ..... 50/60 Hz, 400 Hz, 2000 Hz.		
<b>Channels</b>		
Number ..... 2		
Alternation Rate ..... adjustable from 0.5 Hz to 10 Hz		
Overload Protection ..... $\frac{1}{4}$ Amp type AGC internal fuse (operator replaceable)		
<b>Pulse Generator</b>		
Level ..... adjustable from zero to $\pm 5$ VDC ( $\pm 10\%$ ) with respect to instrument common		
DC mode ..... produces positive DC or negative DC		
Pulse mode ..... produces positive pulses, negative pulses, or both		
Frequency ..... same as selected test signal frequency		
Duty Cycle ..... adjustable from ~0% to 50% for each pulse polarity		
Output Impedance ..... 100 $\Omega$ (each output)		
Short Circuit Current ..... 50mA $\pm 10\%$ (each output)		

**Table 1-1 (Con't)**  
**Tracker 2000 Specifications**

## ELECTRICAL (con't)

### Display

Type .....	Monochrome CRT
Size .....	2.8" (7cm) diagonal
Acceleration Potential .....	1320VDC $\pm$ 20VDC (regulated)

### Power Requirements

* AC Line Voltage .....	100VAC, 115VAC, or 230VAC
Frequency .....	47 Hz - 400 Hz
Power .....	20 Watts max
Line Fuse .....	$\frac{1}{4}$ Amp type AGC (internal - operator replaceable)

\* Note: 115VAC and 230VAC are selectable via an internal switch. 100VAC models will only work at that voltage.

## GENERAL

Size .....	9" W x 4" H x 11" D (23cm W x 10cm H x 28cm D)
Weight .....	6 lbs. 8 oz. (3.0 kg)
Shock and Vibration .....	will withstand shock and vibration encountered in commercial shipping and handling.

## ENVIRONMENTAL

Operating Temperature .....	0°C to +50°C (32°F to 122°F)
Storage Temperature .....	-50°C to +60°C (-58°F to +140°F)
Relative Humidity .....	0 to 70% R.H.

### 1-3. SAFETY CONSIDERATIONS

This manual contains information, cautions, and warnings the user must follow to ensure safe operation, and to keep the instrument in safe condition.

#### WARNING

**A warning denotes a hazard. It calls attention to a procedure or practice which, if not correctly performed or adhered to, could result in personal injury.**

#### CAUTION

**A caution also denotes a hazard. It calls attention to a procedure or practice which, if not correctly performed or adhered to, could result in damage to or destruction of part or all of the instrument.**

### 1-4. LIST OF ACCESSORIES

The following accessories are available:

<u>ITEM NUMBER</u>	<u>HUNTRON P/N</u>	<u>NSN#</u>
1	Switcher 410 99-0090	6625-01-164-2224
2	Tracker Trainer 98-0055	-
3	Power Cord (115V/100V) 98-0015	-
4	Power Cord (230V) 98-0016	-
5	Micro Clips 98-0036	-
6	Common Test Clips 98-0043	-
7	Huntron Microprobes 98-0078	-
8	Operation & Maintenance Manual 21-1052	-

To order any of the above items, or for further information, please contact Huntron.

# SECTION 2

## OPERATING INSTRUCTIONS

### 2-1. INTRODUCTION

This section describes the basic operation of the Tracker 2000. Throughout the rest of this manual the Tracker 2000 will be referred to simply as a "2000". Take time to read this section carefully so that you can take full advantage of all of the troubleshooting capabilities of the 2000.

### 2-2. UNPACKING YOUR INSTRUMENT

Your instrument was shipped with two Huntron Microprobes (one red and one black), two common test leads (black), two micro clip leads (blue), a power cord, and this manual. Check the shipment carefully and contact the place of purchase if anything is missing or damaged in shipment. If reshipment is necessary, please use the original shipping carton and packing foam. If these are not available, be sure that adequate protection is provided to prevent damage during shipment. See Section 4-2 for shipping information.

### 2-3. GENERAL OPERATION

Components are tested by the 2000 using a two terminal system (three terminal system when the built-in pulse generator is used), where two test leads are placed on the leads of the component under test. The 2000 tests components in-circuit, even when there are several components in parallel.

The 2000 is only intended for use in boards and systems with all voltage sources in a power-off condition. A 0.25 ampere signal fuse is connected in series with the channel A and B test terminals. Accidental contact of the test leads to active voltage sources (e.g. line voltage, powered-up boards or systems, charged high voltage capacitors, etc.), may cause this fuse to open, making replacement necessary. When the signal fuse blows, short circuit signatures will be displayed even with the test leads open.

#### CAUTION

**The device to be tested must have all power turned off, and have all high voltage capacitors discharged before connecting the 2000 to the device.**

The line fuse should only open when there is an internal failure inside the instrument. Therefore the problem should always be located and corrected before replacing this fuse.

## 2-4. FUSE REPLACEMENT

To replace either fuse, disconnect the 2000 from the power line. Remove the four case screws located on the underside of the case and lift off the top case half (see Section 4-4). The signal fuse is located in back of the front panel on the signal printed circuit board assembly (refer to Figure 6-3). The line fuse is located at the back of the main printed circuit board assembly behind the CRT (refer to Figure 6-2). Replace either fuse with a 0.25A, 250V, type AGC fuse.

## 2-5. PHYSICAL FEATURES

Before you begin to use the 2000, please take a few minutes to familiarize yourself with the instrument. All of the externally accessible features are discussed in Sections 2-6, 2-7 and 2-8.

## 2-6. Front Panel

The front panel of the 2000 is designed to make function selection easy. All push buttons are momentary action and have integral LED indicators that show which functions are active. Refer to Figure 2-1 and Table 2-1 for a detailed description of each item on the front panel.

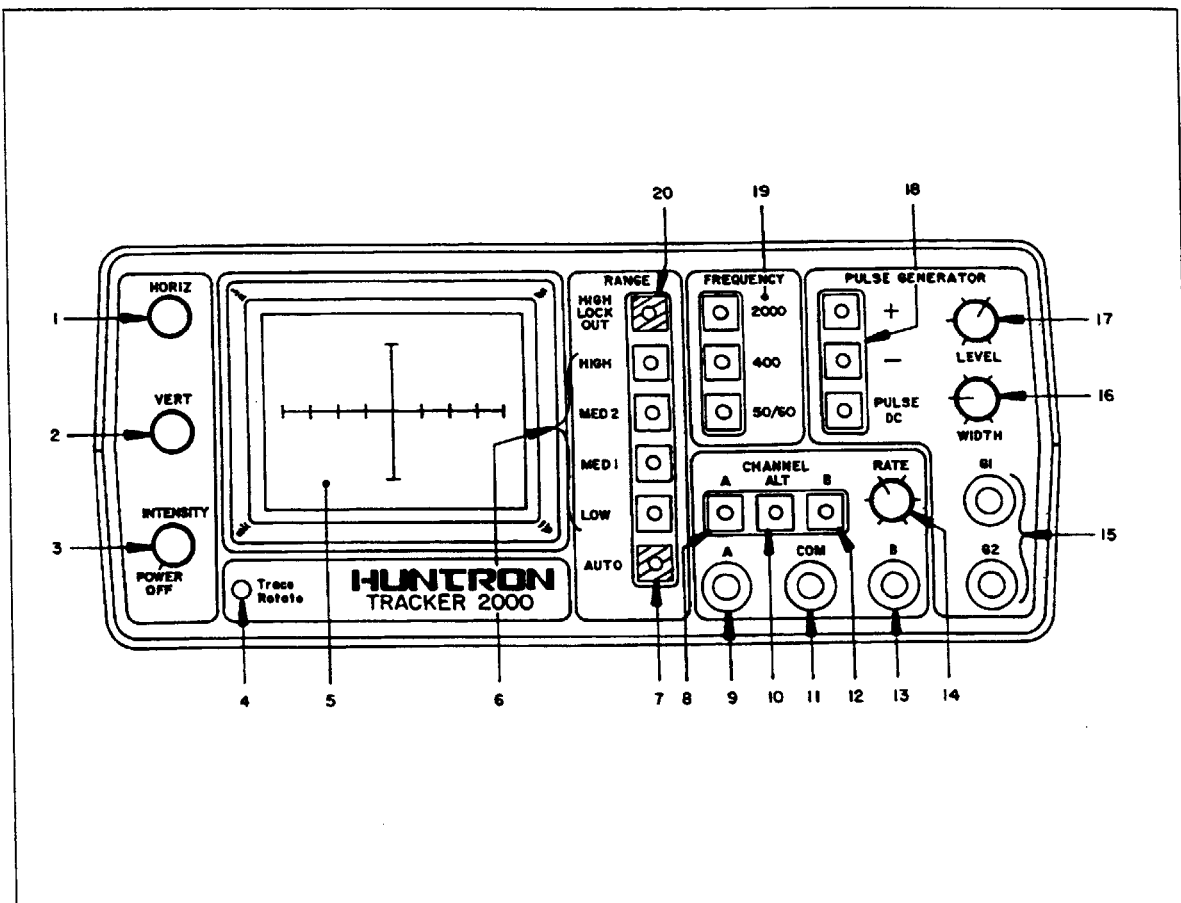

Figure 2-1. Front Panel.

**Table 2-1  
Front Panel Controls and Connectors**

Item No.	Name	Function
1	HORIZ Control	Controls the horizontal position of the CRT display.
2	VERT Control	Controls the vertical position of the CRT display.
3	INTENSITY Control Power On/Off Switch	Controls the intensity of the CRT display. Power Switch: Rotate clockwise to turn on.
4	TRACE ROTATE Control	Controls the trace rotation of the CRT display.
5	CRT Display	Displays the component signatures produced by the 2000.
6	Range Selectors	Push buttons that select one of four impedance ranges: low, medium 1, medium 2, and high.
7	AUTO Switch	Push button that initiates automatic scanning of the four ranges from low to high. The scanning speed is determined by the RATE control (see item #14).
8	Channel A Switch	Push button that causes channel A to be displayed.
9	Channel A Test Terminal	Fused test lead connector that is active when channel A is selected. All test lead connectors accept standard banana plugs
10	ALT Switch	Push button that causes the 2000 to alternate between channel A and channel B at a speed determined by the RATE control (see item #14).
11	COM Test Terminal	Test lead connector that is instrument common and the common reference point for both channel A and channel B.
12	Channel B Switch	Push button that causes channel B to be displayed.
13	Channel B Test Terminal	Fused test lead connector that is active when channel B is selected.
14	RATE Control	Controls the rate of channel alternation and/or range scanning.
15	G1 & G2 Terminals	Pulse generator output test lead connectors.
16	WIDTH Control	Controls the duty cycle of the internal pulse generator.
17	LEVEL Control	Controls the amplitude of the internal pulse generator.
18	Pulse Generator Selectors	Push buttons that select various output modes of the pulse generator: Positive (+), Negative (-), and PULSE/DC.
19	Frequency Selectors	Push buttons that select one of the three test signal frequencies: 50/60 Hz, 400 Hz, and 2000 Hz.
20	HIGH LOCKOUT Switch	Push button that activates a mode where it is not possible to enter the high range either by manual or automatic range selection.

## 2-7. Back Panel

Secondary controls and connectors are on the back panel. Refer to Figure 2-2 and Table 2-2 for a detailed description of each item on the back panel.

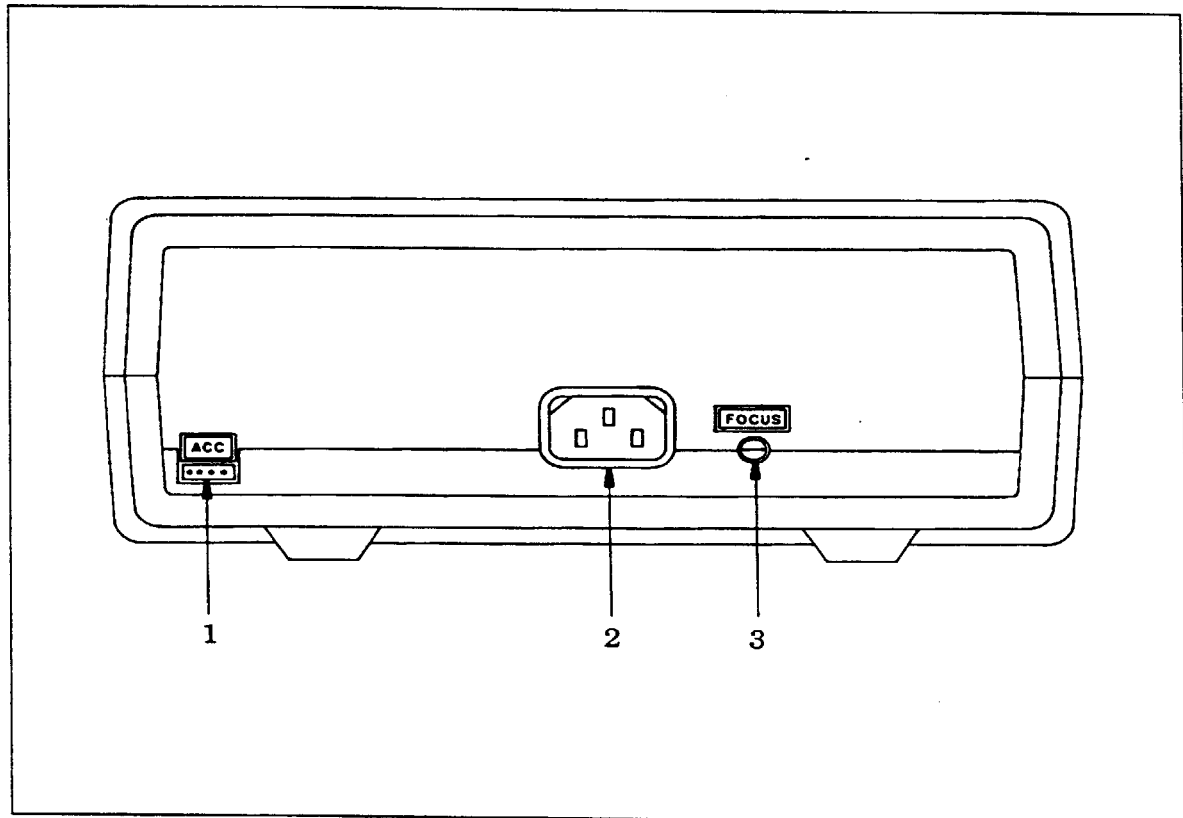

Figure 2-2. Back Panel.

Table 2-2  
Back Panel Controls & Connectors

Item No.	Name	Function
1	Accessory Output Connector	Connector which provides power and clock to the Huntron Switcher Model 410.
2	Power Cord Connector	IEC standard connector that mates with any CEE-22 power cord.
3	FOCUS Control	Controls the focus on the CRT display.

## 2-8. CRT Display

The CRT displays the signature of the components being tested. The display has a graticule consisting of a horizontal axis which represents voltage, and a vertical axis which represents current. The axes divide the display into four quadrants. Each quadrant displays different portions of the signatures. Quadrant 1 displays positive voltage (+V) and positive current (+I), quadrant 2 displays negative voltage (-V) and positive current (+I), quadrant 3 displays negative voltage (-V) and negative current (-I), and quadrant 4 displays positive voltage (+ V) and negative current (-I). See Figure 2-3.

The horizontal axis is divided in eight divisions, which allow the operator to estimate the voltage at which changes in the signature occur. This is mainly useful in determining semiconductor junction voltages under either forward or reverse bias. Table 2-3 lists the approximate horizontal sensitivities for each range.

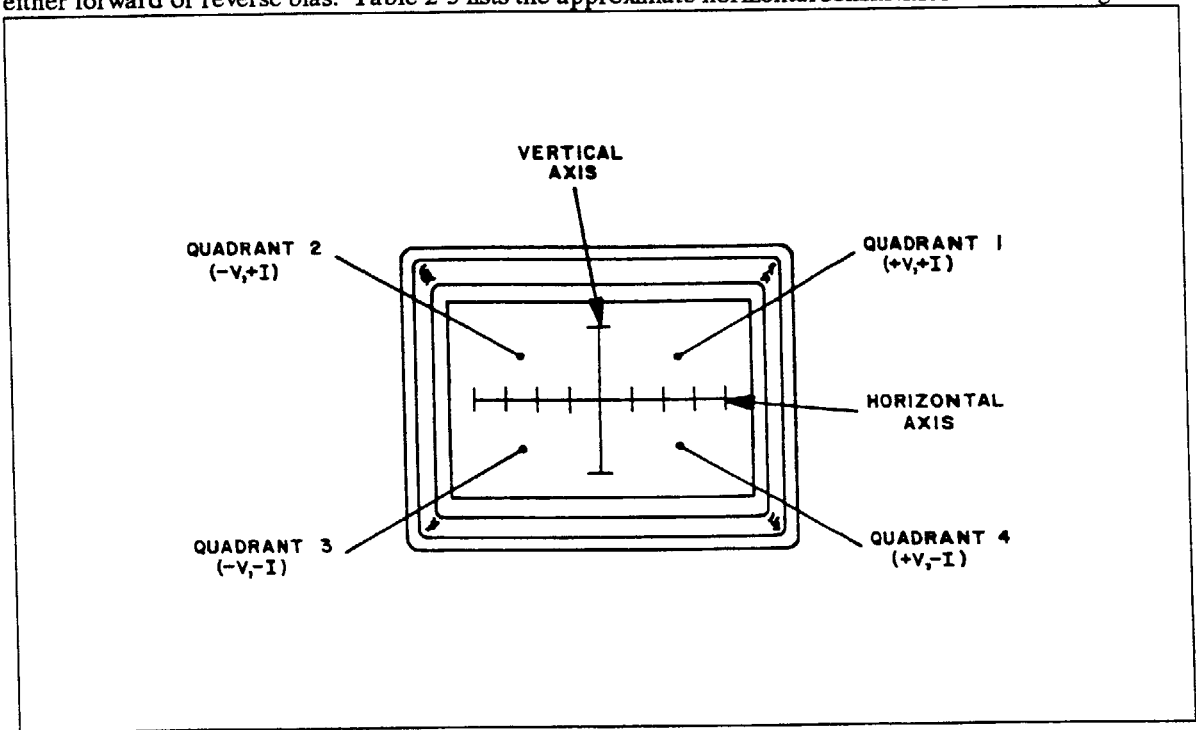

Figure 2-3. CRT Display.

Table 2-3  
Horizontal Sensitivities

Range	Volts/Div
High	~15.0
Medium 2	~5.0
Medium 1	~3.75
Low	~2.5

## 2-9. OPERATION

The following sections explain how to use the front and back panel features. Use Sections 2-6 and 2-7 for the description and location of each control. Signatures of components will be covered in Sections 7 thru 15.



## 2-10. INITIAL SETUP

Turn the Power/Intensity knob clockwise. The 2000 should come on with the LEDs for power, channel A, 50/60 Hz, low range, and pulse/DC illuminated.

Focusing of the 2000 display is important in analyzing the test signatures. This is done by first turning the intensity control to a comfortable level and adjusting the focus control (back panel) for the narrowest possible trace.

Aligning the trace is important in determining which quadrants the portions of a signature are in. With a short circuit on channel A, adjust the trace rotation control until the trace is parallel to the vertical axis. Adjust the horizontal control until the vertical trace is even with the vertical axis. Open channel A, and adjust the vertical control until the horizontal trace is even with the horizontal axis. Once set, these adjustments should not have to be readjusted during normal operation.

The power is turned off by turning the Power/Intensity knob fully counterclockwise.

## 2-11. Range Selection

The 2000 is designed with four impedance ranges (low, medium 1, medium 2, and high). These ranges are selected by pressing the appropriate button on the front panel. It is best to start with one of the medium ranges (i.e. medium 1 or medium 2). If the signature on the CRT display is close to an open (horizontal trace), go to the next higher range for a more descriptive signature. If the signature is close to a short (vertical trace), go the next lower range.

The High Lockout feature, when activated, prevents the instrument from entering the high range in either the manual or Auto mode.

The Auto feature scans through the four ranges (three with the High Lockout activated) at a speed set by the Rate control. This feature allows the user to see the signature of a component in different ranges while keeping hands free to hold the test leads.

## 2-12. Channel Selection

There are two channels on the 2000 (channel A and channel B) which are selected by pressing the appropriate front panel button. When using a single channel, the red probe should be plugged into the corresponding channel test terminal and the black probe should be plugged into the common test terminal. When testing, the red probe should be connected to the positive terminal of a device (i.e. anode, +V, etc.) and the black probe should be connected to the negative terminal of a device (i.e. cathode, ground, etc.). Following this procedure should assure that the signature appears in the correct quadrants of the CRT display.

The Alternate mode of the 2000 is provided to automatically switch back and forth between channel A and channel B. This allows easy comparison between two devices or the same points on two circuit boards. The Alternate mode is selected by pressing the ALT button on the front panel, and the alternation frequency is varied by the Rate control. One of the most useful features of the 2000 is using the Alternate mode to compare a known good device with the same type of device that is of unknown quality. Figure 2-4 shows how the instrument is connected to a known good board and a board under test. This test mode uses the supplied common test leads to connect two equivalent points on the boards to the common test terminal. Note that the black probe is plugged into the channel B test terminal.

When using the Alternate and Auto features simultaneously, each channel is displayed before the range changes. Figure 2-5 shows the sequence of these changes.

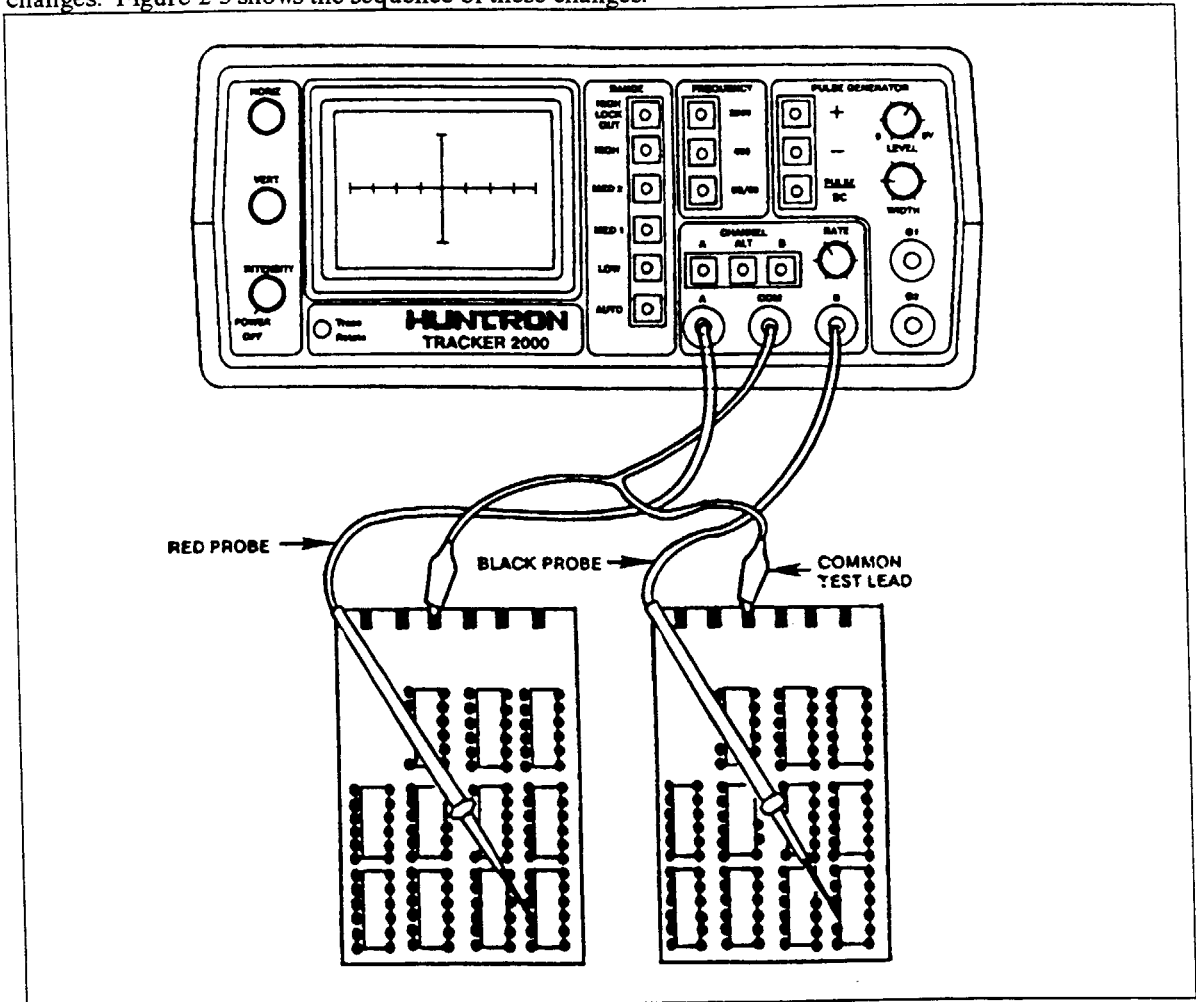

Figure 2-4. Alternate Mode Setup.

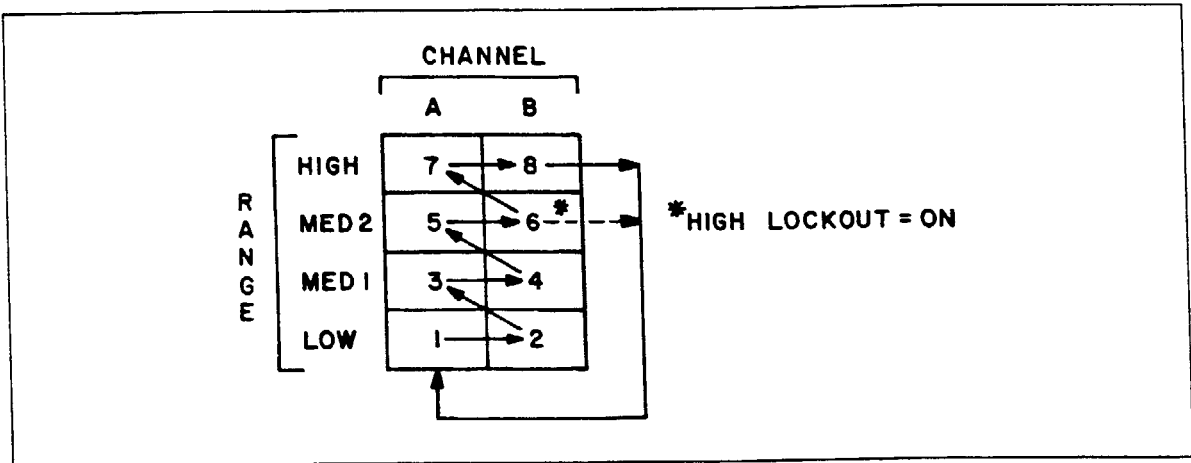

Figure 2-5. Auto/Alternate Sequence.

## 2-13. Frequency Selection

The 2000 has three test signal frequencies (50/60 Hz, 400 Hz and 2000 Hz), which are selected by pressing the appropriate button on the front panel. In most cases the 50/60 Hz test signal is the best to start with. The other two frequencies are generally used to view small amounts of capacitance or large amounts of inductance.

## 2-14. Pulse Generator

The built-in pulse generator of the 2000 allows dynamic, in-circuit testing of certain devices in their active mode. In addition to using the red and black probes, the output of the pulse generator is connected to the control input of the device to be tested with one of the blue micro clips provided. The pulse generator has two outputs (G1 and G2) so that three terminal devices can also be tested in the Alternate mode. Figure 2-7 shows how to hook up the 2000 in the Alternate mode using the pulse generator.

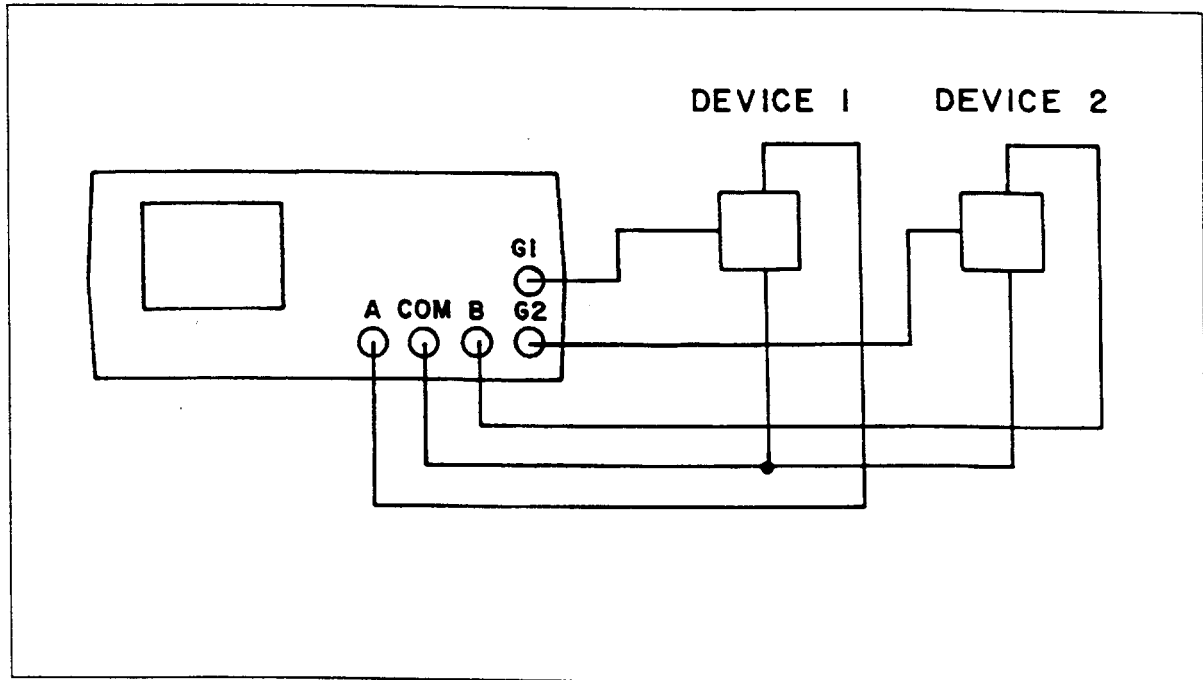

Figure 2-6. Pulse Generator Comparison Mode.

A variety of output waveforms is available using the pulse generator selector buttons as shown in Figure 2-7. First select the Pulse mode or the DC mode using the PULSE/DC button. In Pulse mode, the LED flashes at a slow rate, while in DC mode, the LED is continuously on. Then select the polarity of output desired using the positive (+) and negative (-) buttons. All three buttons function in a "push-on/push-off" mode and only interact with each other to avoid the NOT ALLOWED state.

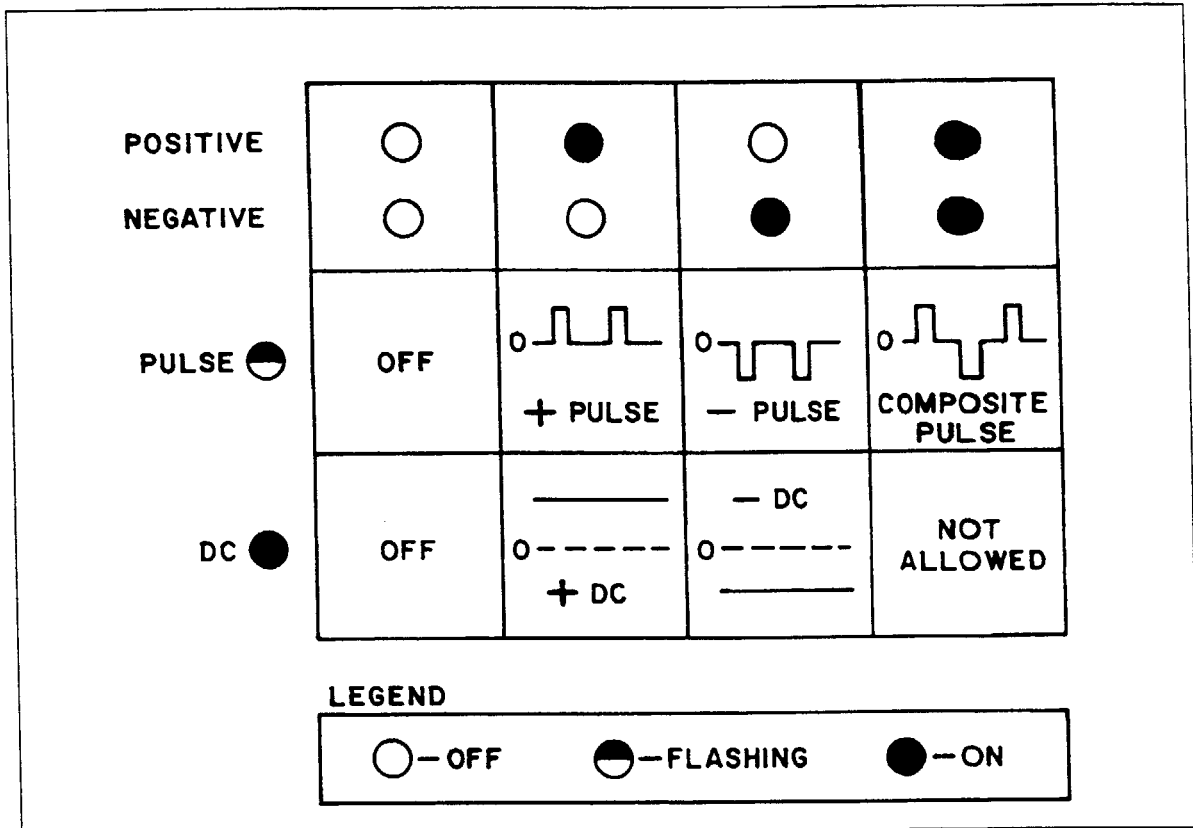

Figure 2-7. Pulse Generator Selector Chart.

Once the specific output type is selected, the exact output is set using the Level and Width controls. The Level control varies the magnitude of output amplitude from zero to 5 volts (peak or DC). During Pulse mode, the Width control adjusts the duty cycle of the pulse output from a low duty cycle to 50% maximum (square wave). The start of a pulse is triggered by the appropriate zero crossing of the test signal which results in the pulse frequency being equal to the selected test signal frequency. The end of a pulse is determined by the Width control setting which selects the duty cycle. The Width control has no effect when DC mode is selected.

## 2-15. HUNTRON SWITCHER 410 CONNECTIONS

Refer to Figure 2-8 for the interconnection diagram to use the Huntron Switcher 410 with the 2000. The two terminals marked TRACKER on the 410 are connected to either channel of the 2000 using the double banana plug cable supplied with the 410. Select the channel the Switcher is connected to. The accessory cable, which comes with the 410, is connected between the Accessory output connector (2000 back panel) and the two jacks on the 410 marked INPUT 8VDC-12VDC and EXT CLK. Each of the three connectors on the cable are different so that the cable can only be hooked up the correct way.

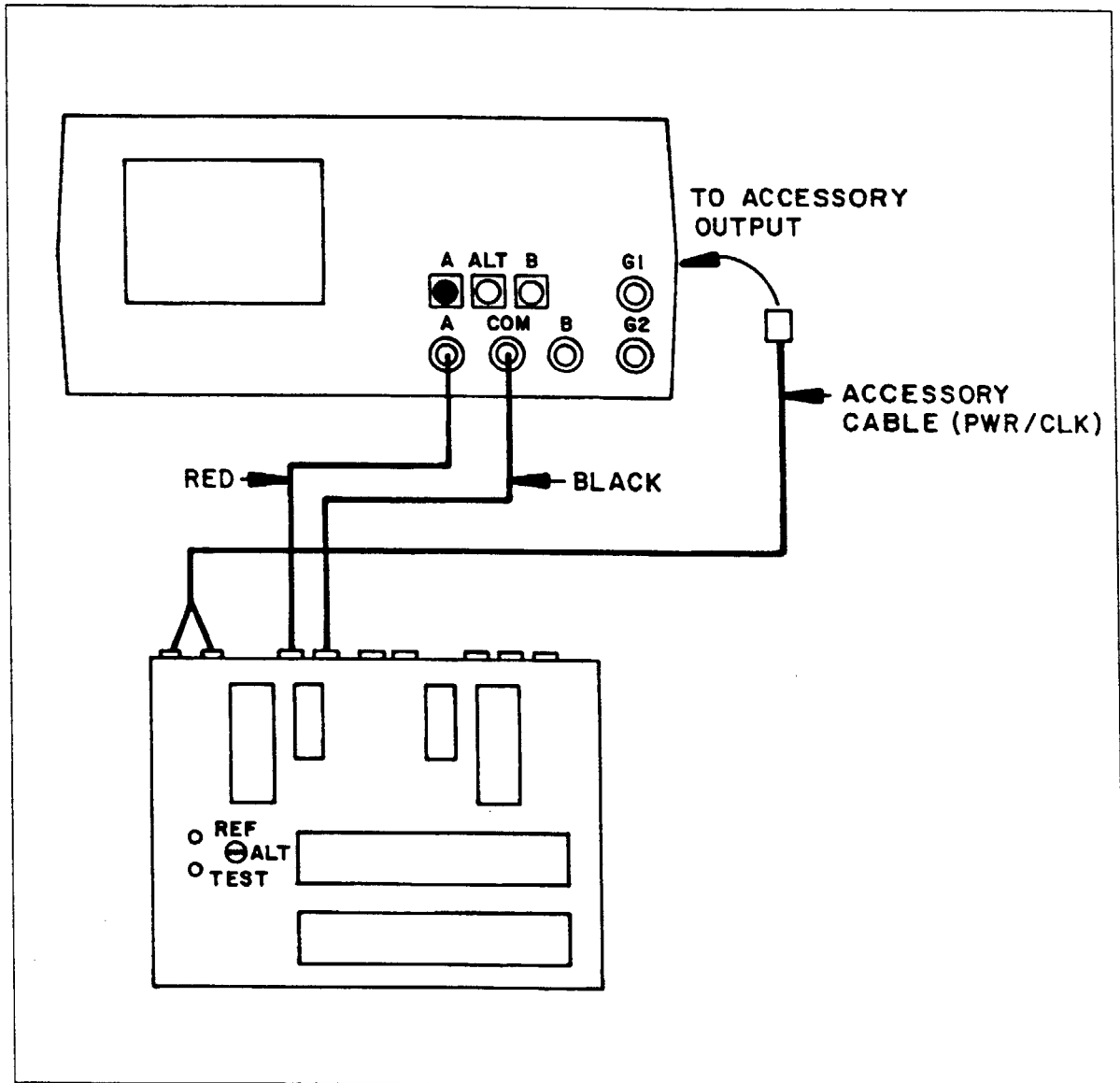

Figure 2-8. 2000/Switcher Interconnection.

The setup procedure supplies the 410 with power and a clock signal controlled by the Rate control on the 2000. To use the 410, set the TRACKER/OFF/EXTERNAL switch to TRACKER which illuminates the TRACKER LED. The REF/ALT/TEST switch when set to either REF or TEST is used in the normal manner, i.e. the selected device is continuously connected through the 410 to the 2000 and signatures can

be viewed by selecting a common pin and pressing the button for a particular IC pin number. When the REF/ALT/TEST switch is set to ALT, the 410 will alternate between the reference device and the test device at a frequency determined by the Rate control of the 2000. The Rate control on the 410 is disabled in this mode. If the Auto scanning feature of the 2000 is activated, the alternation rate of the 410 will be synchronized with the range scanning rate of the 2000. This activates a similar scanning sequence to that shown in Figure 2-5, except that forty different points on two devices can be easily examined instead of one point on two devices with the 2000 alone.

For best results, the 50/60 Hz test signal frequency should be selected when using the 410.

## 2-16. TRACKER TRAINING

A demonstration and training board and manual are available from Huntron which provides the user with more instruction on the basic operation of the instrument and helps the user become more familiar with signatures produced by the 2000.

For ordering and further information, refer to Section 1-4 in this manual or contact Huntron.

## 2-17. EXTERNAL CLEANING AND LUBRICATION

### WARNING

**To avoid electric shock or instrument damage, never get water inside the case.  
To avoid instrument damage, never apply solvents to the instrument.**

Should the 2000 case require cleaning, wipe the instrument with a cloth that is lightly dampened with water or mild detergent solution. The 2000 requires no lubrication.

## 2-18. STORAGE INSTRUCTIONS

For optimum protection, store unit indoors in a dry place.

**OPERATING INSTRUCTIONS**

**NOTES:**

# SECTION 3

## THEORY OF OPERATION

### 3-1. INTRODUCTION

This section describes how the 2000 works. An overview of the operation is provided first, followed by descriptions of the major sections of the circuit and their function. Detailed schematics of the 2000 appear in Section 6.

### 3-2. FUNCTIONAL OVERVIEW

The major circuits of the 2000 are arranged in a block diagram in Figure 3-1. The control logic selects the appropriate channel, frequency, impedance range, and pulse generator mode according to the front panel buttons pushed by the operator. The oscillator provides the test signal used by the signal section and the pulse generator. In the signal section, the test terminals are driven by the test signal while signal conditioners monitor the terminals and produce the horizontal and vertical signals used to produce a component signature on the CRT display. The pulse generator provides an added source of stimulus for testing three terminal devices. The power supply produces voltages for CRT acceleration, deflection, and filament as well as the low voltage general purpose supply used by all other sections of the circuit. These circuits will be described in more detail in this section.

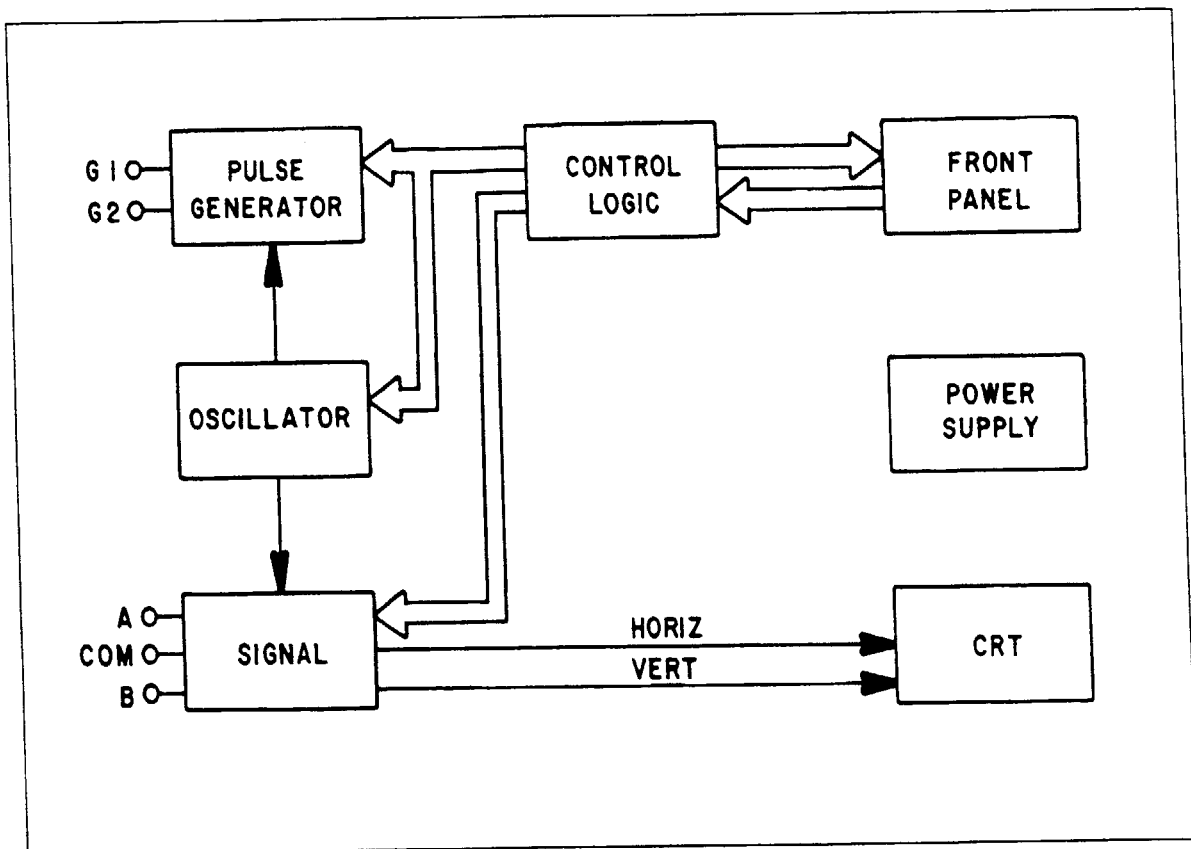

Figure 3-1. 2000 Block Diagram.



### 3-3. Control Logic

The control logic senses which button is pushed through input lines connected to the front panel push buttons. Since the push buttons are the momentary action type, the logic must remember which button was pushed, turn on the LED indicator in the button, and activate the appropriate configuration of the oscillator, signal section, and pulse generator. After a button is pushed, the 2000 will remain in that configuration until another button is pushed or the power is turned off. Most of the buttons operate in a "latched until cancelled by another button" mode, except for the High Lockout feature and the pulse generator buttons which turn on and off only with repetitive pushes of their respective buttons.

The channel buttons, A, ALT, and B affect the channel relay. The relay is a single pole, double throw type and is de-energized for channel A and energized for channel B. If channel A is already active and the channel B button is pressed, channel A will be cancelled and channel B selected and vice versa. When the ALT button is pushed, another control line is set which enables an internal clock to toggle the channel relay on and off thereby alternating between channel A and B. The internal clock is controlled by the front panel Rate control. When ALT mode is active, the LEDs within the A and B buttons flash alternately and the ALT LED is continuously on. Pressing either channel button cancels the ALT mode and the relay is forced to the selected channel.

The frequency buttons 50/60, 400, and 2000 (Hz) latch control lines F1, F2, and F3 respectively. These lines directly control the operation of the oscillator and the pulse generator.

The range buttons, LOW, MEDium 1, MEDium 2, and HIGH, latch control lines RS1, RS2, RS3, and RS4 respectively. These four lines control the four relays in the signal section that select the appropriate terminal characteristics for each impedance range.

The four ranges can be selected manually by pressing a particular range button, or they can be scanned automatically using the Auto function. When Auto is activated, the control logic will follow the sequence low, medium 1, medium 2, high, low, medium 1, etc. if High Lockout is off. The current active range is always indicated by which range LED is on. Once activated, the 2000 will remain in Auto until the operator manually selects a range which cancels the Auto function. While Auto is active, the AUTO LED is continuously on. The speed at which the ranges are scanned is controlled by the front panel Rate control so that the operator may adjust the time each range is displayed according to individual desires. If Auto and Alternate are active at the same time, the Rate control affects the speed of both functions with Alternate having priority. This is done so that the two channels can be compared to each other within one range before the next range is selected (see Figure 3-2).

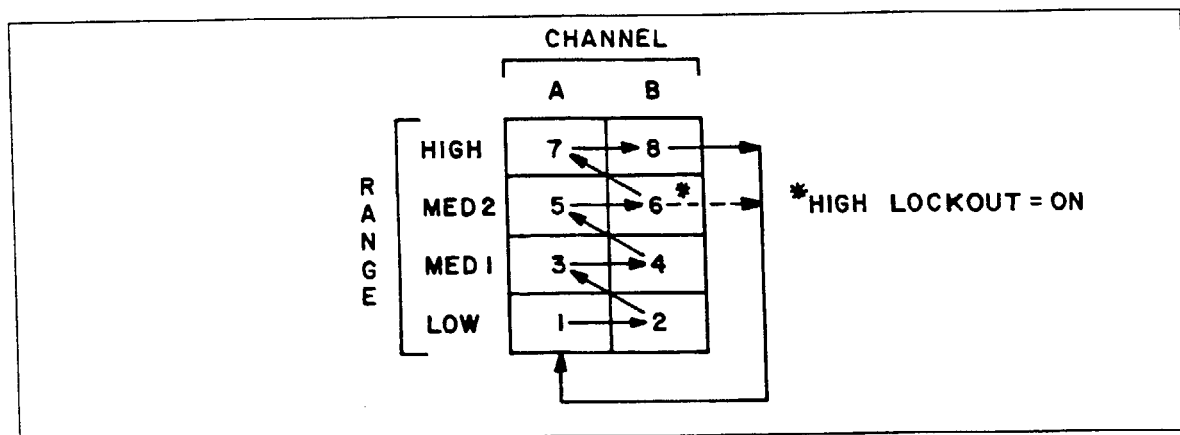

Figure 3-2. Range Scanning Sequence With AUTO and ALT Active.

The High Lockout function disables the high range and limits the maximum test signal to  $20V_p$  rather than  $60V_p$ . The HIGH LOCKOUT button toggles on/off, i.e., one press turns it on and another press turns it off. No other button on the front panel affects this one so it cannot be unintentionally turned off. Detailed operation is as follows: in manual mode (Auto = Off), activating High Lockout prevents the high range from being selected and, if the high range is active when the HIGH LOCKOUT button is pressed, the high range is cancelled and the next lower range, medium 2, is selected. In Auto mode, the range sequence is changed to low, medium 1, medium 2, low, etc., bypassing the high range. Also pressing the HIGH button will not cancel the Auto function and return the 2000 to manual mode.

The pulse generator buttons, positive (+), negative (-), and PULSE/DC toggle control lines PS1, PS2, and PS3 respectively. These lines control the polarity and output type of the pulse generator.

At power up, the initial conditions of the control logic are low range, 50/60 Hz, channel A, DC mode, with Auto, Alternate, High Lockout, positive and negative turned off.

### 3-4. Oscillator

The oscillator is located on the signal PCB which is mounted above the main PCB. This circuit produces a constant amplitude, low distortion sine wave test signal. The frequency of the test signal is programmable between one variable frequency (50/60 Hz), and two fixed frequencies (400 Hz and 2000 Hz). The signals are first generated as triangle waves and then converted to sine waves using a wave shaping circuit. The variable frequency, 50/60 Hz, depends on the frequency of the power line used with the 2000: a 50 Hz line produces a 50 Hz test signal and a 60 Hz line produces a 60 Hz test signal. If a 400 Hz power line is used, an 80 Hz test signal is provided. This is done so that the operator will always have low, medium, and high frequencies to work with.

### 3-5. Signal Section

The balance of the signal PCB contains the signal section which is really the heart of the 2000. In the signal section, the test signal from the oscillator is applied across two terminals of a device being tested via the front panel test terminals. The test signal causes a current to flow through the device and a voltage drop across its terminals. The current flow causes a vertical deflection of the CRT trace, while the voltage across the device causes a horizontal deflection of the CRT trace. The combined effect produces the current-voltage signature of the device on the CRT display.

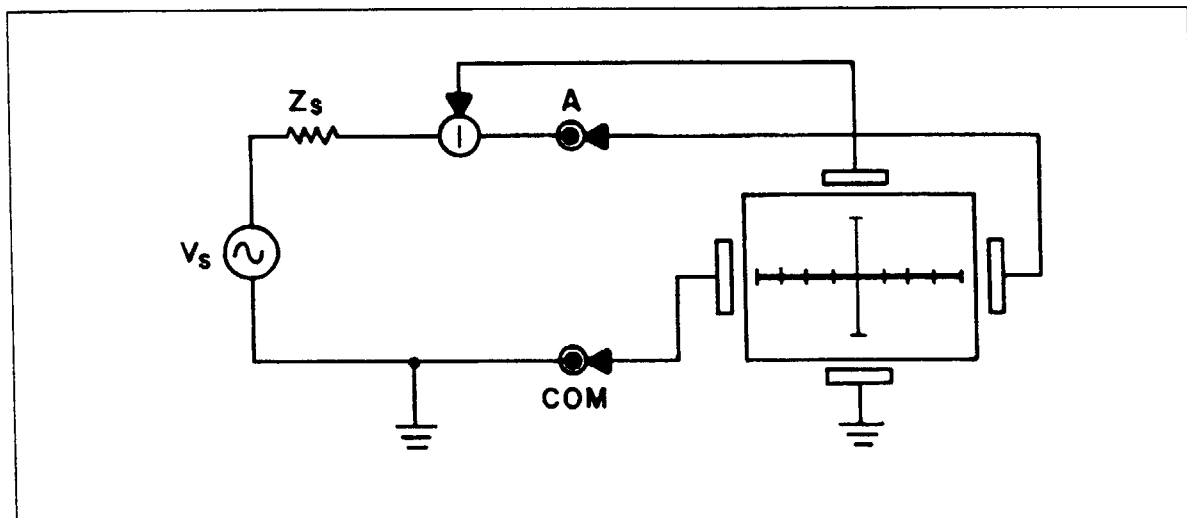

Figure 3-3. Signal Section Equivalent Circuit.

Electrically, the test signal appears at the front panel test terminals as though it is being originated by a voltage source ( $V_s$ ) with a series output impedance ( $Z_s$ ). An equivalent circuit of the signal section is shown in Figure 3-3. The figure also shows how the terminal voltage affects the horizontal deflection plates of the CRT, and how the current through the terminals affects the vertical deflection plates through current sensing point I. The open circuit voltage and output impedance for each range are shown in Table 3-1.

**Table 3-1**  
**Terminal Characteristics**

Range	$V_s$ (peak volts)	$Z_s$
High	60	74k $\Omega$
Medium 2	20	27k $\Omega$
Medium 1	15	1.2k $\Omega$
Low	10	54 $\Omega$

An open circuit has zero current flowing through the terminals and has maximum voltage across the terminals. In all ranges this is represented by a horizontal trace from the left to the right of the CRT graticule (see Figure 3-4a). When the terminals are shorted, maximum current flows through the terminals; the voltage at the terminal is zero. This is indicated by a vertical trace from the top to the bottom of the CRT graticule in all ranges (see Figure 3-4b). Signatures of components will be covered in the second half of this manual (Sections 7 through 15).

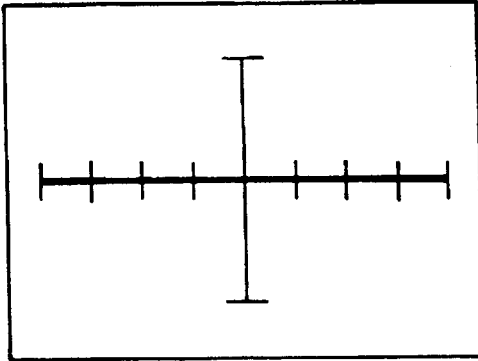

Figure 3-4a. Open Circuit Display All Ranges.

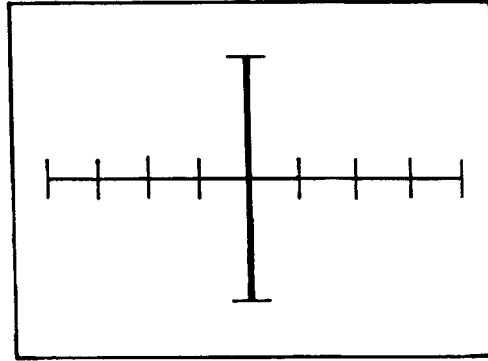

Figure 3-4b. Short Circuit Display All Ranges.

### 3-6. Pulse Generator

The pulse generator is used to drive the control input of a device under test which provides a dynamic test for certain types of devices. The normal two terminal mode of using the 2000 can be thought of as a static test since devices with three or more terminals are not tested in their active mode. However, with the pulse generator, an in-circuit active test of a device is possible. Figure 3-5 shows the equivalent circuit of the pulse generator and the signal section with the CRT connections removed for clarity. The operation of the pulse generator buttons is described in Section 2-14.

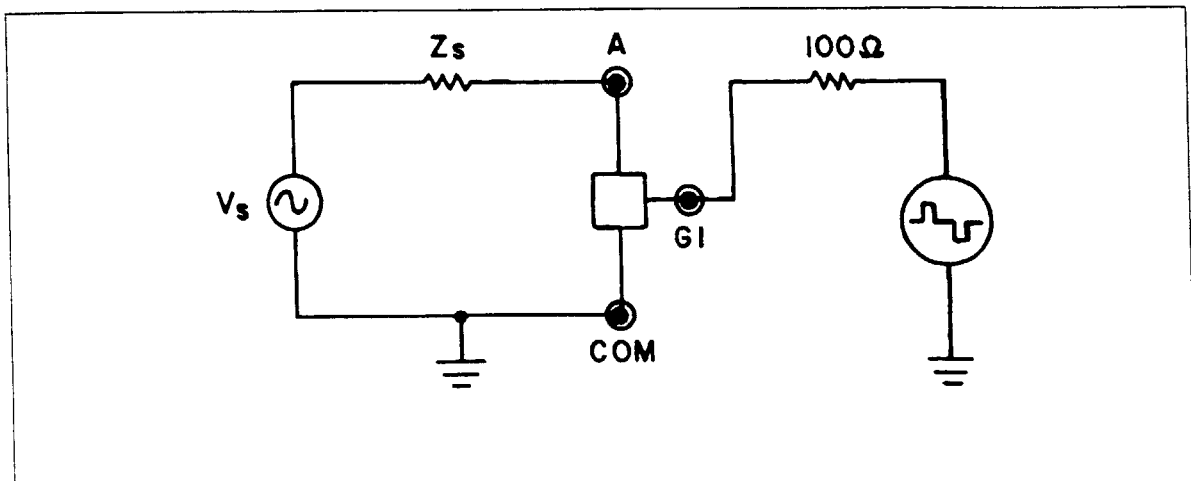

Figure 3-5. Pulse Generator/Signal Section Equivalent Circuit.

In pulse mode, this circuit uses the zero crossings of the test signal to trigger the start of a pulse. When positive (+) is enabled, a positive-going zero crossing triggers a positive pulse. When negative (-) is enabled, a negative-going zero crossing triggers a negative pulse. If both polarities are enabled, then both positive and negative pulses are produced on alternate zero crossings (composite pulses). Once triggered, the duration of a pulse is set by the width control. Figure 3-6 shows the waveforms for the three pulse polarity types at various settings of the width control.

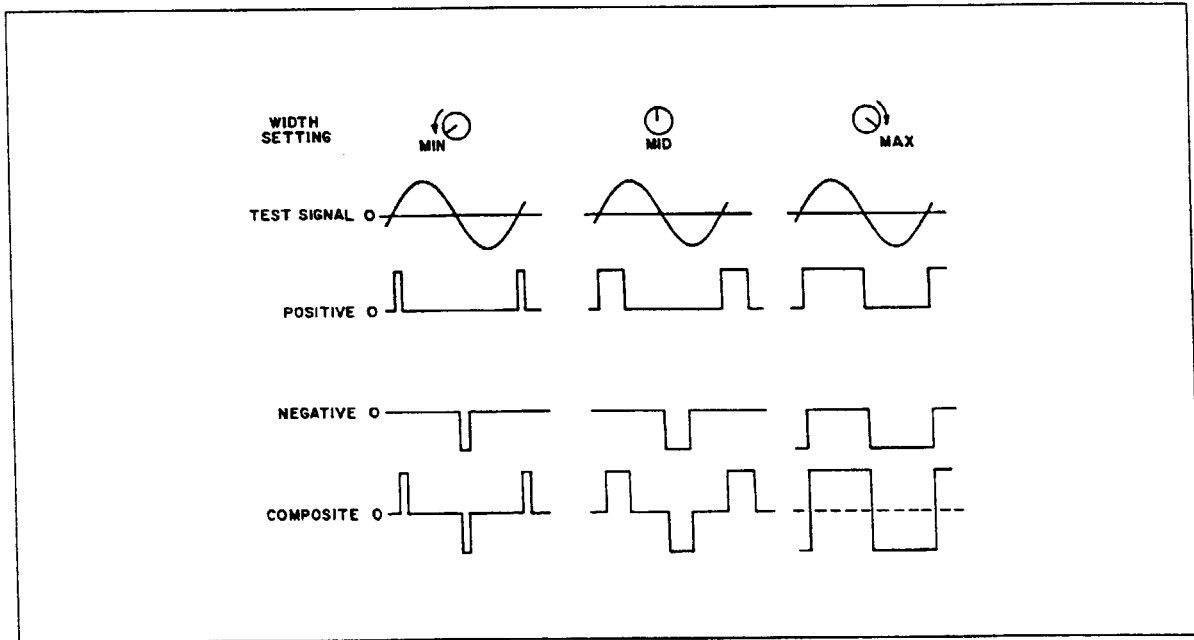

Figure 3-6. Pulse Generator Waveforms.

The Level control adjusts the peak of each pulse from zero to 5 Volts in absolute magnitude with the polarity dependent on the pulse polarity type selected. The maximum open circuit outputs are, therefore, 5 Volts peak-to-peak with either positive or negative enabled, and 10 Volts peak-to-peak when the composite pulse is active.

When DC mode is selected, a zero to 5 Volt DC level is produced at G1 and G2. The polarity is again controlled by the positive and negative buttons. Pressing the positive button enables a positive DC output and disables the negative button. The negative button enables a negative DC output only when positive is off. Using this configuration, it is easy to change polarities with only one button: first press the negative button (which is remembered by the control logic) then press the positive button which switches the output polarity to positive. The next time the positive button is pressed, the positive output is turned off which re-enables the negative output. Therefore, each time the positive button is pressed the output polarity will toggle back and forth between positive and negative. The Width control has no effect in DC modes.

### 3-7. CRT Display

The CRT deflection drivers boost the low level outputs from the signal section to the higher voltage levels needed by the deflection plates in the CRT. The HORIZONTAL and VERTICAL controls on the front panel adjust the position of the CRT trace. The TRACE ROTATE control on the front panel is used to adjust the short circuit vertical trace to be parallel with the vertical axis on the CRT graticule after changes caused by the magnetic field of the Earth. Three other CRT controls are used to adjust the brightness and clarity of the trace: INTENSITY, FOCUS, and astigmatism. The front panel intensity control is the primary means of adjusting the visual characteristics of the trace. Focus is located on the back panel and is an operator trimming adjustment. Astigmatism is an internal adjustment (R40 on the main PCB) and is set at the factory.

### 3-8. Power Supply

This is an AC line operated power supply that is turned on by turning the Power/Intensity knob on the front panel clockwise.

The low voltage power supply provides outputs of  $\pm 12\text{VDC}$  (nominal) and  $\pm 5\text{VDC}$  (regulated) for the oscillator, pulse generator, signal section, and control logic.

The other outputs of the power supply are related to the CRT display. The filament voltage is  $6.3\text{V}_{\text{rms}}$ . There is a  $+ 180\text{VDC}$  output which is primarily used by the deflection driver circuits. Finally, there is a regulated  $-1320\text{VDC}$  output for the CRT acceleration voltage.

### 3-9. VOLTAGE AND POWER CONSIDERATIONS

Sometimes users of the 2000 are concerned that the voltage across a device under test may cause damage to the device. It is therefore important to remember that the voltage specification for each range is only the OPEN CIRCUIT VOLTAGE ( $V_{OC}$ ). When a device is connected to the test terminals, the actual peak voltage that appears across the device will depend on the impedance of the device and how it loads the source resistance of a particular range. For example, when a 5 Volt zener diode is connected to the LOW range ( $V_{OC} = \pm 10\text{V}$ ), the maximum voltage in the reverse direction is the zener voltage because of the  $54 \Omega$  source resistance. In the forward direction a zener diode looks like a regular silicon diode and it conducts with  $V_f = 0.6\text{V}$ . So even though a  $\pm 10$  Volt signal is applied to the zener, the actual peak voltages are  $-5\text{V}$  and  $+ 0.6\text{V}$ . Even when the HIGH range is selected which has  $\pm 60\text{V}$  ( $V_{OC}$ ), the maximum voltages across the zener are still  $-5\text{V}$  and  $+ 0.6\text{V}$ .

If the voltage is not a problem for most common components, what about power? The following sections discuss the power dissipated in the device under test for several cases.

### 3-10. Power in a Resistor

With a resistive load, circuit theory says that maximum power transfer occurs when the load impedance is matched to the source impedance ( $R_L = R_S$ ).

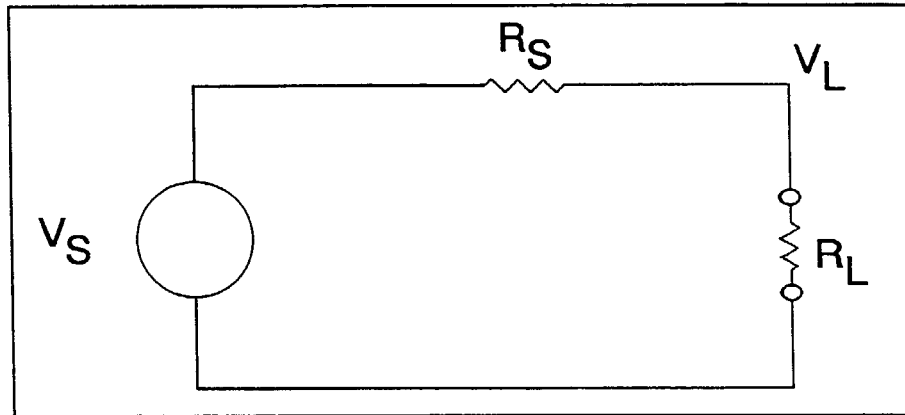

Figure 3-7. Resistor Test Circuit.

When  $R_L = R_S$ , the source voltage ( $V_S$ ) is divided in half at the terminals so that:

$$(1) V_L = \frac{V_S}{2}$$

When  $V_S$  is a sine wave, the power dissipated in  $R_L$  is:

$$(2) P_D = \frac{V_L^2}{2R_L}$$

where  $V_L$  is measured in peak volts.

Using equation (1) to substitute for  $V_L$  in equation (2):

$$(3) P_D = \frac{\left(\frac{V_S}{2}\right)^2}{2R_L} = \frac{V_S^2}{8R_L}$$

This is the equation for the maximum power in  $R_L$ . Using the data for  $V_S$  and  $R_S$  from Table 3-1, the maximum power for each range can be calculated:

$$\text{HIGH} - P_{\text{MAX}} = \frac{(60\text{V})^2}{8(74\text{k}\Omega)} = 6.08\text{mW}$$

$$\text{MED 2} - P_{\text{MAX}} = \frac{(20\text{V})^2}{8(27\text{k}\Omega)} = 1.85\text{mW}$$

$$\text{MED 1} - P_{\text{MAX}} = \frac{(15\text{V})^2}{8(1.2\text{k}\Omega)} = 23.4\text{mW}$$

$$\text{LOW} - P_{\text{MAX}} = \frac{(10\text{V})^2}{8(54\Omega)} = 231\text{mW}$$

where  $54\Omega$ ,  $1.2k\Omega$ ,  $27k\Omega$ , and  $74k\Omega$  are the source impedances of LOW, MED1, MED2, and HIGH, respectively.

This shows that the worst case power for a resistor (i.e. LOW range with a  $54\Omega$  resistor) is less than one quarter of a Watt.

### 3-11. Power in a Diode

The next component to examine is the diode which rectifies the AC test signal so that the current flowing in the diode is a half-wave rectified sine wave.

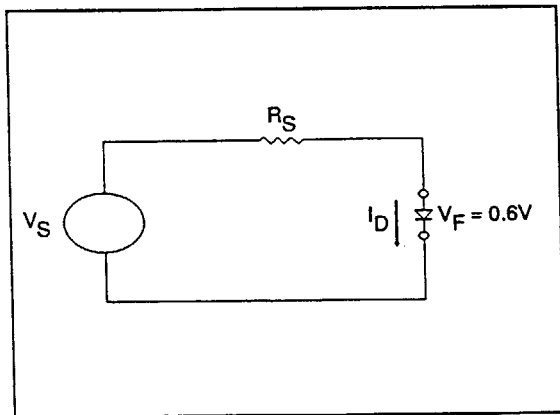

Figure 3-8a. Diode Test Circuit.

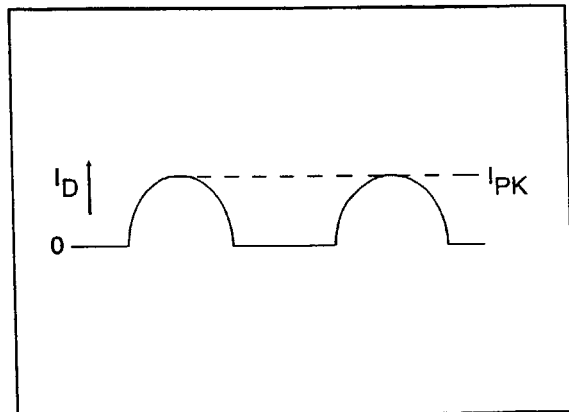

Figure 3-8b. Diode Current Waveform.

The average power dissipated in a diode is approximately equal to the product of forward voltage drop and average current. The average current for a half-wave sine wave is:

$$(1) I_{AVE} = \frac{I_{PK}}{\pi}$$

The peak diode current in the test circuit above is:

$$(2) I_{PK} = \frac{(V_S - 0.6)}{R_S}$$

Using equations (1) and (2) and the formula for power in a diode:

$$(3) P_D = V_F(I_{AVE}) = 0.6V \left( \frac{I_{PK}}{\pi} \right) = \frac{0.6V (V_S - 0.6V)}{\pi R_S}$$



## THEORY OF OPERATION

Using Table 3-1, diode power can be calculated for each range:

$$\text{HIGH} - P_{\text{DIODE}} = \frac{0.6 (60 - 0.6)}{\pi (74\text{k}\Omega)} = 0.15\text{mW}$$

$$\text{MED 2} - P_{\text{DIODE}} = \frac{0.6 (20 - 0.6)}{\pi (27\text{k}\Omega)} = 0.14\text{mW}$$

$$\text{MED 1} - P_{\text{DIODE}} = \frac{0.6 (15 - 0.6)}{\pi (1.2\text{k}\Omega)} = 2.3\text{mW}$$

$$\text{LOW} - P_{\text{DIODE}} = \frac{0.6 (10 - 0.6)}{\pi (54\Omega)} = 33\text{mW}$$

In this case the worst case power dissipated in a diode (LOW range) is less than one twentieth of a Watt.

### 3-12. Power in a Zener Diode

The final example we will look at is the zener diode. This is not just for the case of a discrete zener on a PCB but also because many signatures of integrated circuits resemble the signature of the zener diode and the IC will dissipate the same amount of power as a zener. The actual power in a zener depends on the zener voltage so we will look at a typical zener and use  $V_Z = 5$  Volts for our example.

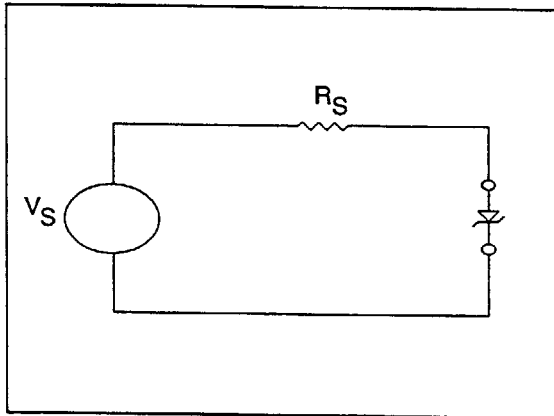

Figure 3-9a. Zener Diode Test Circuit.

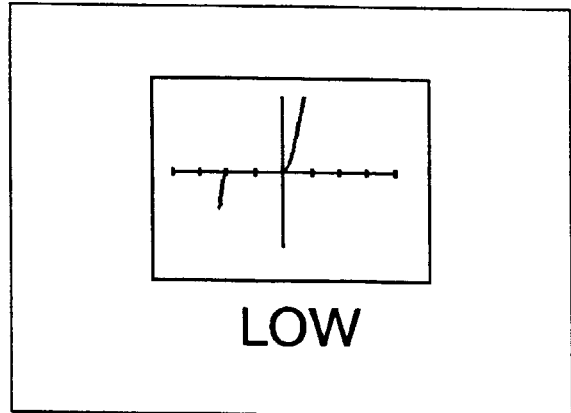

Figure 3-9b. Zener Diode Signature.

In the forward direction a zener diode is equivalent to a silicon diode so the power calculations for the single diode above are part of the answer for the zener. We need to add in the power contribution for the half cycle when the diode turns on at the zener voltage. This power is given by:

$$P_D = V_Z (I_{\text{AVE}})$$

The calculation of  $I_{\text{AVE}}$  for this case is somewhat complex so the values have been provided in the following calculation of total zener power for each range:

$$\text{HIGH} - P_{\text{ZENER}} = 0.15\text{mW} + 5\text{V} (0.23\text{mA}) = 0.15\text{mW} + 1.15\text{mW} = 1.30\text{mW}$$

$$\text{MED 2} - P_{\text{ZENER}} = 0.14\text{mW} + 5\text{V} (0.15\text{mA}) = 0.14\text{mW} + 0.75\text{mW} = 0.89\text{mW}$$

$$\text{MED 1} - P_{\text{ZENER}} = 2.3\text{mW} + 5\text{V} (2.1\text{mA}) = 2.3\text{mW} + 10.5\text{mW} = 12.8\text{mW}$$

$$\text{LOW} - P_{\text{ZENER}} = 33\text{mW} + 5\text{V} (20.2\text{mA}) = 33\text{mW} + 101\text{mW} = 134\text{mW}$$

Again, the worst case power (LOW range) is small - less than one fifth of a Watt.

The aim of these sections has been to show that the power levels used by the 2000 are so low that no damage to the device under test should occur. For more information, see Appendix A and Appendix B at the back of this manual. They provide actual test results from using a Tracker on several types of IC logic.

**THEORY OF OPERATION**

**Notes:**

# SECTION 4 MAINTENANCE

## WARNING

**These service instructions are for use by qualified service personnel only. To avoid electric shock, do not perform any procedures in this section unless you are technically qualified to do so.**

### 4-1. INTRODUCTION

This section presents maintenance information for the 2000. The section includes service information, disassembly/reassembly instructions, performance tests, internal adjustments, and troubleshooting information.

### 4-2. SERVICE INFORMATION

The conditions of the 2000 warranty are given at the front of this manual. Malfunctions that occur within the limits of the warranty will be corrected at no cost to the purchaser exclusive of one-way shipping costs to Huntron Instruments, Inc. Huntron service is also available for calibration and/or repair of instruments that are beyond the warranty period. In either case, please describe clearly the problems encountered with the instrument.

For in-warranty or out of warranty factory service in the United States, call (toll-free) 800-426-9265 and receive an RMA number and shipping instructions prior to shipment. This number must be clearly displayed on the exterior of the shipping carton. Only parcels displaying an RMA number will be accepted. In Washington State, call 206-743-3171.

When packing the unit for shipment, use the original shipping container to provide protection during transit. If original container is not available, package the unit in a box with a minimum of two inches (5 cm) of cushioning material on all sides.

### 4-3. CMOS HANDLING PRECAUTIONS

#### CAUTION

**This instrument contains CMOS components which can be damaged by static discharge.**

To prevent damage, take the following precautions when troubleshooting and/or repairing the instrument:

- Perform all work at a static-free work station.
- Do not handle components or PCB assemblies by their connectors.
- Wear static ground straps.
- Remove all plastic, vinyl and styrofoam from the work area.
- Use a grounded, temperature-regulated soldering iron.

## 4-4. DISASSEMBLY PROCEDURE

### WARNING

To avoid electric shock, remove the power cord and test leads before disassembling the instrument.

The following paragraphs present a disassembly procedure for the 2000. The procedure should be performed in the order presented.

Remove the case top first, then remove the CRT assembly, Power transformer, Signal PCB assembly, Main PCB assembly, and Front Control assembly.

### Case Top Removal:

Refer to Figure 4-1.

1. Turn unit over and place on a flat surface. Remove four screws (1.MP5) from case bottom.
2. While holding both case top and bottom, turn unit right side up. Remove case top (1.MP1) by sliding it straight up from case bottom (1.MP2).
3. Remove case handle assembly (1.MP3) from case bottom.

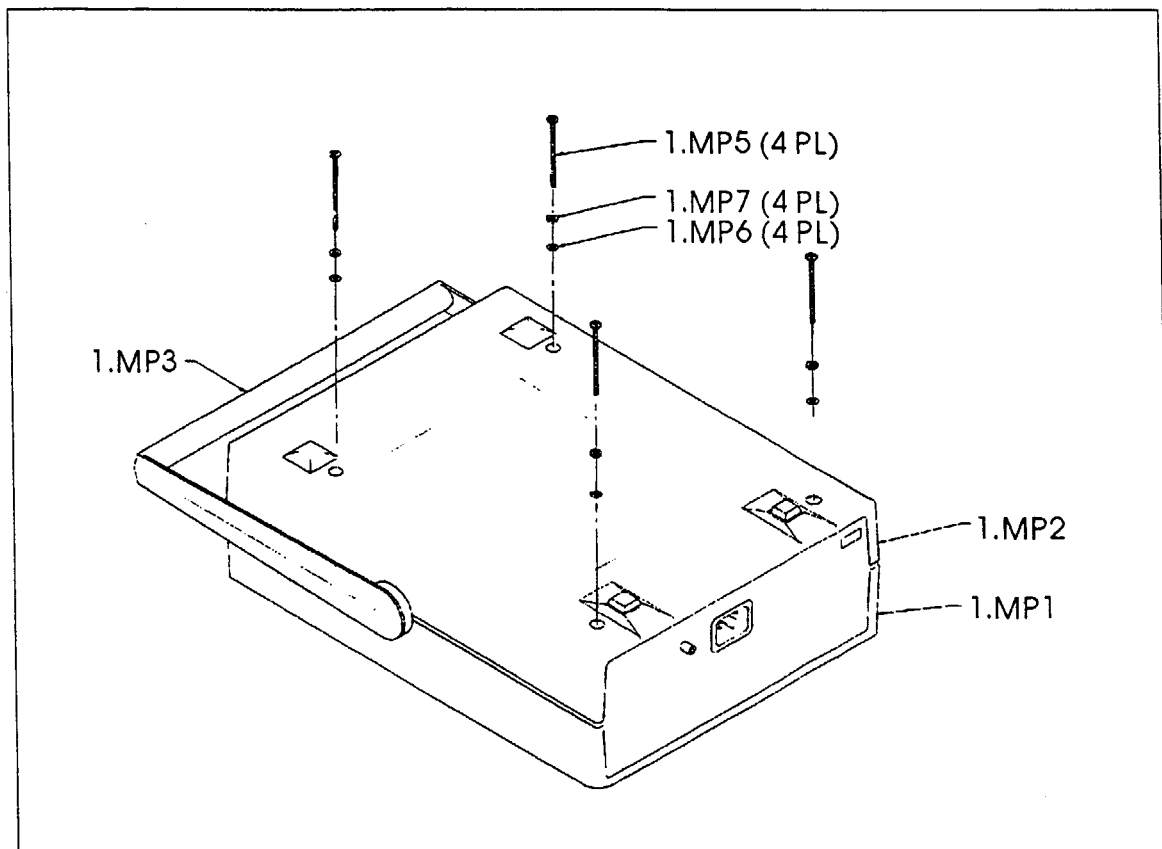

Figure 4-1. Case Screws Removal.

## CRT Assembly Removal:

Refer to Figure 4-2.

1. Remove two screws (1.MP8) on CRT yoke cap. Lift off CRT yoke cap (1.MP9).
2. Remove CRT stop (1.MP11) by withdrawing it toward the rear of the unit.
3. Grasp CRT assembly (1.A4) and carefully pull it out away from the Front Control assembly (1.A3). Lift CRT assembly out and lay it down gently alongside case bottom.
4. Disconnect the CRT cable assembly from the Main PCB assembly.
5. Remove CRT assembly.

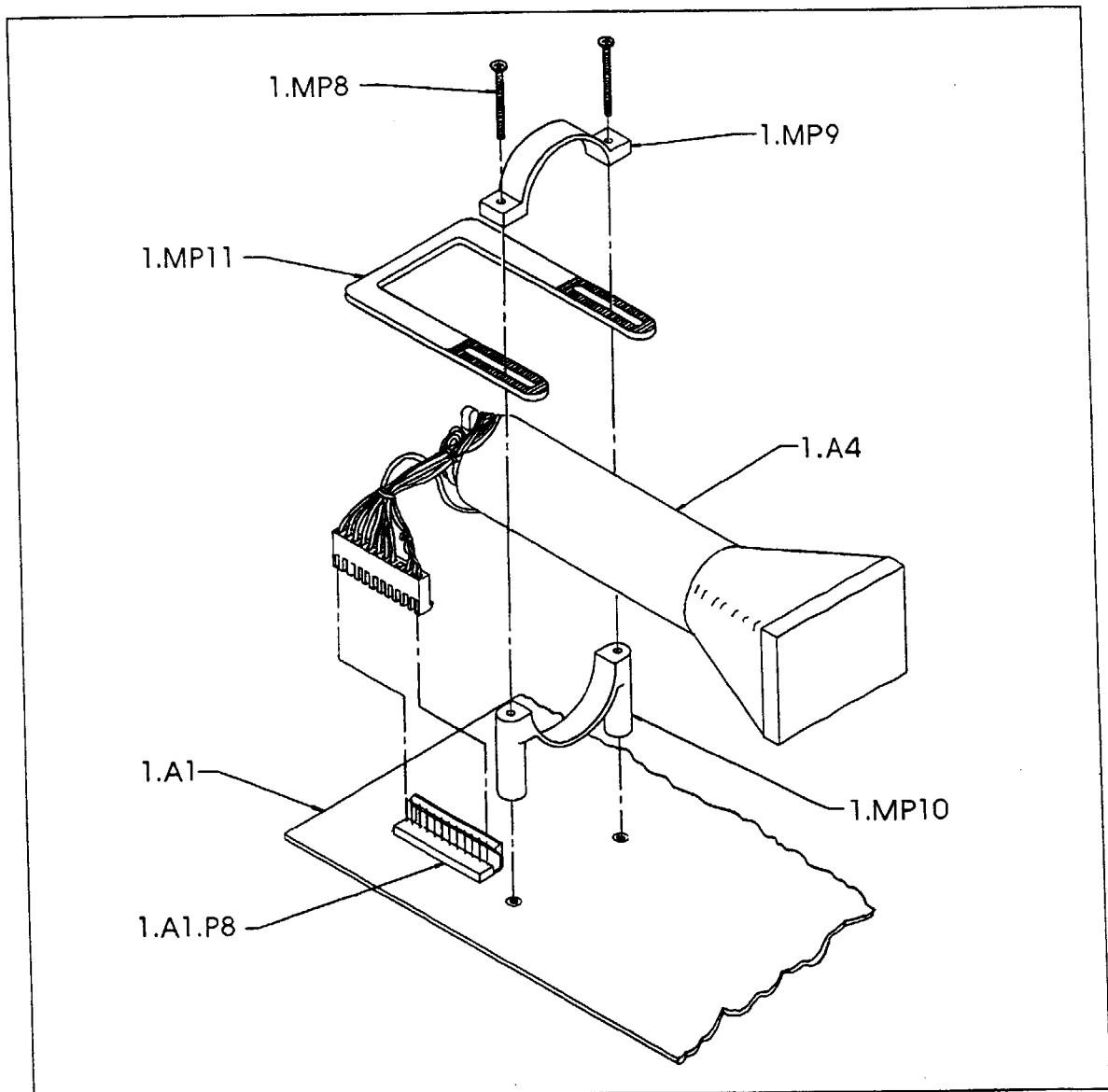

Figure 4-2. CRT Assembly Removal.

### Signal PCB Assembly Removal:

Refer to Figure 4-3.

1. Remove six screws (1.MP16) on Signal PCB assembly (1.A2).
2. Disconnect the three pin connector (1.A3.A2.J3) from the Signal PCB assembly.
3. Grasp the Signal PCB assembly and carefully pull it straight up and away from the Main PCB assembly (1.A1.)

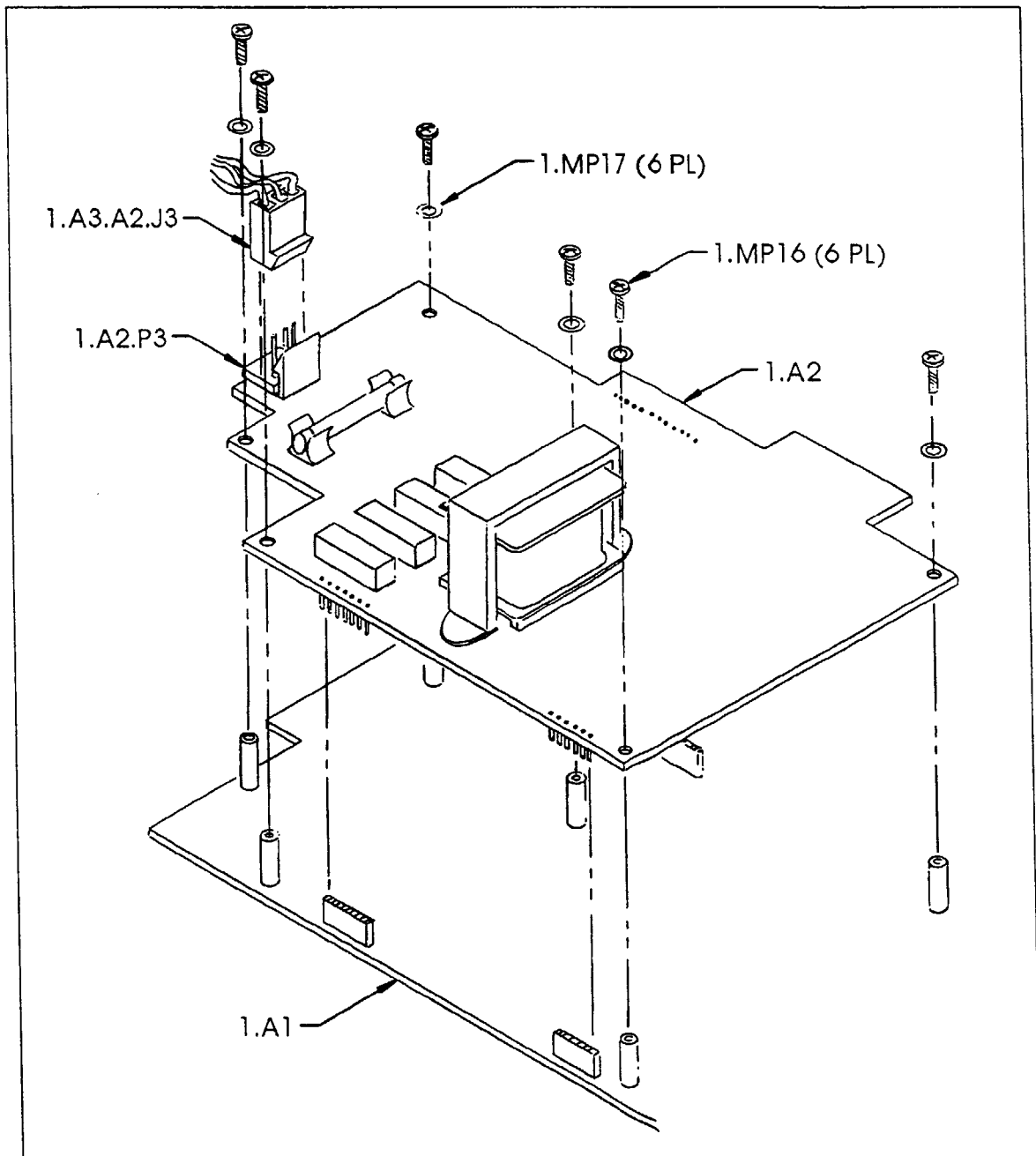

Figure 4-3. Signal PCB Assembly Removal.

**Power Transformer Removal:**

Refer to Figure 4-4.

1. Disconnect the Power transformer (1.T1) cable assembly from the Main PCB assembly (1.A1).
2. Remove two screws (1.MP14) on Power transformer assembly.
3. Remove Power transformer assembly (1.T1).

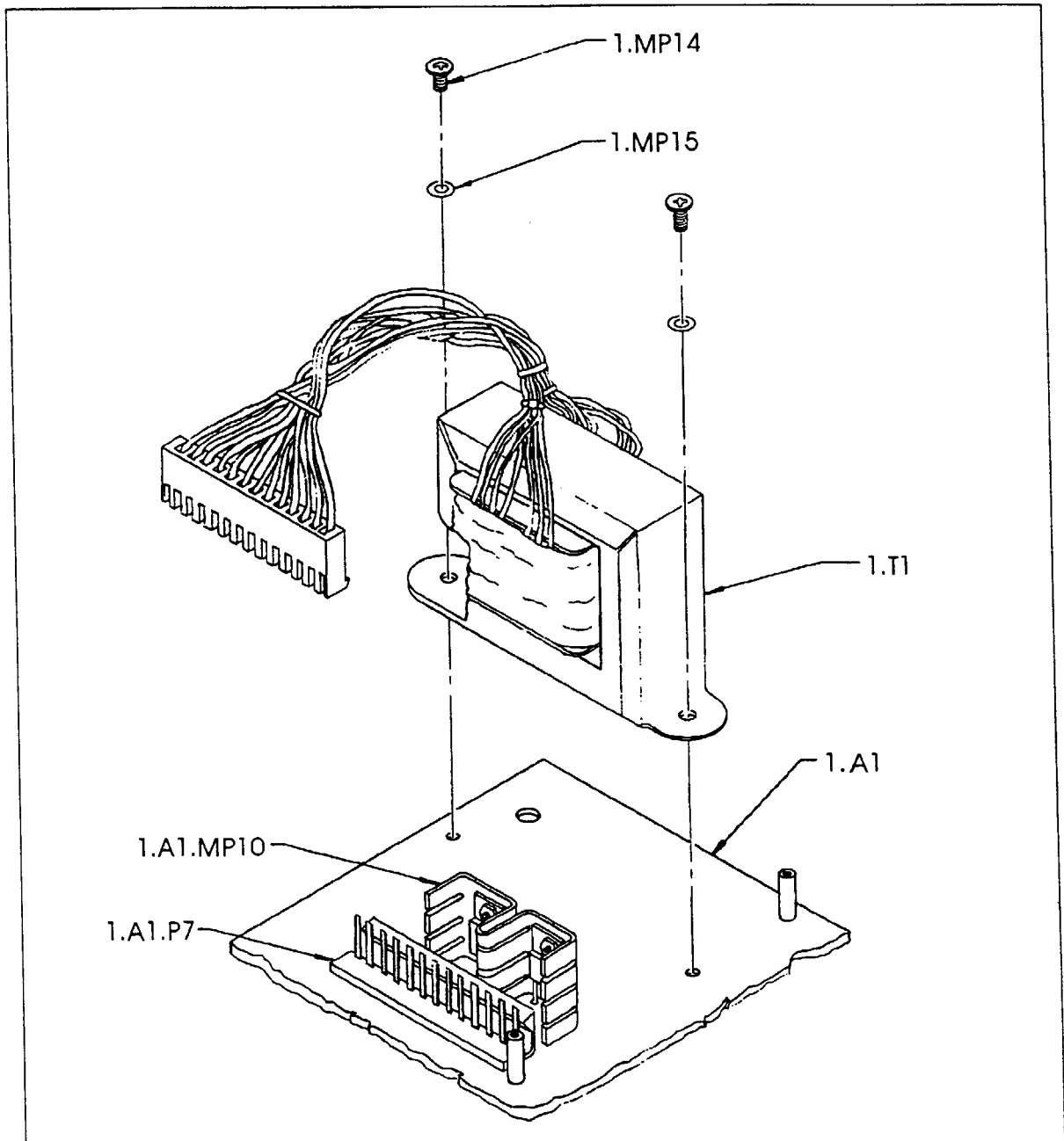

Figure 4-4. Power Transformer Removal.



### Main PCB Assembly Removal:

Refer to Figure 4-5.

1. Remove four case spacers (1.MP4) from Main PCB assembly.
2. Remove three screws (1.MP16) and washers (1.MP17) on Main PCB assembly.
3. Remove Main PCB assembly (1.A1) and Front Control assembly (1.A3) from case bottom (1.MP2) as follows:
  - a. Grasp both Main PCB assembly and Front Control assembly at the same time.
  - b. Remove both assemblies from case bottom at same time by lifting assemblies straight up and away from case.

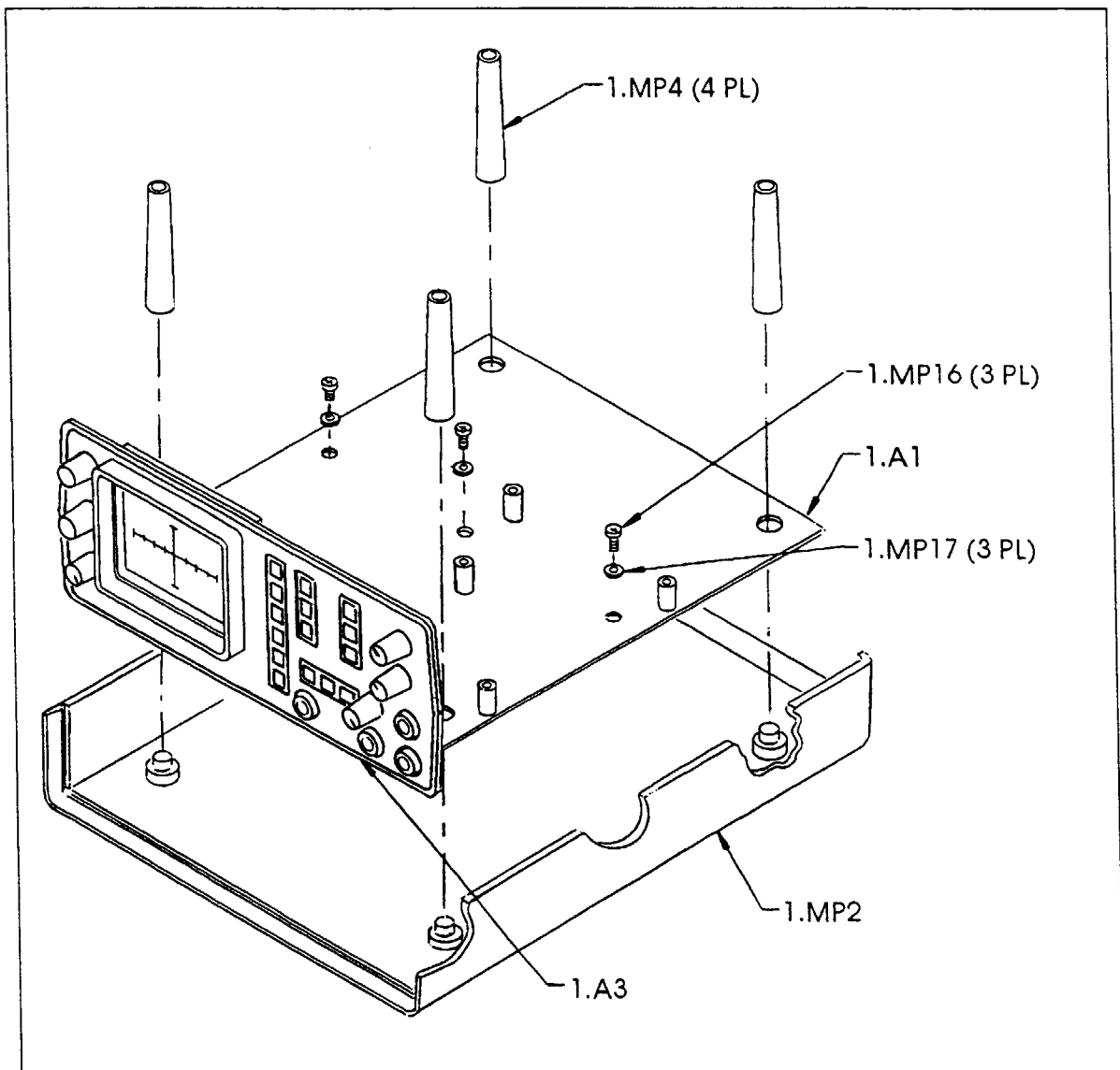

Figure 4-5. Main PCB Assembly Removal.

## Front Control Assembly Removal:

Refer to Figure 4-6.

1. Loosen set screw in shaft coupler (1.MP12) for Intensity control shaft (1.MP13).
2. Remove Intensity control shaft (1.MP13) with knob (1.MP18) by pulling it out through the Front Control assembly (1.A3).
3. Disconnect two pin connector (1.A3.A2.J5) from the Main PCB assembly (1.A1). See Figure 4-7.
4. Grasp the Front Control assembly (1.A3) and the Main PCB (1.A1) and carefully separate by pulling them straight apart.

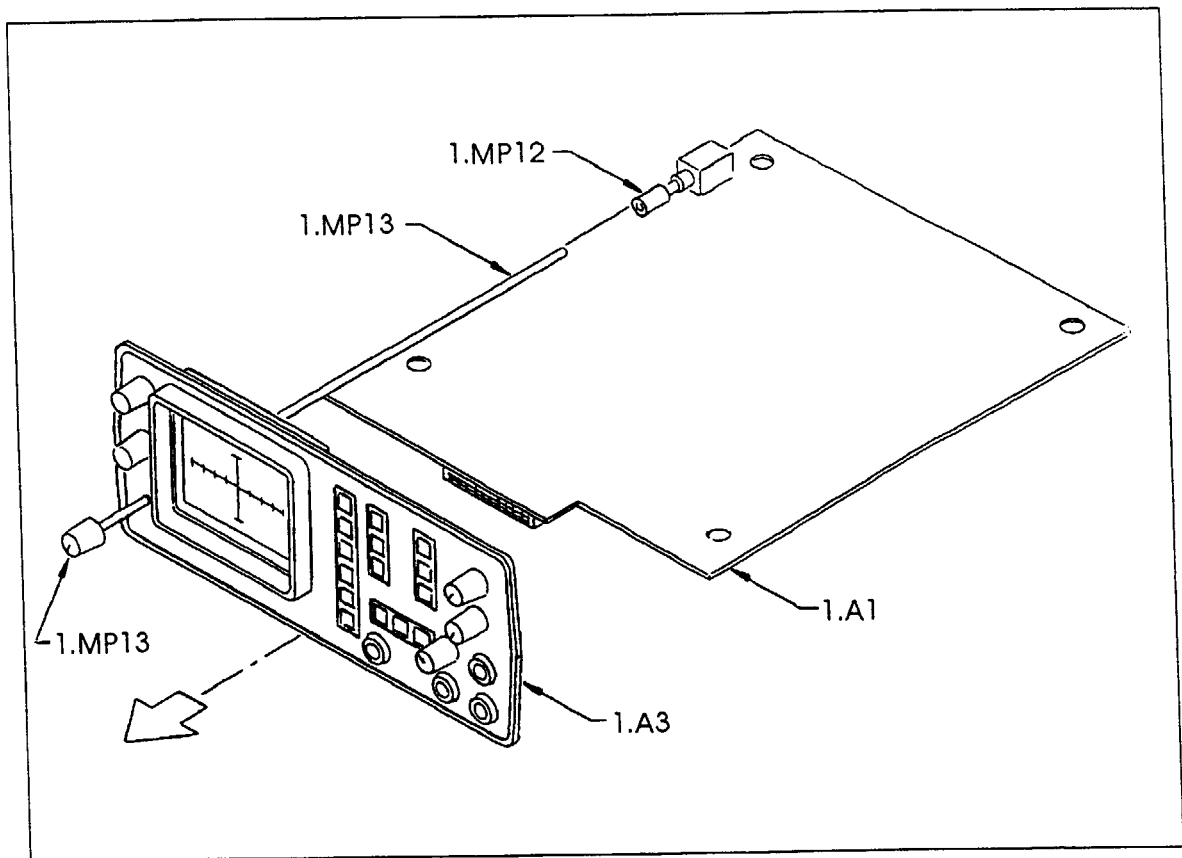

Figure 4-6. Front Control Assembly Removal.



## 4-5. REASSEMBLY PROCEDURE

Refer to Figures 4-1 through 4-7.

To reassemble the instrument, proceed as follows:

1. Reassemble the Front Control assembly by reversing the disassembly procedure.
  - a. Install Control PCB assembly on rear of face plate with eight screws (1.A3.MP3).
  - b. Mount and secure a black knob (1.MP18) to each of the five control shafts. Tighten knobs with proper tool. Turn all pots fully counterclockwise.
  - c. Place two blue (with line) end caps (1.MP22) on knobs labeled LEVEL and WIDTH. Make sure that the lines on each cap point to the lower left tick marks.
  - d. Place two black end caps (1. MP19) on knobs labeled HORZ and VERT.
  - e. Place a black (with line) end cap (1.MP21) on knob labeled RATE. Make sure the line on the cap points to the lower left tick mark.
2. Align 1.A3.A1.P6 socket on Front Control assembly (1.A3) to 1.A1.J6 connector on Main PCB assembly (1.A1) and carefully mate these connectors together.
3. Connect cable assembly (1.A3.A2.J5) to the Main PCB assembly.
4. Grasp Main PCB assembly (1. A1) and Front Control assembly (1.A3) together as a single assembly and install in case bottom (1.MP2). Make sure that Front Control assembly is set in case bottom guide correctly.
5. Secure Main PCB assembly to case bottom with three screws (1.MP16).
6. Insert Intensity control shaft (1.MP13) through Front Control assembly (1.A3) from the front of the unit and reconnect to shaft coupler (1.MP12). Position white line on cap toward POWER OFF and make sure Intensity control pot (1.A1.R45) is fully counterclockwise. Tighten screw on coupler.
7. Replace four case spacers (1.MP4) over the case bottom (1.MP2) posts that protrude through Main PCB assembly (1.A1).
8. Mount Power transformer (1.T1) on Main PCB assembly (1.A1) with two screws (1.MP14) and washers (1.MP15). Be sure to replace Ground wire under front screw.
9. Reconnect Power transformer cable assembly to Main PCB assembly.
10. Place CRT assembly (1.A4) and CRT yoke base (1.MP10) over Main PCB assembly. Make sure base is seated properly over mounting nuts and that the CRT assembly is installed with seam on CRT shield facing Main PCB assembly.
11. Push CRT assembly (1.A4) forward into the Front Control assembly bezel until the CRT is seated as close to the graticule as practical. Make sure that the CRT assembly is seated properly against the foam strips on the Front Control assembly bezel.

## MAINTENANCE

12. Insert CRT stop (1.MP11) from rear of unit and place on CRT yoke base (1.MP10). Make sure that the CRT cable assembly is free of the CRT stop and that the stop is pushed forward as far as it will go.
13. Place CRT yoke cap (1.MP9) over CRT yoke base (1.MP10), CRT stop (1.MP11) and CRT assembly. Drop screws (1.MP8) through cap (1.MP9) to base (1.MP10). While pushing the CRT assembly gently but firmly against the Front Control assembly, tighten two screws (1.MP8) on CRT yoke cap (1.MP9). Check to make sure that the CRT assembly is properly and securely assembled in place.
14. Align the connectors of the Signal PCB assembly (1.A2.P1, 1.A2.P2, 1.A2.P3) with those of the Main PCB assembly (1.A1.J1, 1.A1.J2, 1.A1.J3). Push the Signal PCB assembly straight down until it seats against the standoffs on the Main PCB assembly.
15. Secure Signal PCB assembly to Main PCB assembly with six screws (1.MP16) and washers (1.MP17).
16. Connect the three pin connector (1.A3.A2.J3) to Signal PCB assembly.
17. Install case handle (1.MP3) into case bottom (1.MP2).
18. Place case top (1.MP1) over case bottom (1.MP2). Make sure that the Front Control assembly (1.A3) tracks into the case top guides and that the rear of the case top slides in the guides in the case bottom.
19. Grasp both case top and bottom together. Turn unit over and install four screws (1.MP5) in case bottom (1.MP2).

## 4-6. PERFORMANCE TESTS

The following procedures allow you to compare the performance of your instrument with the specifications listed in Section 1. They can be used for incoming inspection, and periodic verification of specifications. A one year cycle is recommended for verification of specifications. If the instrument fails any test, internal adjustment and/or repair is needed. You do not have to disassemble the instrument to perform the tests. Throughout these procedures, the 2000 being tested is referred to as the UUT (Unit Under Test).

### Logic Section:

1. The UUT should come on in channel A, low range, 50/60 Hz, and DC mode.
2. Press 400 Hz, 2000 Hz, and 50/60 Hz. The corresponding LED should illuminate when the button is pressed and should stay on until another frequency button is pressed.
3. Press the ALT button. The ALT LED should illuminate and the channel A and channel B LEDs should be alternately on. Verify that the alternation rate increases with clockwise rotation of the Rate control. Then press the channel A button. The ALT LED should go off and the channel A LED should stay on. Press the ALT button again and then press the channel B button to make sure it also cancels the Alternate function.
4. Press the AUTO button. The AUTO LED should illuminate and the UUT should scan through the ranges as follows: low, medium 1, medium 2, high, back to low, and repeat. Verify that the scanning rate increases with clockwise rotation of the Rate control. Then press the low button. This should cancel the Auto function and set the UUT to the low range. Repeat this procedure for the other three ranges (i.e., select Auto, then a range).
5. The UUT should be in the high range. Press the HIGH LOCKOUT button. This should illuminate the HIGH LOCKOUT LED and set the UUT to the medium 2 range. Then press the AUTO button. The UUT should scan through the low, medium 1, and medium 2 ranges, and bypass the high range. Press the HIGH LOCKOUT button again. The HIGH LOCKOUT LED should go out and the UUT should go back to scanning all four ranges.
6. The UUT should be in Auto. Press the ALT button. This will put the UUT in the Auto/Alternate mode. For the Auto/Alternate sequence, see Figure 3-2. Varying the Rate control should increase the scan/alternate rate with clockwise rotation.
7. The UUT should have the Pulse/DC LED continuously on. Press the positive ( + ) button several times. The positive LED should toggle between on and off each time the button is pressed. With positive off, repeat the above procedure with the negative ( - ) button. The negative LED should toggle on and off like the positive LED. Next turn positive on and negative off. The Pulse/DC LED should be on which indicates DC mode. Pressing the Pulse/DC button should activate pulse mode which is indicated by a flashing Pulse/DC LED. Now turn negative on so the top two LEDs are on and the Pulse/DC LED is flashing. Press the Pulse/DC button again and the LED should again be continuously on. Also the negative LED should go out (all three LEDs continuously on is a not-allowed state). Finally, press the positive button several times. With each press, the positive LED should go out and the negative LED come on, or visa versa.

**Signal Section:**

1. Select 50/60 Hz, channel A, and High Lockout = off on the front panel. Adjust the CRT controls (Intensity and Focus) for a sharp trace on the CRT display.
2. Measure the sine wave voltage between the channel A and common test terminals using an oscilloscope or a digital multimeter. Verify the presence of the following voltages on the test terminals in each range. For this test, make sure that the input impedance of your scope or DMM is at least 10 MΩ. Tolerance is ± 5%.

Range	V <sub>p</sub>	V <sub>rms</sub>
High	60	42.43
Medium 2	20	14.14
Medium 1	15	10.61
Low	10	7.07

3. Measure the short circuit current in each range. Connect your DMM to the channel A and common test terminals and set to ACmA. Tolerance is ± 10%. Verify the following current readings:

Range	mA <sub>rms</sub>
High	0.57
Medium 2	0.53
Medium 1	8.5
Low	132

4. Use a scope or frequency counter to measure the test signal frequencies. When a 50 Hz or 60 Hz power line is used the 50/60 Hz test signal frequency should be locked to the line frequency. To verify this, check the 50/60 Hz test signal using a scope with the trigger set to LINE. If the test signal is stationary, then the signal is locked to the line. If a 400 Hz power line is used the 50/60 Hz test signal frequency should be 80 Hz and will not be locked to the line. Verify the following test signal frequencies:

Frequency Select	Power Line Frequency (Hz)		
	50 Hz	60 Hz	400 Hz
50/60	50	60	80
400	400	400	400
2000	2000	2000	2000

5. Remove the DMM, scope, and/or frequency counter. Turn the Rate control fully clockwise, select Auto and verify that there is only slight movement in the open circuit horizontal traces. Then short the channel A and common test terminals together and verify that there is only slight movement in the short circuit vertical traces.

**Pulse Generator:**

1. Connect Ch.1 of a dual trace scope to G1 (pulse generator terminal), Ch.2 to the channel A test terminal, and scope ground to the common test terminal. Set the scope trigger to Ch.2. Select 50/60 Hz and channel A.
2. Select DC mode. Turn positive on and verify that the Level control adjusts the DC level at G1 from zero to +5VDC ( $\pm 10\%$ ). Turn positive off, negative on, and verify that the Level control varies the DC level from zero to -5VDC ( $\pm 10\%$ ). Turn both positive and negative off and verify that the output is zero for all positions of the Level control. Select pulse mode and repeat the last step.
3. Vary the Width control and compare the scope display to Figure 3-6 for each of the three pulse polarity types. The rising edge of a positive pulse should always coincide with each positive-going zero crossing of the test signal with positive pulses or composite pulses selected. The falling edge of a negative pulse should always start at each negative-going zero crossing of the test signal with negative pulses or composite pulses selected. Repeat this step for 400 Hz and 2000 Hz. Slope in the rising and falling edges of the pulses is acceptable at 2000 Hz.



## 4-7. INTERNAL ADJUSTMENTS

In normal operation periodic readjustment of your 2000 is not necessary. However, if your 2000 has been repaired or if it has failed any of the performance tests, it is necessary to perform these internal adjustments. To gain access to internal adjustments, first remove the four case screws, then lift off the case top. See Figure 4-1. In the following procedure, the 2000 that is being adjusted is referred to as the UUT (Unit Under Test).

### Power Supply Section:

The High Voltage is factory adjusted to  $-1320$  VDC, and users are advised not to readjust trimpot 1.A1.R34 unless it is absolutely necessary. This adjustment requires a digital multimeter (DMM) and a High Voltage probe. 1.A1.R34 (High Voltage) is on the Main PCB. Refer to Figure 4-8 for adjustment location and Figure 6-2 for schematic.

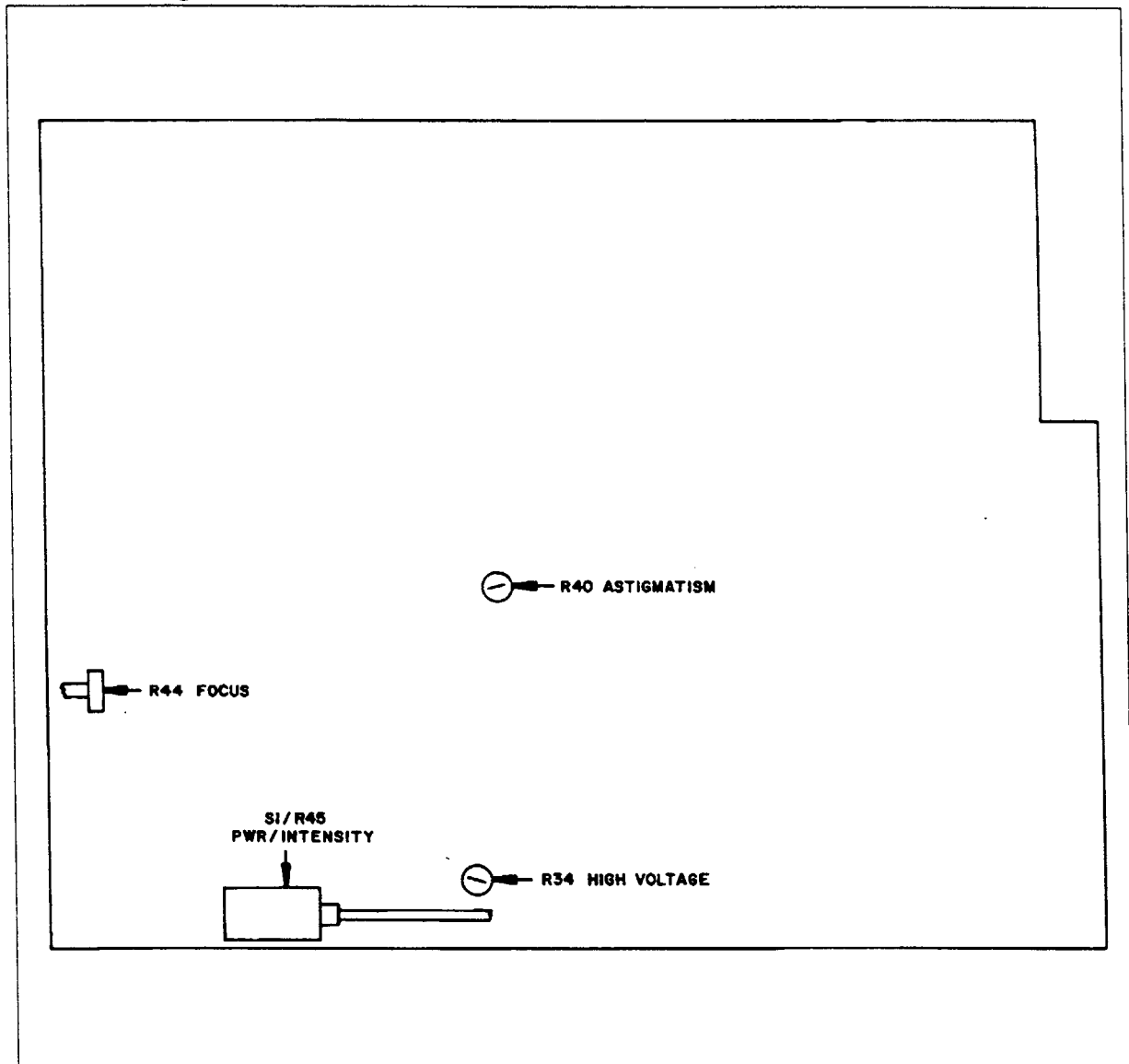

Figure 4-8. Main PCB Adjustment Locations.

**WARNING**  
**Hazardous high voltage.**

**Procedure:**

1. Connect the common lead of the High Voltage probe to common (e.g., heatsink of 1.A1.U12/1.A1.U13).
2. Connect the High Voltage probe to 1.A1.P8-pin 6 on the Main PCB.
3. Turn power on.
4. Adjust 1.A1. R34 until the DMM reads -1320 VDC.

**CRT Section:**

1.A1. R40 (Astigmatism) is on the Main PCB. Refer to Figure 4-8 for adjustment location and Figure 6-2 for schematic.

**Procedure:**

1. Adjust the Intensity control to a comfortable level for normal viewing.
2. Turn the Focus control fully clockwise (viewed from the back).
3. Adjust 1.A1. R40 until the unfocused dots on each end of the trace are circular.
4. Readjust the Focus control for the narrowest possible trace.

## Oscillator Section

All adjustments and test points in this section are located on the Signal PCB assembly. Refer to Figure 4-9 for adjustment locations and to Figure 6-4 for schematic.

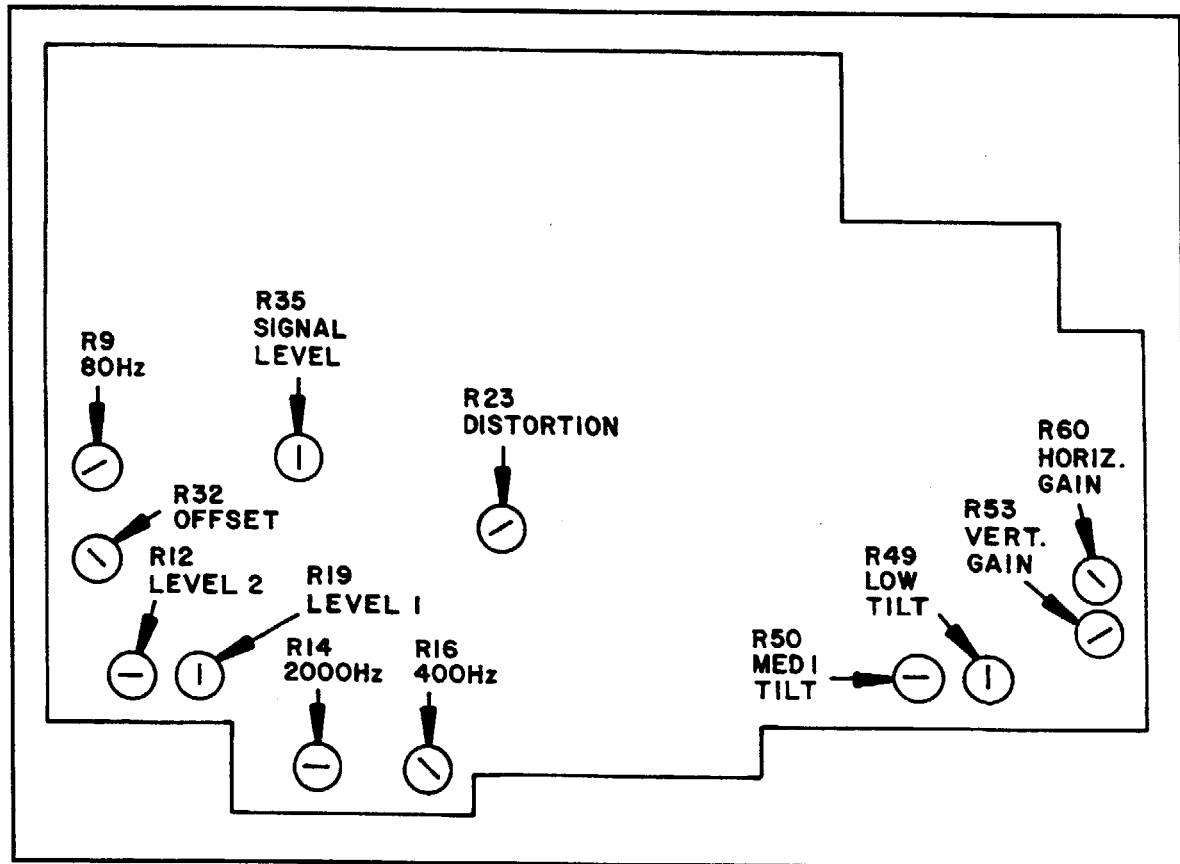

Figure 4-9. Signal PCB Adjustment Locations.

### Procedure:

1. Select 400 Hz, turn 1.A2.R23 (Distortion) fully CCW, and connect a scope to TP6.
2. TP6 should be a 380 mV<sub>pp</sub> triangle wave. If not, adjust 1.A2.R19 (Level 1) for a 380mV<sub>pp</sub> triangle wave.
3. Check TP9 with the scope. It should be a sine wave with small points on each peak. If the points are not equal on the positive and negative peaks, or the waveform is not symmetric, adjust 1.A2.R32 (Offset) for best symmetry. Then adjust 1.A2.R23 until the small points on the sine wave disappear leaving a low distortion sine wave. The sine wave should have an amplitude of approximately 560 mV<sub>pp</sub>.
4. Connect a frequency counter to TP9. If it is not 400 Hz, then adjust 1.A2.R16 (400 Hz) until the counter reads 400 Hz  $\pm$  1 Hz. Then select 2000 Hz and adjust 1.A2.R14 (2000 Hz) if necessary until the counter reads 2000 Hz  $\pm$  1 Hz. Select 50/60 Hz. Verify that the counter reads the same frequency as the power line in use. This should also be checked by switching to LINE trigger on the scope. The output waveform should be stationary which indicates that it is

synchronized with the power line. Adjust 1.A2.R12 (Level 2) until the amplitude at TP9 does not change as the different frequencies are selected.

- When 50/60 Hz is selected, and a 400 Hz powerline is in use, 1.A2.R9 (80 Hz) is factory-adjusted to produce an output frequency of 80 Hz  $\pm$  1 Hz. If not, adjust 1.A2.R9 until the counter reads 80 Hz. Disconnect the scope and/or frequency counter from the UUT.

**Signal Section:**

All adjustments and test points in this section are located on the Signal PCB assembly. Refer to Figure 4-9 for adjustment locations and to Figure 6-4 for schematic.

**Procedure:**

- Select the low range, 50/60 Hz, channel A, and High Lockout = off on the front panel.
- Measure the sine wave voltage between the channel A and common test terminals using a digital multimeter. Adjust 1.A2.R35 (Signal Level) to give 7.07 V<sub>rms</sub>  $\pm$  1% .
- Verify the presence of the following voltages on the test terminals in each range. For this test, make sure that the input impedance of your scope or DMM is at least 10 M $\Omega$ . Tolerance is  $\pm$  5% .

Range	V <sub>p</sub>	V <sub>rms</sub>
Medium 1	15	10.61
Medium 2	20	14.14
High	60	42.43

- Short the channel A test terminal to the common test terminal and adjust the Trace Rotate control on the front panel (1.A3.A1.R3) until the CRT trace is lined up with the vertical axis of the CRT graticule.
- Adjust 1.A2.R53 (Vertical Gain) until the endpoints of the trace match the endpoints of the graticule. Select Auto and verify that the trace length is the same in each range and that each trace is parallel to the vertical axis.
- Select the low range again. This cancels the Auto function. Remove the short between channel A and common.
- Adjust 1.A2.R49 (Low Horizontal Tilt) until the trace is parallel to the horizontal axis.
- Adjust 1.A2.R60 (Horizontal Gain) until the endpoints of the trace match the endpoints of the graticule.
- Select the medium 1 range. Adjust 1.A2.R50 (Medium 1 Horizontal Tilt) until the trace is parallel to the horizontal axis.
- Select Auto and verify that the trace length is the same in each range and that each trace is parallel to the horizontal axis. Verify that this requirement is satisfied at 400 Hz and 2000 Hz also.

## 4-8. TROUBLESHOOTING

### CAUTION

Static discharge can damage CMOS components. Follow the handling precautions for static-sensitive devices previously described in this section. Never remove, install, or otherwise connect or disconnect components without first turning the instrument power off.

If necessary, refer to Section 2 for operating instructions or Section 3 for the theory of operation. The troubleshooting information is supported by the schematics in Section 6.

This section assumes that the user has done the performance tests in section 4-6 and noted any discrepancies in performance. Further, it is also assumed that the user has completed or attempted to complete the internal adjustments in section 4-7 and noted any problems found.

The troubleshooting guides that follow refer to the location of possible defective components by assembly number:

- |                            |                               |
|----------------------------|-------------------------------|
| 1.A1 - Main PCB Assembly   | 1.A3 - Front Control Assembly |
| 1.A2 - Signal PCB Assembly | 1.A4 - CRT Assembly           |

These are the same assembly numbers that are used in the list of replaceable parts in Section 5. The components referred to in the guides are usually the major ones within a section of the circuit. Other miscellaneous components (e.g., diodes, resistors, and capacitors) connected to the indicated parts should also be checked for possible failure. The following outline should be followed sequentially until all faults are corrected:

1. Check and verify the power supply voltages listed in Table 4-1. If any voltage is out of tolerance, use the power supply troubleshooting guide (Table 4-2).
2. Using the performance test discrepancies from section 4-6, go through the performance test troubleshooting guide in Table 4-3.
3. If indicated in Table 4-3, the following horizontal/vertical tests should be performed:

With an open circuit on the test terminals, check the horizontal output at 1.A2.P4-pin 9 (connector P4, pin 9) with a scope. The signal at this point should be an undistorted sine wave with the same amplitude in all ranges at a particular frequency. The amplitude should be approximately 0.6V<sub>p</sub>. The amplitude may change slightly when the test signal frequency is changed, but it should not change noticeably from range to range.

Now short the test terminals. The signal at 1.A2.P4-pin 9 should go to zero in all ranges.

With the short circuit still on the test terminals, check the vertical output at 1.A2.P4-pin 10 with the scope. Again, this signal should have equal amplitude regardless of range and change only slightly with different frequencies. The amplitude should be approximately 0.25V<sub>p</sub>.

Now open the test terminals. The signal at 1.A2.P4-pin 10 should go to a small value less than 10mV<sub>p</sub> in amplitude.

If these tests check out properly, then any problem with the display is related to the CRT circuits.

4. Using the suggestions from Table 4-3 and the preceding tests (if applicable), follow the additional troubleshooting guide (Table 4-4).

In addition, Figures 4-10 through 4-23 show oscilloscope waveforms which are useful for troubleshooting the 2000.

**Table 4-1**  
**Power Supply Limits**

LOCATION	SUPPLY	MINIMUM	MAXIMUM
1.A2.P4 - Pin 6	+ 5 V	+4.5V	+5.5 V
1.A2.P4 - Pin 4	-5V	-4.5V	-5.5V
1.A2.P1 - Pin 2	+12V	+11V	+18 V
1.A2.P1 - Pin 5	-12V	-11V	-18V
1.A1.TP2	+180V	+170V	+200 V
1.A1.P8 - Pin 6	-1320V	-1310V	-1330V

**Table 4-2**  
**Power Supply Troubleshooting Guide**

VOLTAGE OUT OF TOLERANCE	POSSIBLE CAUSE/SUGGESTIONS
All are zero with power on	1.A1: F1 (line fuse)
+ 5V (+ 12V input is OK)	1.A1: U12
-5V (-12V input is OK)	1.A1: U13
+ 12V	1.A1: C12, D9, D10, T1
-12V	1.A1: C24, D7, D8, T1
+ 180V	1.A1: C22, D3, D4, D5, D6, T1
-1320V	1.A1: D1, D2, Q3, R28, T1, U11

**Table 4-3**  
**Performance Test Troubleshooting Guide**

TEST AND SYMPTOM	POSSIBLE CAUSE/SUGGESTION
<b>Logic Section</b>	
1. The UUT does not have proper initial conditions and steps 2 through 7 of the logic section performance test are correct.	1.A1: U4
2. The frequency buttons or LEDs do not function properly.	1.A1: U15, U18, U22, U24, U26 1.A3: S7, S8, S9, D7, D8, D9
3. The channel control buttons or LEDs do not function properly.	1.A1: U9, U17, U18, U19, U22, U24, Q12 1.A3: S13, S14, S15, D13, D14, D15, R8
4. The AUTO or range selection buttons or LEDs do not function properly.	1.A1: U18, U19, U20, U21, U22, U23, U24, U25, U26, Q14, Q15, Q16, Q17 1.A3: S2, S3, S4, S5, S6, D2, D3, D4, D5, D6, R8
5. The HIGH LOCKOUT button or LED does not function properly.	1.A1: U16, U18, U19, U20, U21 1.A3: S1, D1
6. The AUTO/ALT mode does not function properly.	Check steps 3 and/or 4 above.
7. The pulse generator buttons or LEDs do not function properly.	1.A1: U2, U7, U14, U15, U16, U17 1.A3: S10, S11, S12, D10, D11, D12
<b>Signal Section</b>	
2. All ranges produce zero voltage and current and the CRT display always shows short circuit signatures.	1.A2: F1 (signal fuse)
3. Proper voltages and/or currents are not produced in all ranges.	1.A2: U7, U8, T1, K1, K2, K3, K4 Check oscillator (Table 4-4)
4. Incorrect frequencies are produced.	1.A2: Check oscillator (Table 4-4)
5. Test 2, 3, and 4 above are correct but the CRT does not display the proper signatures.	1.A2: Perform the horizontal/vertical tests (step 3, section 4-8) to determine the location of the problem.
<b>Pulse Generator</b>	
2. The pulse generator does not function properly.	1.A1: U1, U2, U3, U4, U5, U6, U7, U8, U9, U10 1.A3: R5, R6, R7

**Table 4-4  
Additional Troubleshooting Guide**

SYMPTOM	POSSIBLE CAUSE/SUGGESTIONS
<p><b>Oscillator</b></p> <p>50/60 Hz does not function properly (400 Hz and 2000 Hz are OK).</p> <p>400 Hz and 2000 Hz do not function properly (50/60 Hz is OK).</p> <p>No frequency functions properly.</p> <p><b>Horizontal/Vertical</b></p> <p>The horizontal output does not function properly.</p> <p>The vertical output does not function properly.</p> <p><b>CRT</b></p> <p>Trace rotate does not function properly.</p> <p>Display does not function properly (horizontal and vertical outputs are OK).</p>	<p>1.A2: U1, U2, U3, U5</p> <p>1.A2: U4, U5</p> <p>1.A2: U5, U6, Q1, Q2</p> <p>1.A2: U9, U12, U13</p> <p>1.A2: U5, U9, U10, U11</p> <p>1.A1: Q4, Q5, U11 1.A4: L1 1.A3: R3</p> <p>1.A1: Q6, Q7, Q8, Q9, Q10, Q11 1.A3: R1, R2 1.A4</p>



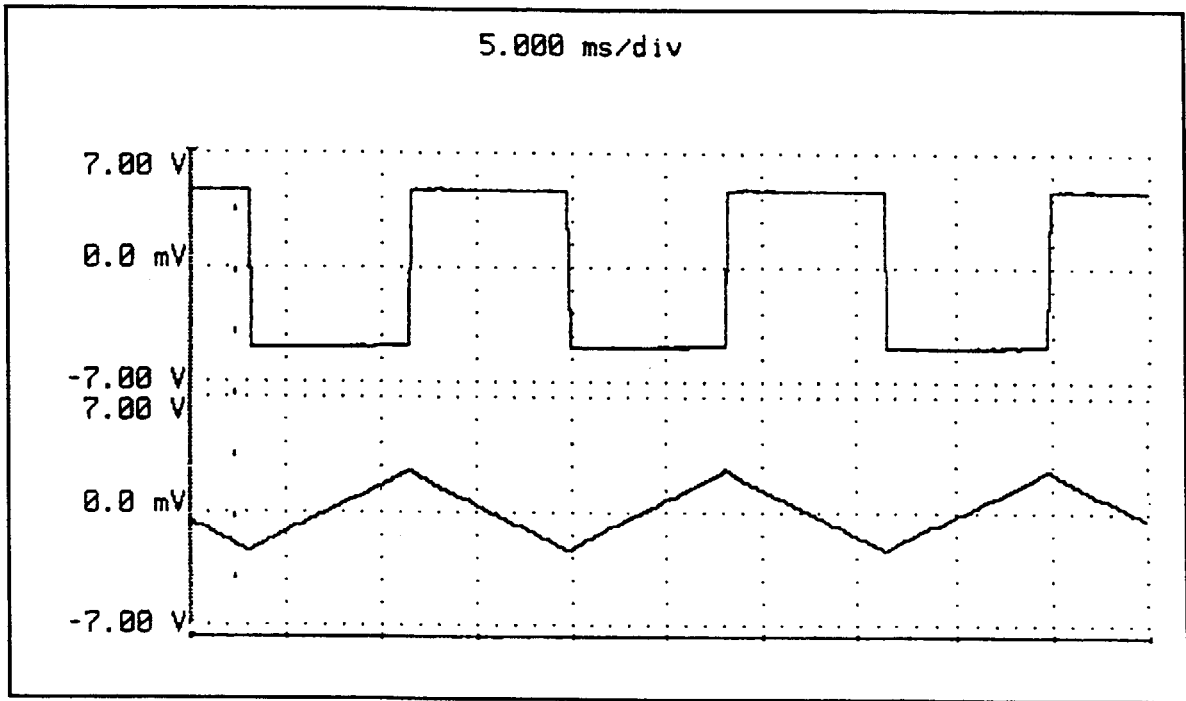

Figure 4-10. Signal PCB Waveforms: TP1 & TP4 - Settings: n.a.

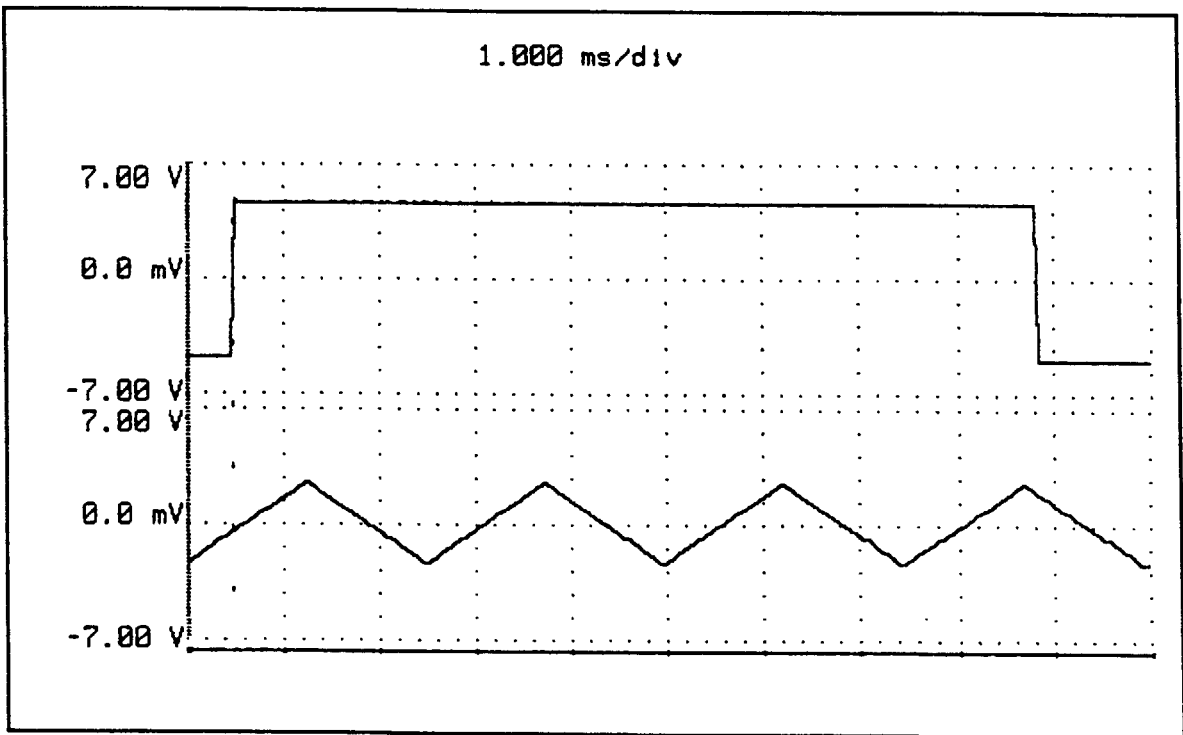

Figure 4-11. Signal PCB Waveforms: TP1 & TP5 - Settings: 400 Hz.

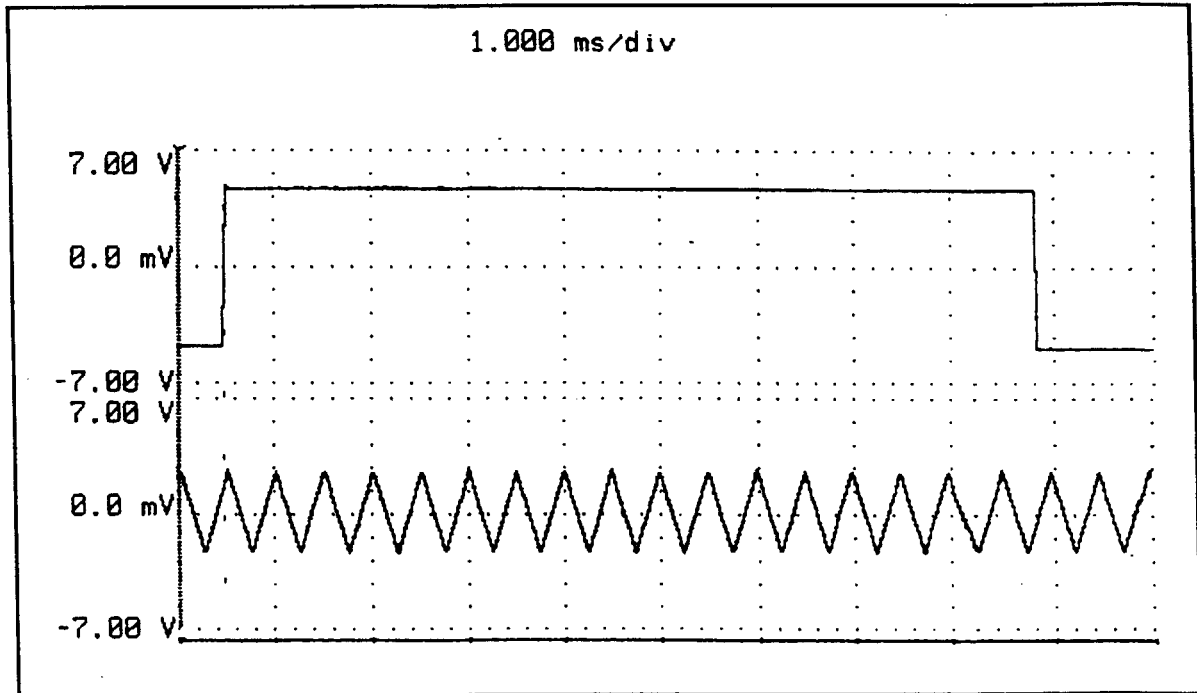

Figure 4-12. Signal PCB Waveforms: TP1 & TP5 - Settings: 2000 Hz.

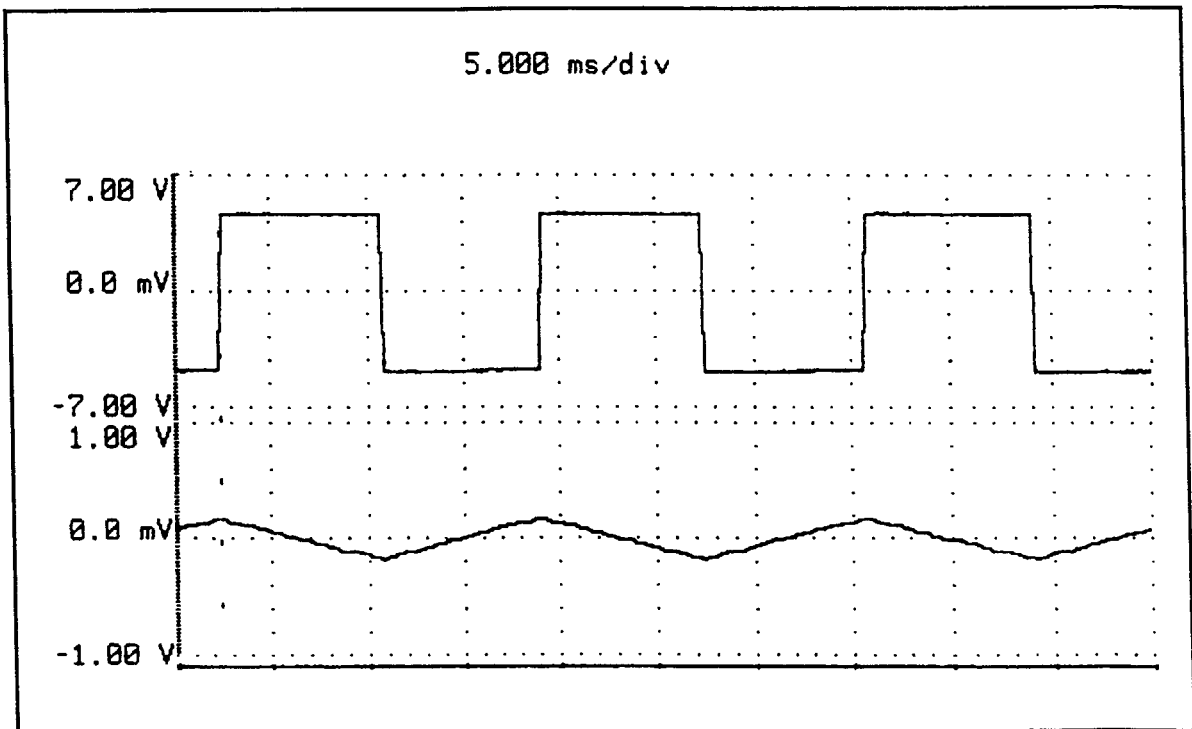

Figure 4-13. Signal PCB Waveforms: TP1 & TP6 - Settings: 50/60 Hz.

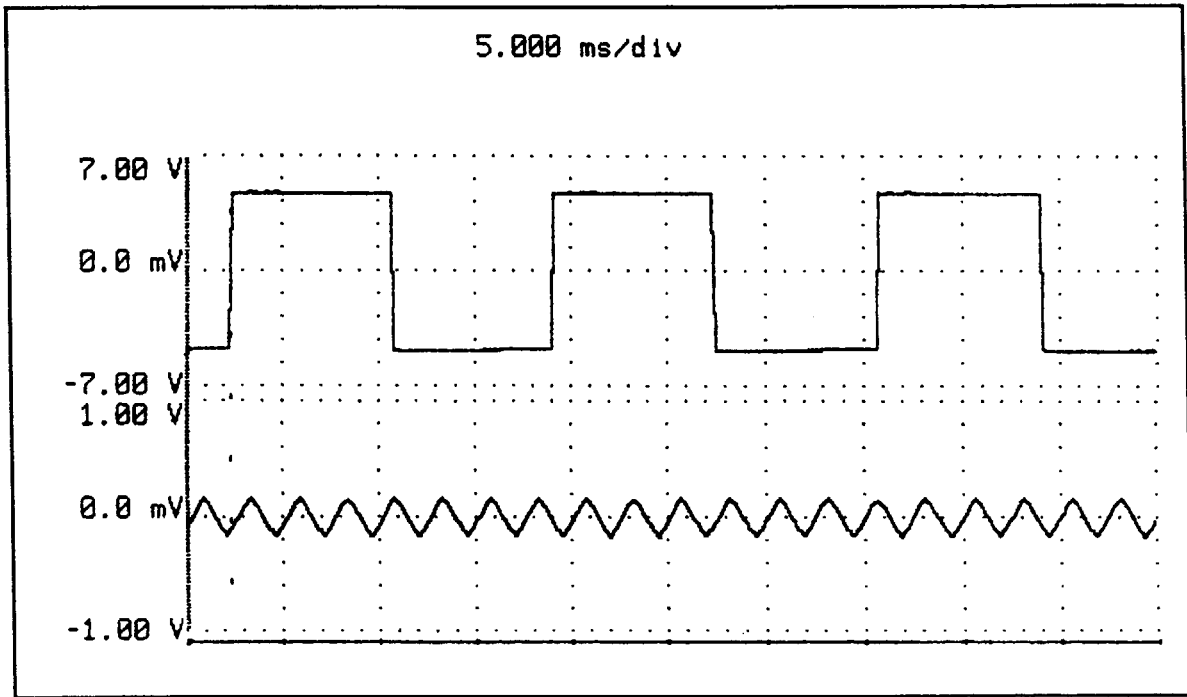

Figure 4-14. Signal PCB Waveforms: TP1 & TP6 - Settings: 400 Hz.

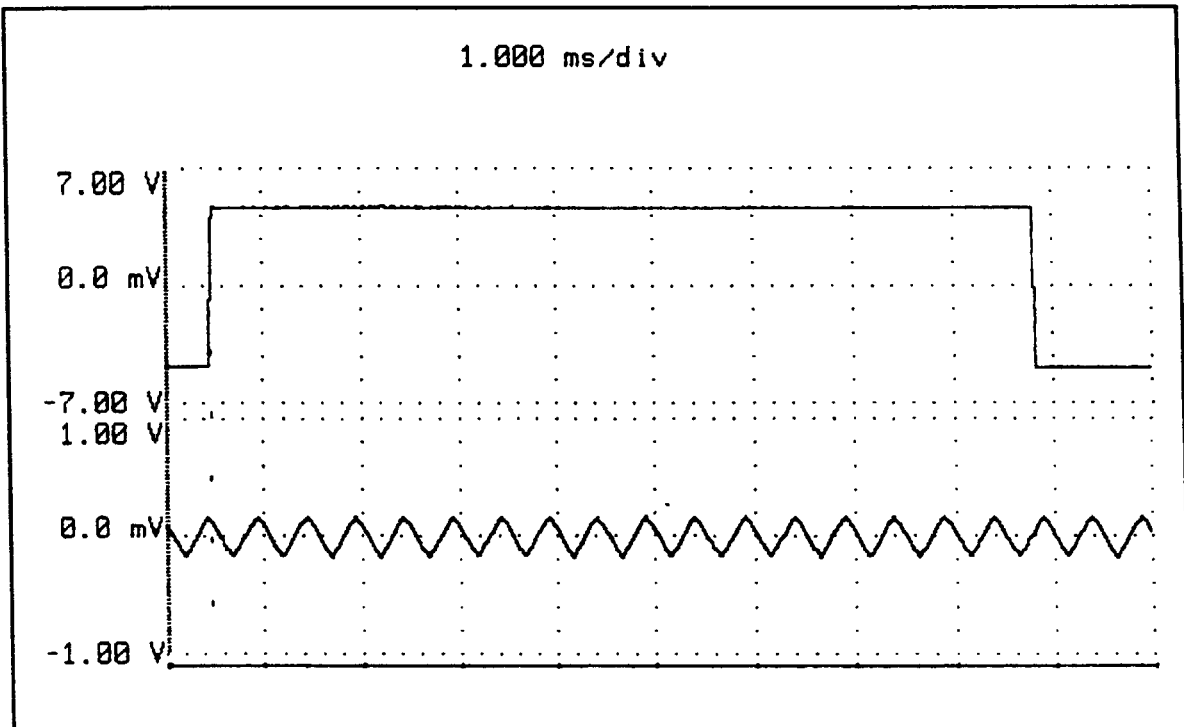

Figure 4-15. Signal PCB Waveforms: TP1 & TP6 - Settings: 2000 Hz.

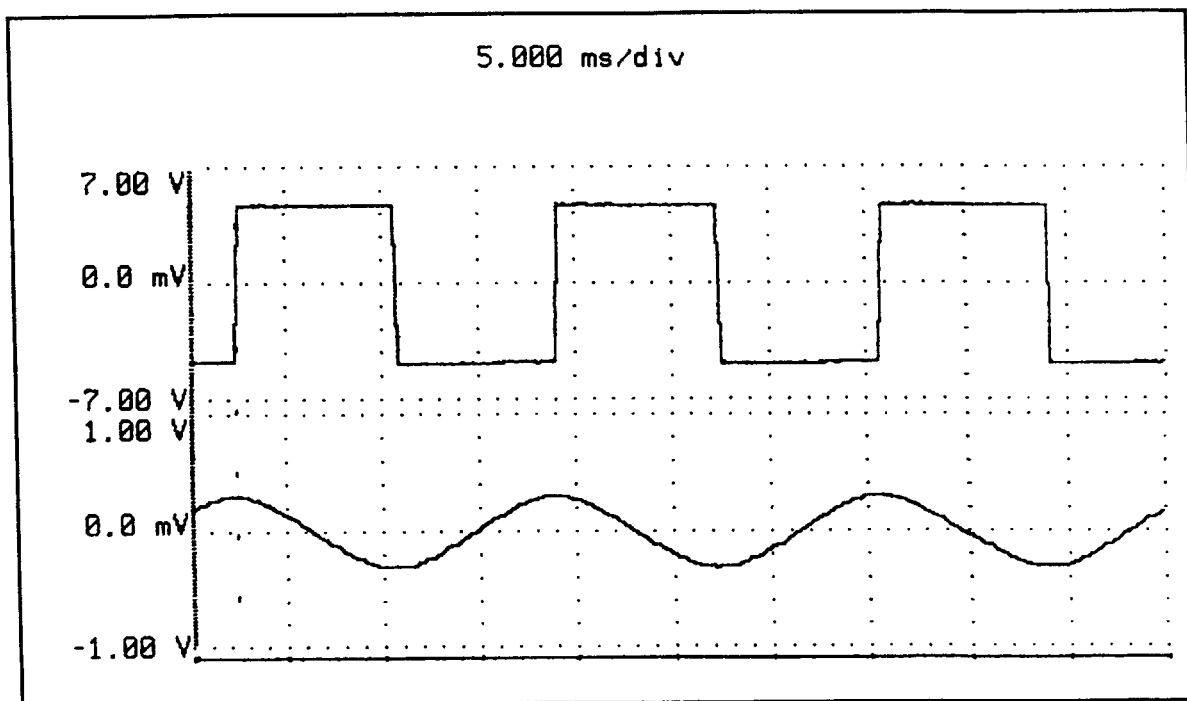

Figure 4-16. Signal PCB Waveforms: TP1 & TP9 - Settings: 50/60 Hz.

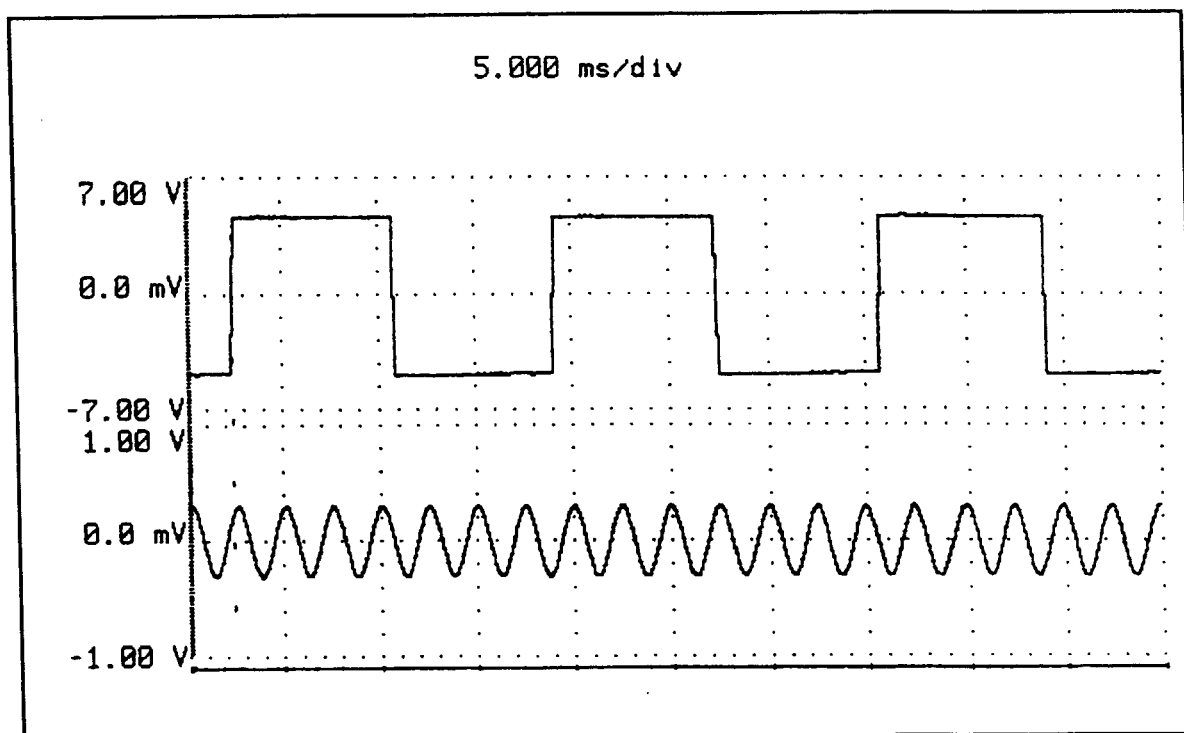

Figure 4-17. Signal PCB Waveforms: TP1 & TP9 - Settings: 400 Hz.

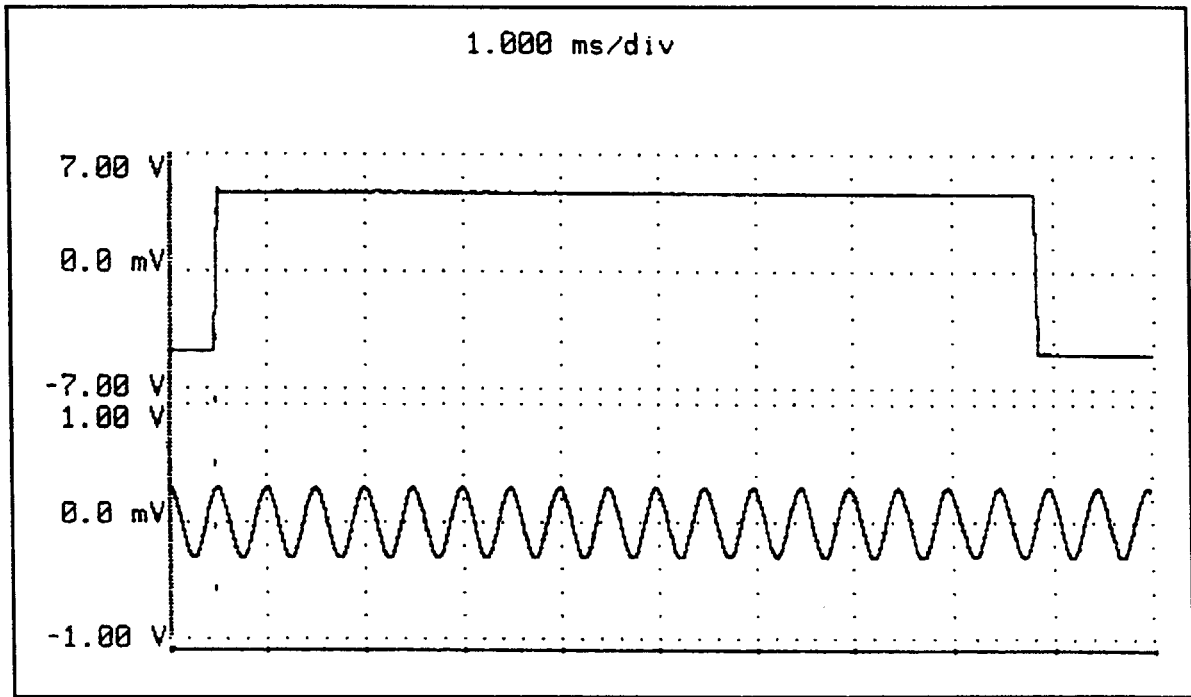

Figure 4-18. Signal PCB Waveforms: TP1 & TP9 - Settings: 2000 Hz.

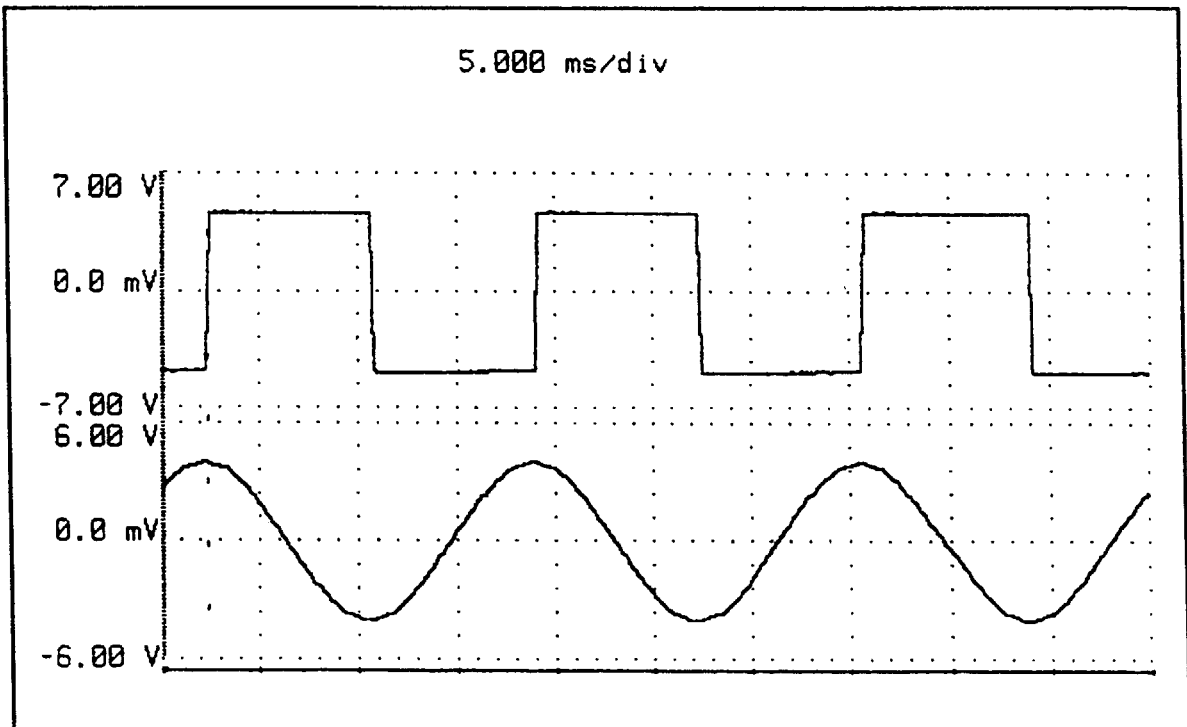

Figure 4-19. Signal PCB Waveforms: TP1 & TP10 - Settings: 50/60 Hz, LOW range.

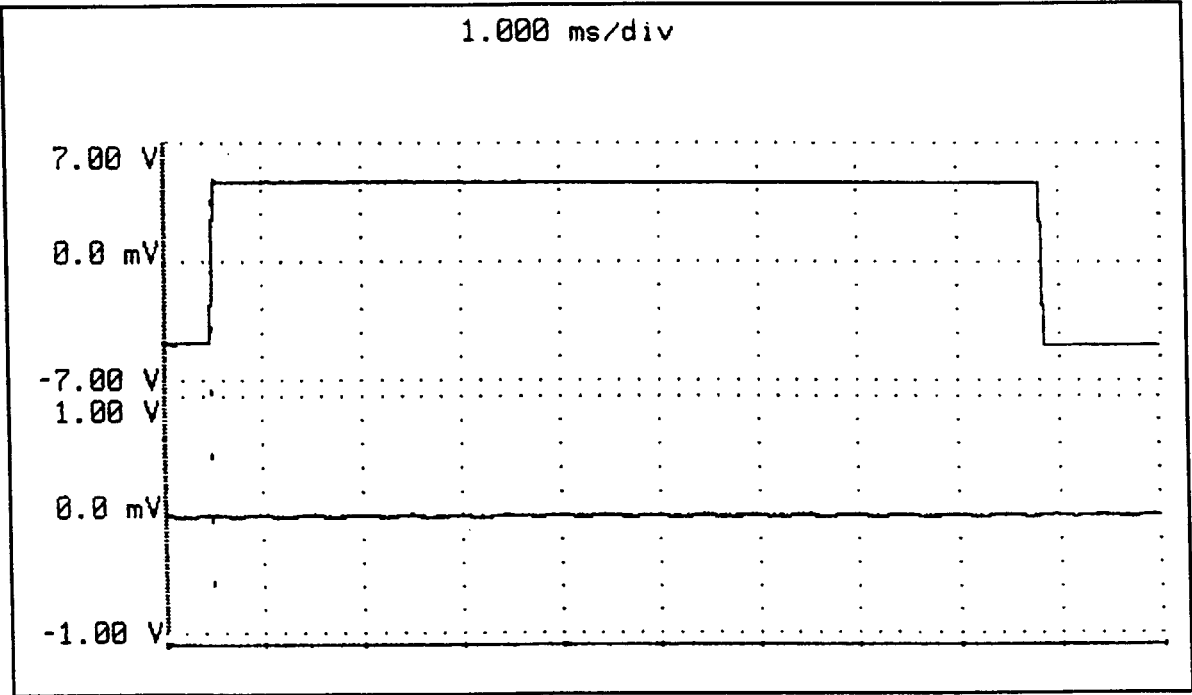

Figure 4-20. Signal PCB Waveforms: TP1 & TP11 - Settings: 2000 Hz, open circuit, LOW range.

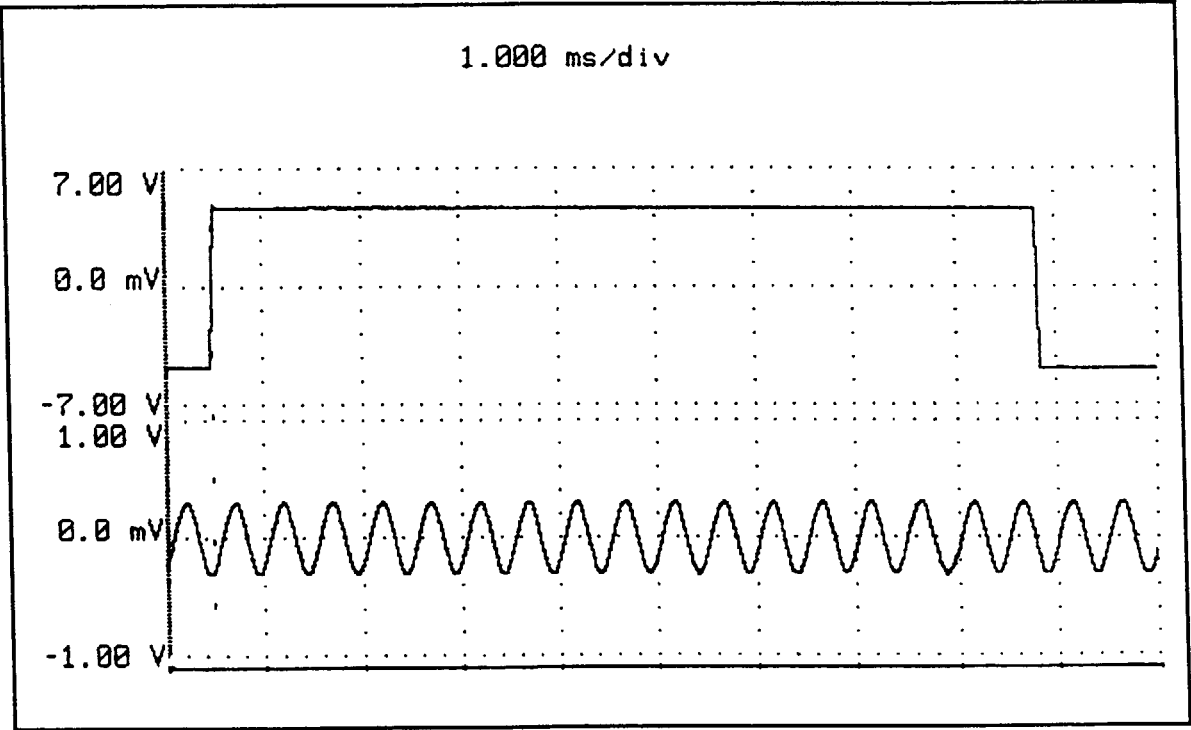

Figure 4-21. Signal PCB Waveforms: TP1 & TP11 - Settings: 2000 Hz, short circuit, LOW range.

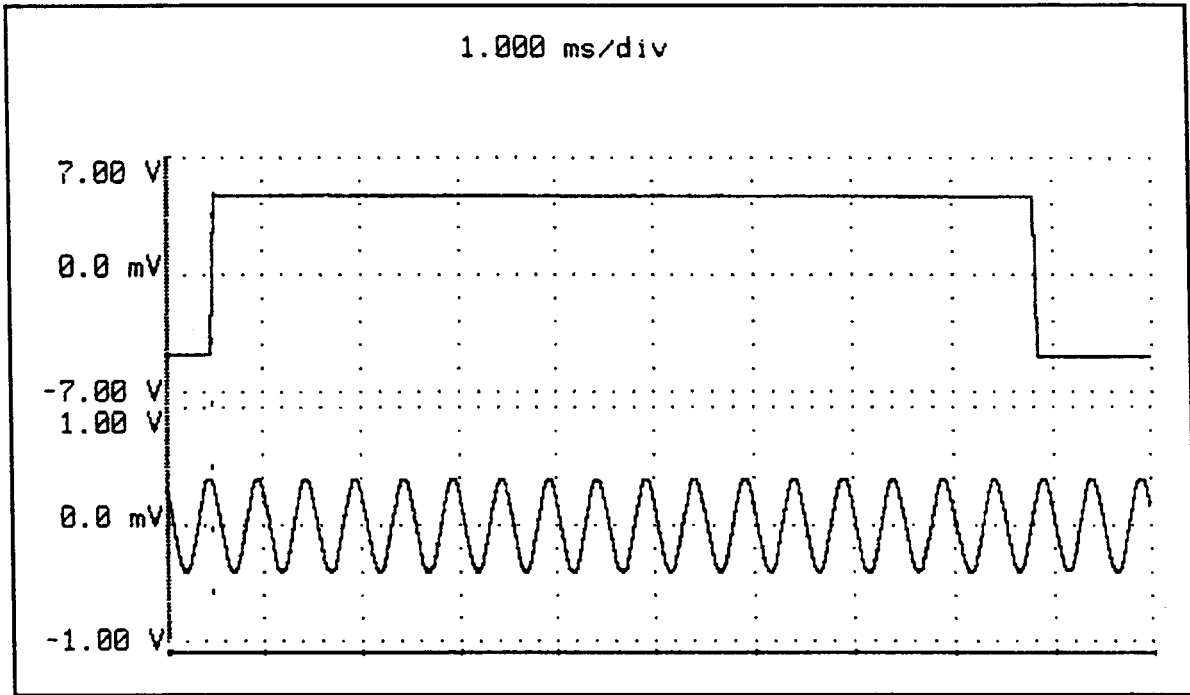

Figure 4-22. Signal PCB Waveforms: TP1 & TP12 - Settings: 2000 Hz, open circuit, LOW range.

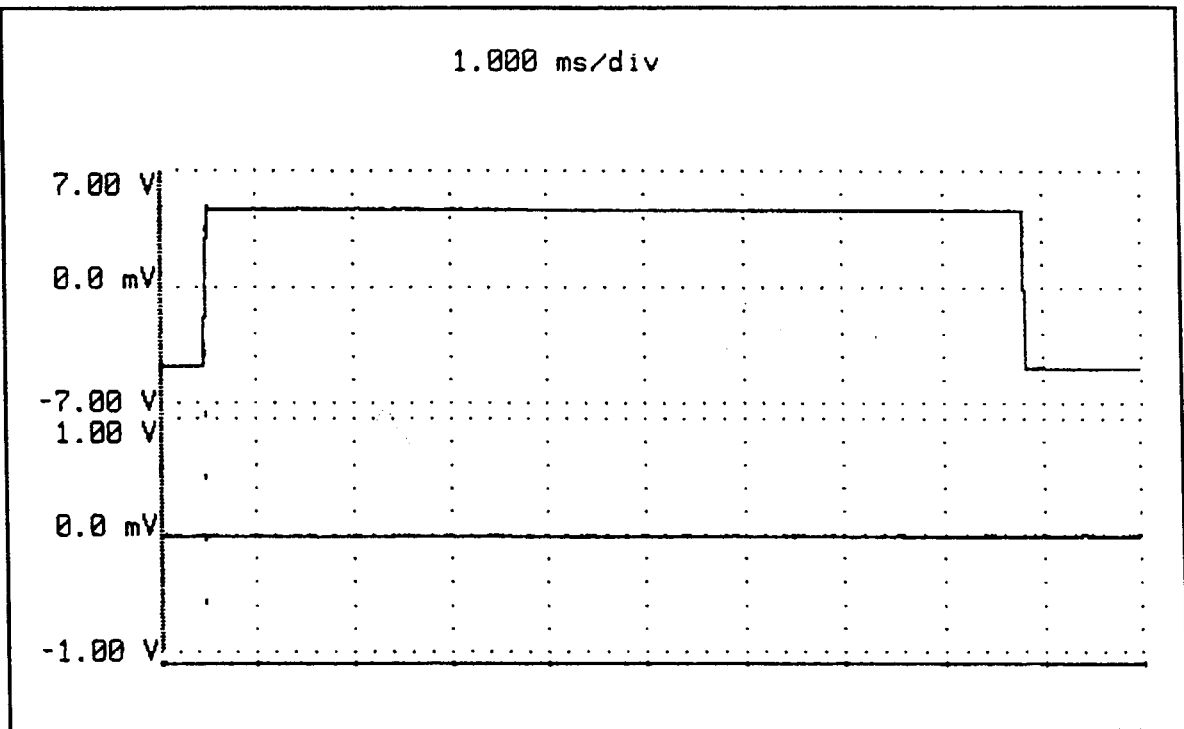

Figure 4-23. Signal PCB Waveforms: TP1 & TP12 - Settings: 2000 Hz, short circuit, LOW range.

# SECTION 5

## LIST OF REPLACEABLE PARTS

### 5-1. INTRODUCTION

This section contains the parts list for the 2000. The components of each assembly are listed alphanumerically by reference designation. Both electrical and mechanical components are listed by reference designation, and can be referenced to illustrations and schematics.

Parts lists include the following information:

1. Reference Designation (REF DES)
2. Description of each part (Description)
3. Huntron Part Number (Huntron P/N)
4. Federal Supply Code for Manufacturers (FSCM)
5. Manufacturer's Part Number

Numbers in parenthesis following the description refer to the total quantity of the part for that assembly.

### 5-2. HOW TO OBTAIN PARTS

Components may be ordered directly from a manufacturer by using the part description, or from Huntron Instruments, Inc. or its authorized distributors by using the HUNTRON PART NUMBER. In the event the part you order has been replaced by a new part, the replacement will be accompanied by an explanatory note and installation instructions if necessary.

To ensure prompt and efficient handling of your order, please include the following information:

1. Quantity
2. Huntron Part Number
3. Part Description
4. Reference Designation
5. Printed Circuit Board Part Number and Revision Letter
6. Instrument Model and Serial Number

#### CAUTION

**Devices indicated by an asterisk (\*) in the list of replaceable parts are subject to damage by static discharge.**



LIST OF REPLACEABLE PARTS

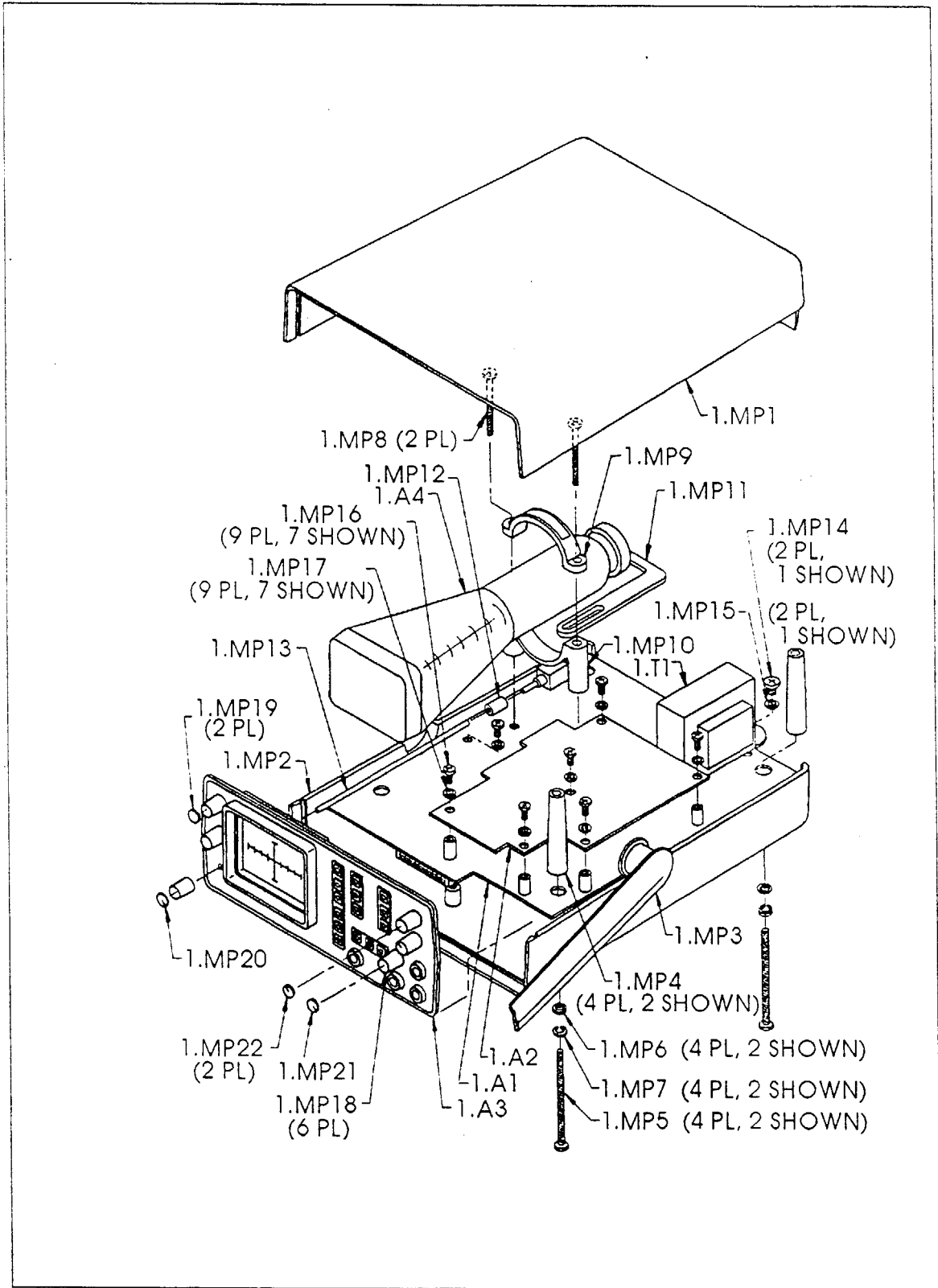

Figure 5-1. Final Assembly.

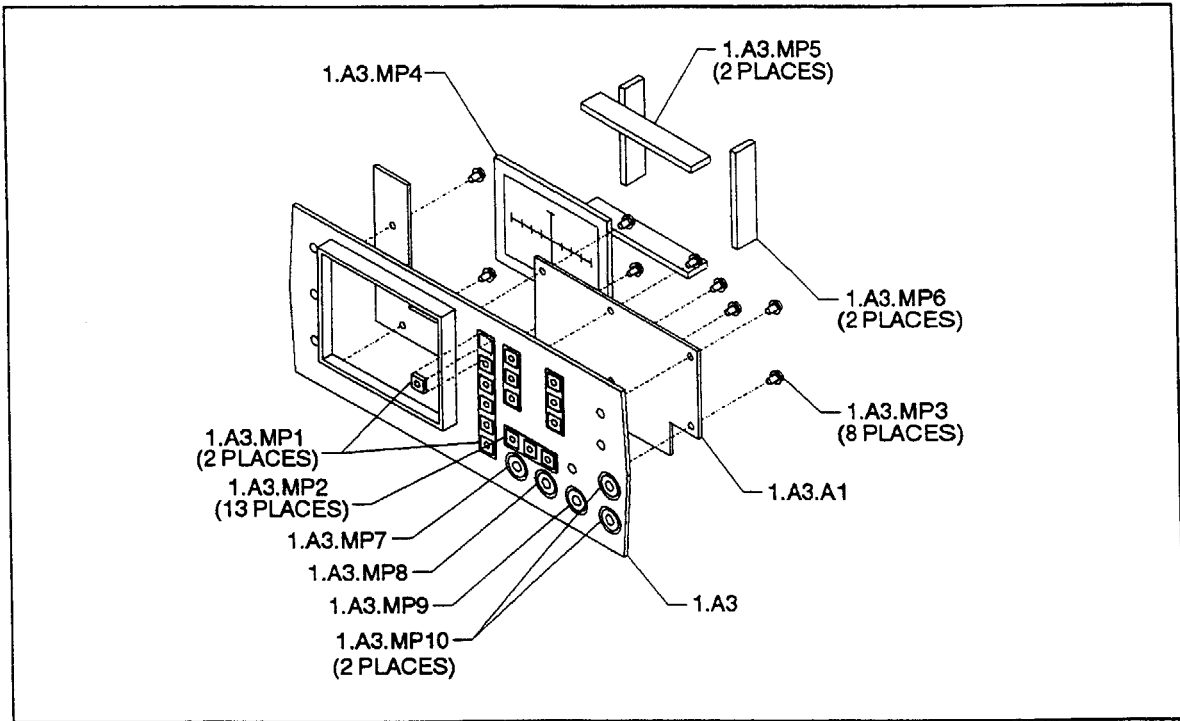

Figure 5-2. Front Control Assembly.

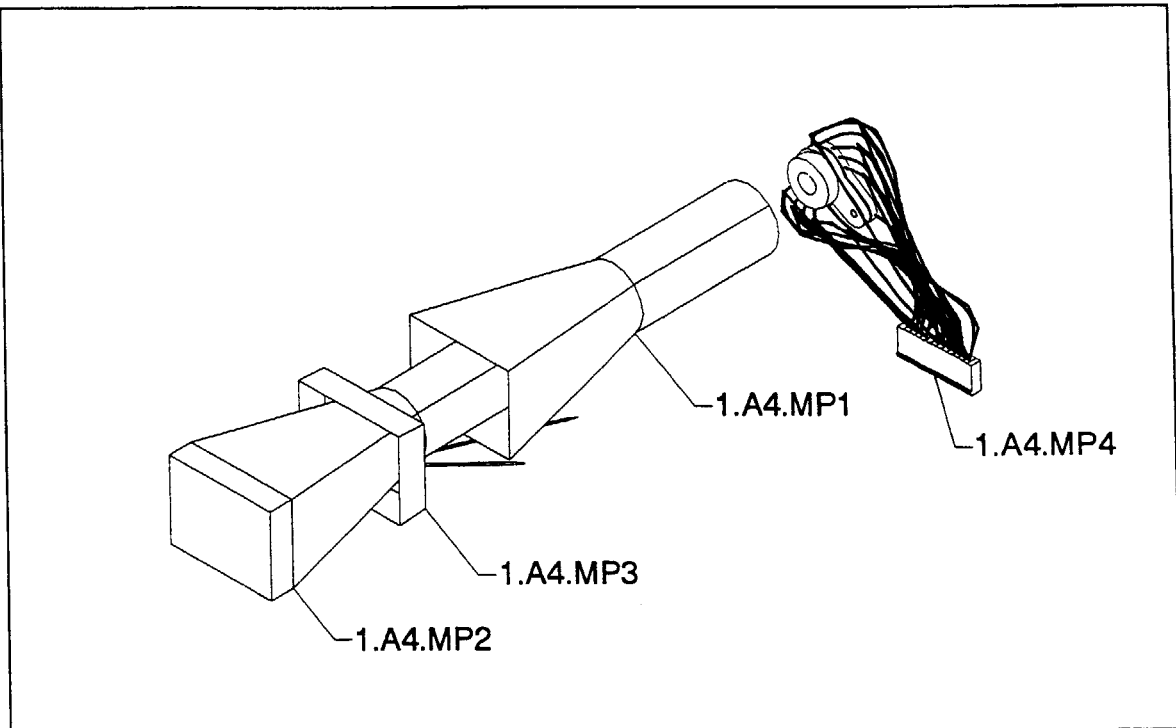

Figure 5-3. CRT Assembly.

LIST OF REPLACEABLE PARTS

FINAL ASSEMBLY PARTS LIST (refer to Figure 5-1)

REF DES	DESCRIPTION	HUNTRON P/N	FSCM	MANUFACTURERS PART NUMBER
1	* Final Assembly			
1.A1	* Main PCB Assembly	06-3041	57705	06-3041
1.A2	* Signal PCB Assembly	06-3042	57705	06-3042
1.A3	Front Control Assembly	06-1058	57705	06-1058
1.A4	CRT Assembly	06-2062	57705	06-2062
1.MP1	Top, Case	01-1155	57705	01-1155
1.MP2	Bottom, Case	01-1156	57705	01-1156
1.MP3	Handle, Case	01-1157	57705	01-1157
1.MP4	Spacer, Case (4)	01-1158	57705	01-1158
1.MP5	Screw, Philips P.H., 3" 6-32 (4)	07-3049	73734	16078
1.MP6	Washer, Flat Steel #6 (4)	07-3055	73734	1404
1.MP7	Washer, Lock Split #6 (4)	07-3066	73734	98208
1.MP8	Screw, Philips P.H., 2" 6-32 (2)	07-3065	73734	19055
1.MP9	Cap, CRT Yoke	01-1165	57705	01-1165
1.MP10	Base, CRT Yoke	01-1166	57705	01-1166
1.MP11	Stop, CRT	01-1167	57705	01-1167
1.MP12	Coupler, 1/8" to 1/8"	07-3056	83330	180
1.MP13	Shaft, Intensity, 1/8"D x 7.125"L	07-2086	57705	07-2086
1.MP14	Screw, Philips P.H., 3/8" 8-32 (2)	07-3067	73734	19064
1.MP15	Washer, Internal Star #8 (2)	07-3062	73734	1305
1.MP16	Screw, Philips P.H., 3/8" 4-40 (9)	07-3051	73734	19024
1.MP17	Washer, Internal Star #4 (9)	07-3020	73734	1302
1.MP18	Knob, Black (6)	07-2064	59270	S100.125-Black
1.MP19	Knob Cap, Black (2)	07-2065	59270	C100-Black
1.MP20	Knob Cap, Red w/Line	07-2069	59270	C101-Red
1.MP21	Knob Cap, Black w/Line	07-2067	59270	C101-Black
1.MP22	Knob Cap, Blue w/Line (2)	07-2066	59270	C101-Blue
1.MP23	Feet, Rubber, 1/2" sq. (2)	07-2073	83330	SJ-5018
1.T1	Power Transformer(115V/230V)	06-6028	57705	06-6028
	Power Transformer(100V)	06-6029	57705	06-6029

## LIST OF REPLACEABLE PARTS

## MAIN PCB ASSEMBLY PARTS LIST

REF DES	DESCRIPTION	HUNTRON P/N	FSCM	MANUFACTURERS PART NUMBER
1.A1	Main PCB Assembly	06-3041	57705	06-3041
1.A1.C1	Cap, Mono .1 $\mu$ F, 50V	03-3028	54583	FK20Y5V1H104M
1.A1.C2	Cap, Mono .1 $\mu$ F, 50V	03-3028	54583	FK20Y5V1H104M
1.A1.C3	Cap, Mono .001 $\mu$ F, 50V	03-3027	54583	FK11X7R1H102K
1.A1.C4	Cap, Mono .001 $\mu$ F, 50V	03-3027	54583	FK11X7R1H102K
1.A1.C5	Cap, Mono 100pF, 50V	03-3071	54583	FK11COG1H101J
1.A1.C6	Cap, Tant 47 $\mu$ F, 16V	03-3064	31433	T350J476M016AS
1.A1.C7	Cap, Film .015 $\mu$ F, 63V	03-3080	68919	MKS2.015/50/5
1.A1.C8	Cap, Film 1000pF, 100V	03-3059	68919	FKS2.001/100/5
1.A1.C9	Cap, Mono 270pF, 50V	03-3058	54583	FK11COG1H271J
1.A1.C10	Not Used			
1.A1.C11	Cap, Mono .1 $\mu$ F, 50V	03-3028	54583	FK20Y5V1H104M
1.A1.C12	Cap, Mono .1 $\mu$ F, 50V	03-3028	54583	FK20Y5V1H104M
1.A1.C13	Cap, Mono .1 $\mu$ F, 50V	03-3028	54583	FK20Y5V1H104M
1.A1.C14	Cap, Mono .1 $\mu$ F, 50V	03-3028	54583	FK20Y5V1H104M
1.A1.C15	Cap, Ceramic .02 $\mu$ F, 1kV	03-3004	56289	5GA-S20
1.A1.C16	Cap, Electrolytic 1 $\mu$ F, 450V	03-3040	00199	CEO4W2W010B
1.A1.C17	Cap, Electrolytic 1 $\mu$ F, 450V	03-3040	00199	CEO4W2W010B
1.A1.C18	Cap, Electrolytic 1 $\mu$ F, 450V	03-3040	00199	CEO4W2W010B
1.A1.C19	Cap, Electrolytic 1 $\mu$ F, 450V	03-3040	00199	CEO4W2W010B
1.A1.C20	Cap, Ceramic .01 $\mu$ F, 2kV	03-3042	80201	HS103M
1.A1.C21	Cap, Ceramic .1 $\mu$ F, 500V	03-3007	56289	5GA-P10
1.A1.C22	Cap, Electrolytic 22 $\mu$ F, 250V	03-3055	00199	CEUSM2E220
1.A1.C23	Cap, Electrolytic 2200 $\mu$ F, 25V	03-3056	00199	CEUSM1E222
1.A1.C24	Cap, Electrolytic 2200 $\mu$ F, 25V	03-3056	00199	CEUSM1E222
1.A1.C25	Cap, Tant 10 $\mu$ F, 25V	03-3011	31433	T350E106M025AS
1.A1.C26	Cap, Tant 10 $\mu$ F, 25V	03-3011	31433	T350E106M025AS
1.A1.C27	Cap, Mono .1 $\mu$ F, 50V	03-3028	54583	FK20Y5V1H104M
1.A1.C28	Cap, Mono .1 $\mu$ F, 50V	03-3028	54583	FK20Y5V1H104M
1.A1.C29	Cap, Mono .1 $\mu$ F, 50V	03-3028	54583	K20Y5V1H104M
1.A1.C30	Cap, Mono .1 $\mu$ F, 50V	03-3028	54583	FK20Y5V1H104M
1.A1.C31	Not Used			
1.A1.C32	Cap, Mono .1 $\mu$ F, 50V	03-3028	54583	FK20Y5V1H104M
1.A1.C33	Cap, Mono .001 $\mu$ F, 50V	03-3027	54583	FK11X7R1H102K
1.A1.C34	Cap, Electrolytic 1 $\mu$ F, 450V	03-3040	00199	CEO4W2W010B
1.A1.C35	Cap, Electrolytic 2.2 $\mu$ F, 50V	03-3046	00199	CEUSM1H2R2
1.A1.C36	Cap, Mono .001 $\mu$ F, 50V	03-3027	54583	FK11X7R1H102K
1.A1.C37	Cap, Tant 10 $\mu$ F, 25V	03-3011	31433	T350E106M025AS
1.A1.D1	Diode, 3KV	04-4016	11961	HV30
1.A1.D2	Diode, 3KV	04-4016	11961	HV30
1.A1.D3	Diode, 600V	04-4012	71744	1N4005
1.A1.D4	Diode, 600V	04-4012	71744	1N4005
1.A1.D5	Diode, 600V	04-4012	71744	1N4005
1.A1.D6	Diode, 600V	04-4012	71744	1N4005
1.A1.D7	Diode, 600V	04-4012	71744	1N4005
1.A1.D8	Diode, 600V	04-4012	71744	1N4005
1.A1.D9	Diode, 600V	04-4012	71744	1N4005
1.A1.D10	Diode, 600V	04-4012	71744	1N4005
1.A1.D11	Diode, Signal	04-4007	07263	1N914
1.A1.D12	Diode, Signal	04-4007	07263	1N914
1.A1.D13	Diode, Signal	04-4007	07263	1N914
1.A1.D14	Diode, Signal	04-4007	07263	1N914
1.A1.D15	Diode, Signal	04-4007	07263	1N914
1.A1.D16	Diode, Signal	04-4007	07263	1N914
1.A1.D17	Diode, Signal	04-4007	07263	1N914
1.A1.D18	Diode, Signal	04-4007	07263	1N914

LIST OF REPLACEABLE PARTS

MAIN PCB ASSEMBLY PARTS LIST (con't)

REF DES	DESCRIPTION	HUNTRON P/N	FSCM	MANUFACTURERS PART NUMBER
1.A1.D19	Diode, Signal	04-4007	07263	1N914
1.A1.D20	Diode, Signal	04-4007	07263	1N914
1.A1.D21	Diode, Signal	04-4007	07263	1N914
1.A1.F1	Fuse, 1/4 Amp, 250V, Type AGC	02-0010	75915	312.250
1.A1.J1	Connector, Female, 6 pin	07-1179	22526	65780-042
1.A1.J2	Connector, Female, 6 pin	07-1179	22526	65780-042
1.A1.J3	Not Used			
1.A1.J4	Connector, Female, 10 pin	07-1180	22526	65780-046
1.A1.J5	Not Used			
1.A1.J6	Connector, Female, Dual Row, 22 pin	07-1181	15636	008251-044-000-021
1.A1.MP1	PCB, Main	07-7715	57705	07-7715
1.A1.MP2	Clip, Fuse (2)	07-2074	75915	102071
1.A1.MP3	Not Used			
1.A1.MP4	Not Used			
1.A1.MP5	Screw, Philips P.H 3/8" 4-40 (5)	07-3051	73734	19024
1.A1.MP6	Washer, Internal Star #4 (5)	07-3020	73734	1302
1.A1.MP7	Not Used			
1.A1.MP8	Insulator, Capacitor (5)	07-2077	15819	343-10
1.A1.MP9	Not Used			
1.A1.MP10	Heat Sink	07-2080	30161	5786B
1.A1.MP11	Bushing, Shoulder, Nylon	07-3053	91833	3102
1.A1.MP12	Insulator, Regulator	07-2075	8W262	R601157911674
1.A1.MP13	Not Used			
1.A1.MP14	Nut, Hex, 4-40 (2)	07-3052	73734	70250
1.A1.P1-P4	Not Used			
1.A1.P5	Connector, Male, 2 pin, Polarized	07-1153	27264	09-65-1021
1.A1.P6	Not Used			
1.A1.P7	Connector, Male, 14 pin, Polarized	07-1174	27264	09-65-1141
1.A1.P8	Connector, Male, 12 pin, Polarized	07-1158	27264	09-65-1121
1.A1.P9	Power Receptacle	07-1177	82389	EAC-303
1.A1.P10	Connector, Male, 4 pin, Recessed, Polarized	07-1178	00779	102203-1
1.A1.Q1	Not Used			
1.A1.Q2	Transistor, PNP	05-5039	27014	2N3906
1.A1.Q3	Transistor, NPN 500V	05-5016	01295	TIP50
1.A1.Q4	Transistor, NPN	05-5013	27014	PN2222
1.A1.Q5	Transistor, PNP	05-5039	27014	2N3906
1.A1.Q6	Transistor, NPN 300V	05-5003	04713	MPSA42
1.A1.Q7	Transistor, NPN 300V	05-5003	04713	MPSA42
1.A1.Q8	Transistor, NPN 300V	05-5003	04713	MPSA42
1.A1.Q9	Transistor, NPN 300V	05-5003	04713	MPSA42
1.A1.Q10	Transistor, NPN 300V	05-5003	04713	MPSA42
1.A1.Q11	Transistor, NPN 300V	05-5003	04713	MPSA42
1.A1.Q12	Transistor, NPN	05-5013	27014	PN2222
1.A1.Q13	Transistor, PNP	05-5039	27014	2N3906
1.A1.Q14	Transistor, NPN	05-5013	27014	PN2222
1.A1.Q15	Transistor, NPN	05-5013	27014	PN2222
1.A1.Q16	Transistor, NPN	05-5013	27014	PN2222
1.A1.Q17	Transistor, NPN	05-5013	27014	PN2222
1.A1.R1	Res CF, 16K $\Omega$ , 5%, 1/4W	02-2134	09021	CF 1/4 16K J
1.A1.R2	Res CF, 3.9K $\Omega$ , 5%, 1/4W	02-2221	09021	CF 1/4 3.9K J
1.A1.R3	Not Used			
1.A1.R4	Res CF, 10K $\Omega$ , 5%, 1/4W	02-2137	09021	CF 1/4 10K J
1.A1.R5	Res CF, 10K $\Omega$ , 5%, 1/4W	02-2137	09021	CF 1/4 10K J

## LIST OF REPLACEABLE PARTS

## MAIN PCB ASSEMBLY PARTS LIST (con't)

REF DES	DESCRIPTION	HUNTRON P/N	FSCM	MANUFACTURERS PART NUMBER
1.A1.R6	Res CF, 20K $\Omega$ , 5%, 1/4W	02-2082	09021	CF 1/4 20K J
1.A1.R7	Res CF, 47K $\Omega$ , 5%, 1/4W	02-2143	09021	CF 1/4 47K J
1.A1.R8	Res CF, 47K $\Omega$ , 5%, 1/4W	02-2143	09021	CF 1/4 47K J
1.A1.R9	Res CF, 33K $\Omega$ , 5%, 1/4W	02-2216	09021	CF 1/4 33K J
1.A1.R10	Res MF, 10.0K $\Omega$ , 1%, 1/4W	02-2189	09021	MF55D1002F
1.A1.R11	Res MF, 10.0K $\Omega$ , 1%, 1/4W	02-2189	09021	MF55D1002F
1.A1.R12	Res MF, 10.0K $\Omega$ , 1%, 1/4W	02-2189	09021	MF55D1002F
1.A1.R13	Res MF, 10.0K $\Omega$ , 1%, 1/4W	02-2189	09021	MF55D1002F
1.A1.R14	Res MF, 20.0K $\Omega$ , 1%, 1/4W	02-2188	09021	MF55D2002F
1.A1.R15	Res CF, 100 $\Omega$ , 5%, 1W	02-2205	09021	CF 1 100 J
1.A1.R16	Res CF, 100 $\Omega$ , 5%, 1W	02-2205	09021	CF 1 100 J
1.A1.R17	Res CF, 100K $\Omega$ , 5%, 1/4W	02-2139	09021	CF 1/4 100K J
1.A1.R18	Res CF, 10K $\Omega$ , 5%, 1/4W	02-2137	09021	CF 1/4 10K J
1.A1.R19	Res CF, 1M $\Omega$ , 5%, 1/4W	02-2130	09021	CF 1/4 1M J
1.A1.R20	Res CF, 10K $\Omega$ , 5%, 1/4W	02-2137	09021	CF 1/4 10K J
1.A1.R21	Res CF, 10K $\Omega$ , 5%, 1/4W	02-2137	09021	CF 1/4 10K J
1.A1.R22	Res CF, 4.7K $\Omega$ , 5%, 1/4W	02-2145	09021	CF 1/4 4.7K J
1.A1.R23	Res CF, 10M $\Omega$ , 5%, 1/2W	02-2102	09021	CF 1/2 10M J
1.A1.R24	Res CF, 10M $\Omega$ , 5%, 1/2W	02-2102	09021	CF 1/2 10M J
1.A1.R25	Res CF, 10M $\Omega$ , 5%, 1/2W	02-2102	09021	CF 1/2 10M J
1.A1.R26	Res CF, 10M $\Omega$ , 5%, 1/2W	02-2102	09021	CF 1/2 10M J
1.A1.R27	Res CF, 2M $\Omega$ , 5%, 1/4W	02-2129	09021	CF 1/4 2M J
1.A1.R28	Res CF, 1K $\Omega$ , 5%, 1/4W	02-2125	09021	CF 1/4 1K J
1.A1.R29	Res CF, 2.2M $\Omega$ , 5%, 1/4W	02-2131	09021	CF 1/4 2.2M J
1.A1.R30	Res CF, 2.2K $\Omega$ , 5%, 1/4W	02-2079	09021	CF 1/4 2.2K J
1.A1.R31	Not Used			
1.A1.R32	Res MO, High Voltage 5M $\Omega$ , 5%, 1/2W	02-2088	63060	MOX-300-005004F
1.A1.R33	Not Used			
1.A1.R34	Res VAR, 10K $\Omega$ , 25%	02-1044	51406	RVS0707V-100-3-103
1.A1.R35	Res CF, 12K $\Omega$ , 5%, 1/4W	02-2238	09021	CF 1/4 12K J
1.A1.R36	Res CF, 180K $\Omega$ , 5%, 1/4W	02-2124	09021	CF 1/4 180K J
1.A1.R37	Res CF, 1.8K $\Omega$ , 5%, 1/4W	02-2128	09021	CF 1/4 1.8K J
1.A1.R38	Res CF, 1.8K $\Omega$ , 5%, 1/4W	02-2128	09021	CF 1/4 1.8K J
1.A1.R39	Res CF, 4.7M $\Omega$ , 5%, 1/4W	02-2127	09021	CF 1/4 4.7M J
1.A1.R40	Res VAR, 1M $\Omega$ , 25%	02-1035	51406	RVS0707V-100-3-106
1.A1.R41	Not Used			
1.A1.R42	Res MO, High Voltage 5M $\Omega$ , 5%, 1/2W	02-2088	63060	MOX-300-005004F
1.A1.R43	Not Used			
1.A1.R44	Res VAR, 1M $\Omega$ , 25%	02-1030	54869	PT15-WB
1.A1.R45(S1)	Pot, Control, 500K $\Omega$ , w/switch	02-1039	32997	85C2AE28A23R53
1.A1.R46	Res CF, 220K $\Omega$ , 5%, 1/2W	02-2204	09021	CF 1/2 220K J
1.A1.R47	Res CF, 68K $\Omega$ , 5%, 1/4W	02-2103	09021	CF 1/4 68K J
1.A1.R48	Res CF, 82K $\Omega$ , 5%, 1/4W	02-2224	09021	CF 1/4 82K J
1.A1.R49	Res CF, 39K $\Omega$ , 5%, 1/4W	02-2239	09021	CF 1/4 39K J
1.A1.R50	Res CF, 180K $\Omega$ , 5%, 1/4W	02-2124	09021	CF 1/4 180K J
1.A1.R51	Res CF, 180K $\Omega$ , 5%, 1/4W	02-2124	09021	CF 1/4 180K J
1.A1.R52	Res CF, 1K $\Omega$ , 5%, 1/4W	02-2125	09021	CF 1/4 1K J
1.A1.R53	Res CF, 1K $\Omega$ , 5%, 1/4W	02-2125	09021	CF 1/4 1K J
1.A1.R54	Res CF, 1.6K $\Omega$ , 5%, 1/4W	02-2135	09021	CF 1/4 1.6K J
1.A1.R55	Res CF, 3.6K $\Omega$ , 5%, 1/4W	02-2202	09021	CF 1/4 3.6K J
1.A1.R56	Res CF, 15K $\Omega$ , 5%, 1/4W	02-2151	09021	CF 1/4 15K J
1.A1.R57	Res CF, 180K $\Omega$ , 5%, 1/4W	02-2124	09021	CF 1/4 180K J
1.A1.R58	Res CF, 180K $\Omega$ , 5%, 1/4W	02-2124	09021	CF 1/4 180K J
1.A1.R59	Res CF, 1K $\Omega$ , 5%, 1/4W	02-2125	09021	CF 1/4 1K J
1.A1.R60	Res CF, 1K $\Omega$ , 5%, 1/4W	02-2125	09021	CF 1/4 1K J
1.A1.R61	Res CF, 1.6K $\Omega$ , 5%, 1/4W	02-2135	09021	CF 1/4 1.6K J
1.A1.R62	Res CF, 100K $\Omega$ , 5%, 1/4W	02-2139	09021	CF 1/4 100K J
1.A1.R63	Not Used			
1.A1.R64	Not Used			

LIST OF REPLACEABLE PARTS

MAIN PCB ASSEMBLY PARTS LIST (con't)

REF DES	DESCRIPTION	HUNTRON P/N	FSCM	MANUFACTURERS PART NUMBER
1.A1.R65	Res CF, 10K $\Omega$ , 5%, 1/4W	02-2137	09021	CF 1/4 10K J
1.A1.R66	Res CF, 10K $\Omega$ , 5%, 1/4W	02-2137	09021	CF 1/4 10K J
1.A1.R67	Res CF, 10K $\Omega$ , 5%, 1/4W	02-2137	09021	CF 1/4 10K J
1.A1.R68	Res CF, 24K $\Omega$ , 5%, 1/4W	02-2179	09021	CF 1/4 24K J
1.A1.R69	Res CF, 24K $\Omega$ , 5%, 1/4W	02-2179	09021	CF 1/4 24K J
1.A1.R70	Res CF, 10K $\Omega$ , 5%, 1/4W	02-2137	09021	CF 1/4 10K J
1.A1.R71	Res CF, 10K $\Omega$ , 5%, 1/4W	02-2137	09021	CF 1/4 10K J
1.A1.R72	Res CF, 10K $\Omega$ , 5%, 1/4W	02-2137	09021	CF 1/4 10K J
1.A1.R73	Res CF, 10K $\Omega$ , 5%, 1/4W	02-2137	09021	CF 1/4 10K J
1.A1.R74	Res CF, 10K $\Omega$ , 5%, 1/4W	02-2137	09021	CF 1/4 10K J
1.A1.R75	Res CF, 10K $\Omega$ , 5%, 1/4W	02-2137	09021	CF 1/4 10K J
1.A1.R76	Res CF, 180 $\Omega$ , 5%, 1/4W	02-2101	09021	CF 1/4 180 J
1.A1.R77	Res CF, 10K $\Omega$ , 5%, 1/4W	02-2137	09021	CF 1/4 10K J
1.A1.R78	Res CF, 180 $\Omega$ , 5%, 1/4W	02-2101	09021	CF 1/4 180 J
1.A1.R79	Res CF, 180 $\Omega$ , 5%, 1/4W	02-2101	09021	CF 1/4 180 J
1.A1.R80	Res CF, 10K $\Omega$ , 5%, 1/4W	02-2137	09021	CF 1/4 10K J
1.A1.R81	Res CF, 47K $\Omega$ , 5%, 1/4W	02-2143	09021	CF 1/4 47K J
1.A1.R82	Res CF, 100 $\Omega$ , 5%, 1/4W	02-2181	09021	CF 1/4 100 J
1.A1.R83	Res CF, 180 $\Omega$ , 5%, 1/4W	02-2101	09021	CF 1/4 180 J
1.A1.R84	Res CF, 10K $\Omega$ , 5%, 1/4W	02-2137	09021	CF 1/4 10K J
1.A1.R85	Res CF, 180 $\Omega$ , 5%, 1/4W	02-2101	09021	CF 1/4 180 J
1.A1.R86	Res CF, 180 $\Omega$ , 5%, 1/4W	02-2101	09021	CF 1/4 180 J
1.A1.R87	Res CF, 180 $\Omega$ , 5%, 1/4W	02-2101	09021	CF 1/4 180 J
1.A1.R88	Res CF, 180 $\Omega$ , 5%, 1/4W	02-2101	09021	CF 1/4 180 J
1.A1.R89	Res CF, 180 $\Omega$ , 5%, 1/4W	02-2101	09021	CF 1/4 180 J
1.A1.R90	Res CF, 10K $\Omega$ , 5%, 1/4W	02-2137	09021	CF 1/4 10K J
1.A1.R91	Res CF, 10K $\Omega$ , 5%, 1/4W	02-2137	09021	CF 1/4 10K J
1.A1.R92	Res CF, 10K $\Omega$ , 5%, 1/4W	02-2137	09021	CF 1/4 10K J
1.A1.R93	Res CF, 10K $\Omega$ , 5%, 1/4W	02-2137	09021	CF 1/4 10K J
1.A1.R94	Res CF, 10K $\Omega$ , 5%, 1/4W	02-2137	09021	CF 1/4 10K J
1.A1.R95	Res CF, 10K $\Omega$ , 5%, 1/4W	02-2137	09021	CF 1/4 10K J
1.A1.R96	Res CF, 10K $\Omega$ , 5%, 1/4W	02-2137	09021	CF 1/4 10K J
1.A1.R97	Res CF, 180 $\Omega$ , 5%, 1/4W	02-2101	09021	CF 1/4 180 J
1.A1.R98	Res CF, 180 $\Omega$ , 5%, 1/4W	02-2101	09021	CF 1/4 180 J
1.A1.R99	Res CF, 180 $\Omega$ , 5%, 1/4W	02-2101	09021	CF 1/4 180 J
1.A1.R100	Res CF, 10K $\Omega$ , 5%, 1/4W	02-2137	09021	CF 1/4 10K J
1.A1.R101	Res CF, 10K $\Omega$ , 5%, 1/4W	02-2137	09021	CF 1/4 10K J
1.A1.R102	Res CF, 10K $\Omega$ , 5%, 1/4W	02-2137	09021	CF 1/4 10K J
1.A1.R103	Res CF, 180 $\Omega$ , 5%, 1/4W	02-2101	09021	CF 1/4 180 J
1.A1.R104	Res CF, 180 $\Omega$ , 5%, 1/4W	02-2101	09021	CF 1/4 180 J
1.A1.R105	Res CF, 180 $\Omega$ , 5%, 1/4W	02-2101	09021	CF 1/4 180 J
1A1.R106	Res CF, 68K $\Omega$ , 5%, 1/4W	02-2103	09021	CF 1/4 68K J
1.A1.S1(R45)	Switch, DPDT, Rotary, w/pot	02-1039	32997	85C2AE28A23R53
1.A1.S2	Switch, DPDT	07-4026	09353	V202-12-MS-02-QA
1.A1.U1	IC, Dual Comparator	05-5041	27014	LM393N
1.A1.U2	* IC, Hex Schmitt Trigger Inverter	05-5018	27014	74C14
1.A1.U3	* IC, Dual Monostable	05-5028	27014	CD4538B
1.A1.U4	* IC, Dual Monostable	05-5028	27014	CD4538B
1.A1.U5	* IC, 3PDT Analog Switch	05-5042	27014	CD4053B
1.A1.U6	* IC, Quad NAND Gate	05-5025	27014	CD4011B
1.A1.U7	* IC, Quad AND Gate	05-5038	27014	CD4081B
1.A1.U8	IC, Dual Op Amp	05-5035	27014	LF353N
1.A1.U9	* IC, 3PDT Analog Switch	05-5042	27014	CD4053B
1.A1.U10	IC, Power Op Amp	05-5019	07263	uA759
1.A1.U11	IC, Dual Op Amp	05-5012	04713	MC1458P
1.A1.U12	IC, Regulator +5V	05-5017	27014	LM7805CT
1.A1.U13	IC, Regulator -5V	05-5037	27014	LM7905CT

## LIST OF REPLACEABLE PARTS

## MAIN PCB ASSEMBLY PARTS LIST (con't)

REF DES	DESCRIPTION	HUNTRON P/N	FSCM	MANUFACTURERS PART NUMBER
1.A1.U14	* IC, Dual J-K Flip Flop	05-5024	27014	CD4027B
1.A1.U15	* IC, Hex Inverter Driver	05-5027	27014	CD4049
1.A1.U16	* IC, Dual J-K Flip Flop	05-5024	27014	CD4027B
1.A1.U17	* IC, Quad NAND Gate	05-5025	27014	CD4011B
1.A1.U18	* IC, Hex Schmitt Trigger Inverter	05-5018	27014	74C14
1.A1.U19	* IC, Hex Inverter Driver	05-5027	27014	CD4049
1.A1.U20	* IC, Quad NAND Gate	05-5025	27014	CD4011B
1.A1.U21	* IC, Quad NOR Gate	05-5026	27014	CD4001B
1.A1.U22	* IC, Quad R-S Latch	05-5022	27014	CD4044B
1.A1.U23	* IC, Quad NAND Gate	05-5025	27014	CD4011B
1.A1.U24	* IC, Quad AND Gate	05-5038	27014	CD4081B
1.A1.U25	* IC, Dual J-K Flip Flop	05-5024	27014	CD4027B
1.A1.U26	* IC, Dual 2/4 Decoder	05-5023	07263	CD4555B
1.A1.Z1	Varistor, 130V	02-0009	89730	V180ZA5



LIST OF REPLACEABLE PARTS

SIGNAL PCB ASSEMBLY PARTS LIST

REF DES	DESCRIPTION	HUNTRON P/N	FSCM	MANUFACTURERS PART NUMBER
1.A2	Signal PCB Assembly	06-3042	57705	06-3042
1.A2.C1	Cap, Tant 10 $\mu$ F, 25V	03-3011	31433	T350E106M025AS
1.A2.C2	Cap, Mono .1 $\mu$ F, 50V	03-3028	54583	FK20Y5V1H104M
1.A2.C3	Cap, Mono .1 $\mu$ F, 50V	03-3028	54583	FK20Y5V1H104M
1.A2.C4	Cap, Mono .1 $\mu$ F, 50V	03-3028	54583	FK20Y5V1H104M
1.A2.C5	Cap, Film .22 $\mu$ F 50V	03-3054	68919	MKS2 0.22/50/5
1.A2.C6	Cap, Tant 10 $\mu$ F, 25V	03-3011	31433	T350E106M025AS
1.A2.C7	Cap, Mono .1 $\mu$ F, 50V	03-3028	54583	FK20Y5V1H104M
1.A2.C8	Cap, Mono .1 $\mu$ F, 50V	03-3028	54583	FK20Y5V1H104M
1.A2.C9	Cap, Tant 10 $\mu$ F, 25V	03-3011	31433	T350E106M025AS
1.A2.C10	Cap, Mono .1 $\mu$ F, 50V	03-3028	54583	FK20Y5V1H104M
1.A2.C11	Cap, Film .1 $\mu$ F, 50V	03-3063	68919	MKS2 0.1/50/5
1.A2.C12	Cap, Tant 10 $\mu$ F, 25V	03-3011	31433	T350E106M025AS
1.A2.C13	Cap, Mono .1 $\mu$ F, 50V	03-3028	54583	FK20Y5V1H104M
1.A2.C14	Cap, Mono .1 $\mu$ F, 50V	03-3028	54583	FK20Y5V1H104M
1.A2.C15	Cap, Mono .1 $\mu$ F, 50V	03-3028	54583	FK20Y5V1H104M
1.A2.C16	Cap, Tant 10 $\mu$ F, 25V	03-3011	31433	T350E106M025AS
1.A2.C17	Cap, Tant 10 $\mu$ F, 25V	03-3011	31433	T350E106M025AS
1.A2.C18	Cap, Tant 10 $\mu$ F, 25V	03-3011	31433	T350E106M025AS
1.A2.C19	Cap, Tant 10 $\mu$ F, 25V	03-3011	31433	T350E106M025AS
1.A2.C20	Cap, Tant 1 $\mu$ F, 35V	03-3081	31433	T350A105K035AS
1.A2.C21	Cap, Tant 10 $\mu$ F, 25V	03-3011	31433	T350E106M025AS
1.A2.C22	Cap, Tant 10 $\mu$ F, 25V	03-3011	31433	T350E106M025AS
1.A2.C23	Cap, Trimmer, 3.0-15.0pF	03-3079	74970	274-0015-005
1.A2.C24	Cap, Mono .1 $\mu$ F, 50V	03-3028	54583	FK20Y5V1H104M
1.A2.C25	Cap, Mono .1 $\mu$ F, 50V	03-3028	54583	FK20Y5V1H104M
1.A2.C26	Cap, Mono .1 $\mu$ F, 50V	03-3028	54583	FK20Y5V1H104M
1.A2.C27	Cap, Mono .1 $\mu$ F, 50V	03-3028	54583	FK20Y5V1H104M
1.A2.C28	Cap, Mono .1 $\mu$ F, 50V	03-3028	54583	FK20Y5V1H104M
1.A2.C29	Cap, Mono .1 $\mu$ F, 50V	03-3028	54583	FK20Y5V1H104M
1.A2.D1	Diode, Signal	04-4007	07263	1N914
1.A2.D2	Diode, Signal	04-4007	07263	1N914
1.A2.D3	Diode, Signal	04-4007	07263	1N914
1.A2.D4	Diode, Signal	04-4007	07263	1N914
1.A2.D5	Diode, Signal	04-4007	07263	1N914
1.A2.D6	Diode, Signal	04-4007	07263	1N914
1.A2.D7	Diode, Signal	04-4007	07263	1N914
1.A2.D8	Diode, Signal	04-4007	07263	1N914
1.A2.D9	Diode, Signal	04-4007	07263	1N914
1.A2.D10	Diode, Signal	04-4007	07263	1N914
1.A2.D11	Diode, 600V	04-4012	71744	1N4005
1.A2.D12	Diode, 600V	04-4012	71744	1N4005
1.A2.F1	Fuse, 1/4 Amp, 250V, Type AGC	02-0010	75915	312.250
1.A2.K1	Relay, 2 Form A, DIP	07-4032	95348	832A-1
1.A2.K2	Relay, 2 Form A, DIP	07-4032	95348	832A-1
1.A2.K3	Relay, 2 Form A, DIP	07-4032	95348	832A-1
1.A2.K4	Relay, 2 Form A, DIP	07-4032	95348	832A-1
1.A2.K5	Relay, 1 Form C, DIP	07-4030	95348	835C-1
1.A2.MP1	PCB, Signal	07-7716	57705	07-7716
1.A2.MP2	Clip, Fuse (2)	07-2074	75915	102071
1.A2.MP3	Not Used			
1.A2.MP4	Screw, Philips P.H. 3/8" 4-40 (2)	07-3051	73734	19024

## LIST OF REPLACEABLE PARTS

## SIGNAL PCB ASSEMBLY PARTS LIST (con't)

REF DES	DESCRIPTION	HUNTRON P/N	FSCM	MANUFACTURERS PART NUMBER
1.A2.MP5	Washer, Internal Star #4 (2)	07-3020	73734	1302
1.A2.P1	Connector, Male, 6 pin	07-1182	22526	65500-406
1.A2.P2	Connector, Male, 6 pin	07-1182	22526	65500-406
1.A2.P3	Connector, Male, 3 pin, Polarized	07-1155	27264	09-65-1031
1.A2.P4	Connector, Male, 10 pin	07-1183	22526	65500-410
1.A2.Q1	Transistor, NPN	05-5013	27014	PN2222
1.A2.Q2	Transistor, NPN	05-5013	27014	PN2222
1.A2.R1	Res CF, 20K $\Omega$ , 5%, 1/4W	02-2082	09021	CF 1/4 20K J
1.A2.R2	Res CF, 10K $\Omega$ , 5%, 1/4W	02-2137	09021	CF 1/4 10K J
1.A2.R3	Res CF, 100K $\Omega$ , 5%, 1/4W	02-2139	09021	CF 1/4 100K J
1.A2.R4	Res CF, 1M $\Omega$ , 5%, 1/4W	02-2130	09021	CF 1/4 1M J
1.A2.R5	Res CF, 100K $\Omega$ , 5%, 1/4W	02-2139	09021	CF 1/4 100K J
1.A2.R6	Res CF, 1K $\Omega$ , 5%, 1/4W	02-2125	09021	CF 1/4 1K J
1.A2.R7	Res CF, 75K $\Omega$ , 5%, 1/4W	02-2180	09021	CF 1/4 75K J
1.A2.R8	Res MF, 73.2K $\Omega$ , 1%, 1/4W	02-2215	09021	MF55D7322F
1.A2.R9	Res VAR, 20K $\Omega$ , 25%	02-1032	51406	RVS0707V-100-3-203
1.A2.R10	Res CF, 10K $\Omega$ , 5%, 1/4W	02-2137	09021	CF 1/4 10K J
1.A2.R11	Res CF, 15K $\Omega$ , 5%, 1/4W	02-2151	09021	CF 1/4 15K J
1.A2.R12	Res VAR, 500 $\Omega$ , 25%	02-1031	51406	RVS0707V-100-3-501
1.A2.R13	Res CF, 1K $\Omega$ , 5%, 1/4W	02-2125	09021	CF 1/4 1K J
1.A2.R14	Res VAR, 1K $\Omega$ , 25%	02-1036	51406	RVS0707V-100-3-102
1.A2.R15	Res MF, 4.53K $\Omega$ , 1%, 1/4W	02-2227	09021	MF55D4531F
1.A2.R16	Res VAR, 5K $\Omega$ , 25%	02-1037	51406	RVS0707V-100-3-502
1.A2.R17	Res MF, 22.6K $\Omega$ , 1%, 1/4W	02-2228	09021	MF55D2262F
1.A2.R18	Res CF, 15K $\Omega$ , 5%, 1/4W	02-2151	09021	CF 1/4 15K J
1.A2.R19	Res VAR, 500, 25%	02-1031	51406	RVS0707V-100-3-501
1.A2.R20	Res CF, 1K $\Omega$ , 5%, 1/4W	02-2125	09021	CF 1/4 1K J
1.A2.R21	Res CF, 100K $\Omega$ , 5%, 1/4W	02-2139	09021	CF 1/4 100K J
1.A2.R22	Res CF, 4.7K $\Omega$ , 5%, 1/4W	02-2145	09021	CF 1/4 4.7K J
1.A2.R23	Res VAR, 5K $\Omega$ , 25%	02-1037	51406	RVS0707V-100-3-502
1.A2.R24	Res CF, 22K $\Omega$ , 5%, 1/4W	02-2157	09021	CF 1/4 22K J
1.A2.R25	Res CF, 18K $\Omega$ , 5%, 1/4W	02-2177	09021	CF 1/4 18K J
1.A2.R26	Res CF, 470 $\Omega$ , 5%, 1/4W	02-2098	09021	CF 1/4 470 J
1.A2.R27	Res CF, 39 $\Omega$ , 5%, 1/4W	02-2176	09021	CF 1/4 39 J
1.A2.R28	Res CF, 2K $\Omega$ , 5%, 1/4W	02-2184	09021	CF 1/4 2K J
1.A2.R29	Res CF, 39 $\Omega$ , 5%, 1/4W	02-2176	09021	CF 1/4 39 J
1.A2.R30	Res CF, 51 $\Omega$ , 5%, 1/4W	02-2175	09021	CF 1/4 51 J
1.A2.R31	Res CF, 3.6K $\Omega$ , 5%, 1/4W	02-2202	09021	CF 1/4 3.6K J
1.A2.R32	Res VAR, 10K $\Omega$ , 25%	02-1044	51406	RVS0707V-100-3-103
1.A2.R33	Res CF, 10K $\Omega$ , 5%, 1/4W	02-2137	09021	CF 1/4 10K J
1.A2.R34	Res CF, 100K $\Omega$ , 5%, 1/4W	02-2139	09021	CF 1/4 100K J
1.A2.R35	Res VAR, 100K $\Omega$ 25%	02-1026	51406	RVS0707V-100-3-104
1.A2.R36	Res CF, 2.7 $\Omega$ , 5%, 1/4W	02-2165	09021	CF 1/4 2.7 J
1.A2.R37	Res CF, 0.47 $\Omega$ , 5%, 1/2W	02-2230	09021	CF 1/2 .47 J
1.A2.R38	Res CF, 0.47 $\Omega$ , 5%, 1/2W	02-2230	09021	CF 1/2 .47 J
1.A2.R39	Res MF, 499K $\Omega$ , 1%, 1/4W	02-2197	09021	MF55D4993F
1.A2.R40	Res MF, 86.6K $\Omega$ , 1%, 1/4W	02-2136	09021	MF55D8662F
1.A2.R41	Res MF, 28.0K $\Omega$ , 1%, 1/4W	02-2191	09021	MF55D2802F
1.A2.R42	Res MF, 1.21K $\Omega$ , 1%, 1/4W	02-2192	09021	MF55D1211F
1.A2.R43	Res CF, 36.5 $\Omega$ , 1%, 1W	02-2231	09021	CF 1 36.5 J
1.A2.R44	Res MF, 20.0K $\Omega$ , 1%, 1/4W	02-2188	09021	MF55D2002F
1.A2.R45	Res MF, 86.6K $\Omega$ , 1%, 1/4W	02-2136	09021	MF55D8662F
1.A2.R46	Res MF, 28.0K $\Omega$ , 1%, 1/4W	02-2191	09021	MF55D2802F
1.A2.R47	Res MF, 499K $\Omega$ , 1%, 1/4W	02-2197	09021	MF55D4993F

LIST OF REPLACEABLE PARTS

SIGNAL PCB ASSEMBLY PARTS LIST (con't)

REF DES	DESCRIPTION	HUNTRON P/N	FSCM	MANUFACTURERS PART NUMBER
1.A2.R48	Res MF, 16.2KΩ, 1%, 1/4W	02-2232	09021	MF55D1622F
1.A2.R49	Res VAR, 10KΩ, 25%	02-1044	51406	RVS0707V-100-3-103
1.A2.R50	Res VAR, 10KΩ, 25%	02-1044	51406	RVS0707V-100-3-103
1.A2.R51	Res MF, 16.2KΩ, 1%, 1/4W	02-2232	09021	MF55D1622F
1.A2.R52	Res MF, 20.0KΩ, 1%, 1/4W	02-2188	09021	MF55D2002F
1.A2.R53	Res VAR, 100KΩ 25%	02-1026	51406	RVS0707V-100-3-104
1.A2.R54	Res CF, 4.7KΩ, 5%, 1/4W	02-2145	09021	CF 1/4 4.7K J
1.A2.R55	Res MF, 2.49KΩ, 1%, 1/4W	02-2198	09021	MF55D2491F
1.A2.R56	Res MF, 10.0Ω, 1%, 1/4W	02-2194	09021	MF55D10R0F
1.A2.R57	Res MF, 7.50KΩ, 1%, 1/4W	02-2199	09021	MF55D7501F
1.A2.R58	Res MF, 10.0KΩ, 1%, 1/4W	02-2189	09021	MF55D1002F
1.A2.R59	Res MF, 18.7KΩ, 1%, 1/4W	02-2237	09021	MF55D1872F
1.A2.R60	Res VAR, 20KΩ, 25%	02-1032	51406	RVS0707V-100-3-203
1.A2.R61	Res MF, 7.5KΩ, 1%, 1/4W	02-2199	09021	MF55D7502F
1.A2.R62	Res MF, 2.49KΩ, 1%, 1/4W	02-2198	09021	MF55D2491F
1.A2.R63	Res MF, 10.0Ω, 1%, 1/4W	02-2194	09021	MF55D10R0F
1.A2.R64	Res MF, 7.50KΩ, 1%, 1/4W	02-2199	09021	MF55D7501F
1.A2.R65	Res MF, 10.0KΩ, 1%, 1/4W	02-2189	09021	MF55D1002F
1.A2.R66	Res MF, 15.0KΩ, 1%, 1/4W	02-2200	09021	MF55D1502F
1.A2.T1	Transformer, Signal	06-6034	57705	06-6034
1.A2.U1	* IC, Dual J-K Flip Flop	05-5024	27014	CD4027B
1.A2.U2	IC, Op Amp	05-5034	27014	LF351N
1.A2.U3	IC, Oscillator	05-5036	52063	XR2209CP
1.A2.U4	IC, Oscillator	05-5036	52063	XR2209CP
1.A2.U5	* IC, 3P2T Analog Switch	05-5042	27014	CD4053B
1.A2.U6	IC, Dual Op Amp	05-5035	27014	LF353N
1.A2.U7	IC, Power Op Amp	05-5019	07263	uA759
1.A2.U8	IC, Power Op Amp	05-5019	07263	uA759
1.A2.U9	IC, Dual Op Amp	05-5043	27014	LF412CN
1.A2.U10	IC, Dual Op Amp	05-5043	27014	LF412CN
1.A2.U11	* IC, 2P4T Analog Switch	05-5020	27014	CD4052B
1.A2.U12	IC, Dual Op Amp	05-5043	27014	LF412CN
1.A2.U13	* IC, 2P4T Analog Switch	05-5020	27014	CD4052B

FRONT CONTROL ASSEMBLY PARTS LIST

REF DES	DESCRIPTION	HUNTRON P/N	FSCM	MANUFACTURERS PART NUMBER
1.A3	Front Control Assembly	06-1058	57705	06-1058
1.A3.A1	Control PCB Assembly	06-3043	57705	06-3043
1.A3.MP1	Button, Switch, Dark Gray (2)	07-2082	N/A	TZ 2210
1.A3.MP2	Button, Switch, Light Gray (13)	07-2083	N/A	TZ 2211
1.A3.MP3	Screw, Philips P.H., 1/4" 4-40 (8)	07-3050	73734	19024
1.A3.MP4	Graticule	01-2003	57705	01-2003
1.A3.MP5	Lens Gasket, (2)	01-1067	57705	01-1067
1.A3.MP6	Lens Gasket, (2)	01-1066	57705	01-1066
1.A3.MP7	Banana Jack, Red	07-1147	83330	1509-102
1.A3.MP8	Banana Jack, Black	07-1148	83330	1509-103
1.A3.MP9	Banana Jack, Yellow	07-1149	83330	1509-107
1.A3.MP10	Banana Jack, Blue (2)	07-1152	83330	1509-105

## LIST OF REPLACEABLE PARTS

## CONTROL PCB ASSEMBLY PARTS LIST (refer to Figure 5-2)

REF DES	DESCRIPTION	HUNTRON P/N	FSCM	MANUFACTURES PART NUMBER
1.A3.A1	Control PCB Assembly	06-3043	57705	06-3043
1.A3.A1.MP1	PCB, Control	07-7717	57705	07-7717
1.A3.A1.P1	Not Used			
1.A3.A1.P2	Not Used			
1.A3.A1.P3	Not Used			
1.A3.A1.P4	Not Used			
1.A3.A1.P5	Not Used			
1.A3.A1.P6	Connector, Male, Dual Row, 22 pin	07-1184	91662	008251-044-000-021
1.A3.A1.R1	Pot, Control, 1K $\Omega$	02-1028	12697	388N 1K
1.A3.A1.R2	Pot, Control, 1K $\Omega$	02-1028	12697	388N 1K
1.A3.A1.R3	Res VAR, 10K $\Omega$	02-1038	32997	3386Y-1-103
1.A3.A1.R4	Not Used			
1.A3.A1.R5	Res CF, 47K $\Omega$ , 5%, 1/4W	02-2143	09021	CF 1/4 47K J
1.A3.A1.R6	Pot, Control, 50K $\Omega$	02-1027	12697	388N 50K
1.A3.A1.R7	Pot, Control, 1M	02-1029	12697	388N 1M
1.A3.A1.R8	Pot, Control, 1M, Rev. Z Taper	02-1034	12697	388NRZ 1M
1.A3.A1.S1	Switch, Push Button, W/LED (Red)	07-4023	N/A	TR2-01-L2
1.A3.A1.S2	Switch, Push Button, W/LED (Green)	07-4024	N/A	TR2-01-L5
1.A3.A1.S3	Switch, Push Button, W/LED (Green)	07-4024	N/A	TR2-01-L5
1.A3.A1.S4	Switch, Push Button, W/LED (Green)	07-4024	N/A	TR2-01-L5
1.A3.A1.S5	Switch, Push Button, W/LED (Green)	07-4024	N/A	TR2-01-L5
1.A3.A1.S6	Switch, Push Button, W/LED (Yellow)	07-4025	N/A	TR2-01-L8
1.A3.A1.S7	Switch, Push Button, W/LED (Yellow)	07-4025	N/A	TR2-01-L8
1.A3.A1.S8	Switch, Push Button, W/LED (Yellow)	07-4025	N/A	TR2-01-L8
1.A3.A1.S9	Switch, Push Button, W/LED (Yellow)	07-4025	N/A	TR2-01-L8
1.A3.A1.S10	Switch, Push Button, W/LED (Green)	07-4024	N/A	TR2-01-L5
1.A3.A1.S11	Switch, Push Button, W/LED (Green)	07-4024	N/A	TR2-01-L5
1.A3.A1.S12	Switch, Push Button, W/LED (Yellow)	07-4025	N/A	TR2-01-L8
1.A3.A1.S13	Switch, Push Button, W/LED (Red)	07-4023	N/A	TR2-01-L2
1.A3.A1.S14	Switch, Push Button, W/LED (Green)	07-4024	N/A	TR2-01-L5
1.A3.A1.S15	Switch, Push Button, W/LED (Yellow)	07-4025	N/A	TR2-01-L8

## CRT ASSEMBLY PARTS LIST (refer to Figure 5-3)

REF DES	DESCRIPTION	HUNTRON P/N	FSCM	MANUFACTURES PART NUMBER
1.A4	CRT Assembly	06-2062	57705	06-2062
1.A4.MP1	Shield	06-2044	57705	06-2044
1.A4.MP2	CRT, Toshiba	07-4018	N/A	85 DB31
1.A4.MP3	Rotation Coil	06-6056	57705	06-6056
1.A4.MP4	Harness Assembly	06-4012	57705	06-4012

**LIST OF REPLACEABLE PARTS**

**Notes:**

# SECTION 6

## SCHEMATIC DIAGRAMS

### 6-1. SCHEMATICS

The following list shows the component location diagrams and schematic diagrams for the 2000.

Figure No.	Title	Page
6-1	Main PCB Component Locations .....	6-2
6-2	Main PCB Schematic .....	6-4
6-3	Signal PCB Component Locations .....	6-6
6-4	Signal PCB Schematic .....	6-7
6-5	Control PCB Component Locations .....	6-8
6-6	Control PCB Schematic .....	6-9

**SCHEMATIC DIAGRAMS**

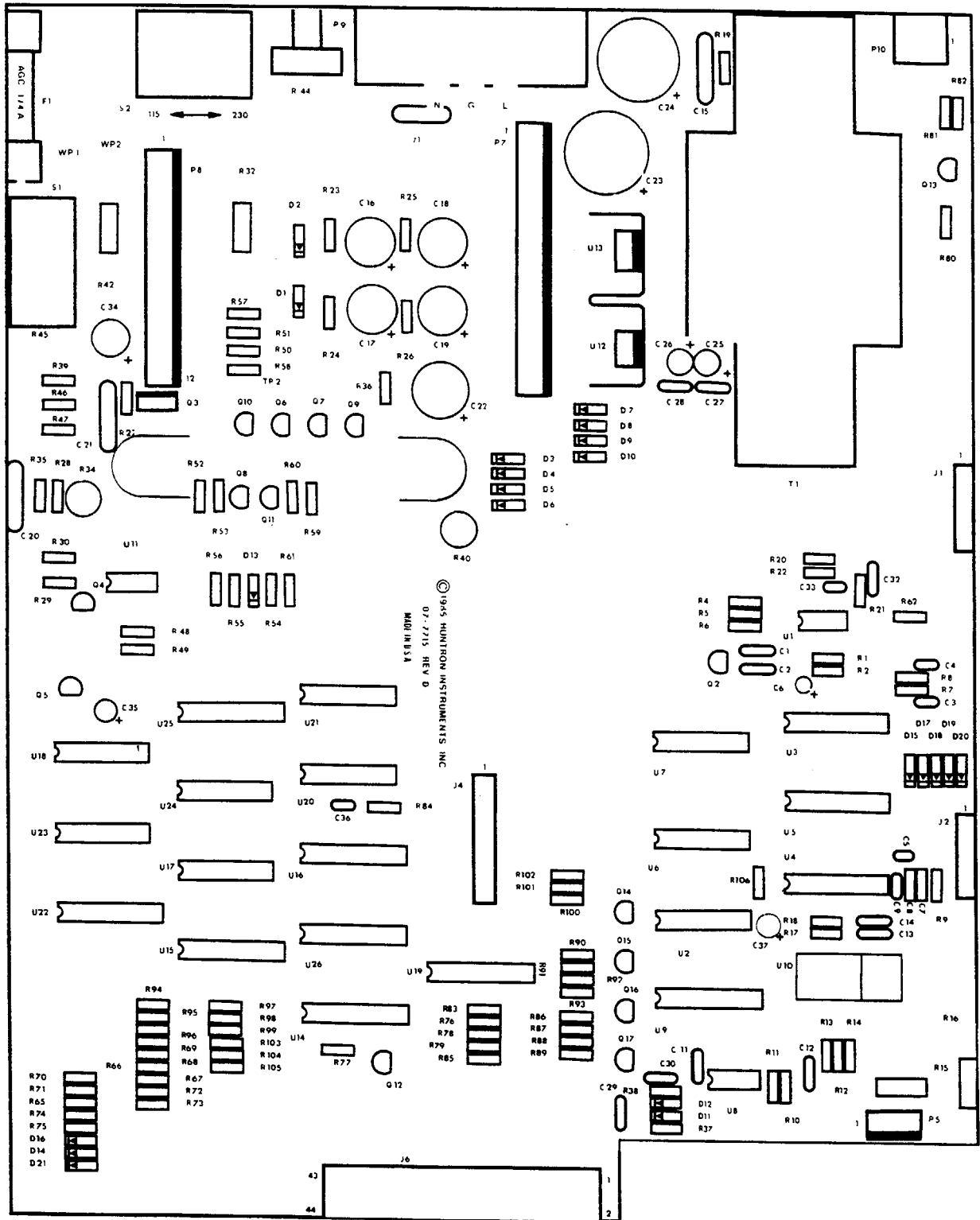

**Figure 6-1. Main PCB Component Locations**

**This page intentionally left blank.**



SCHEMATIC DIAGRAMS

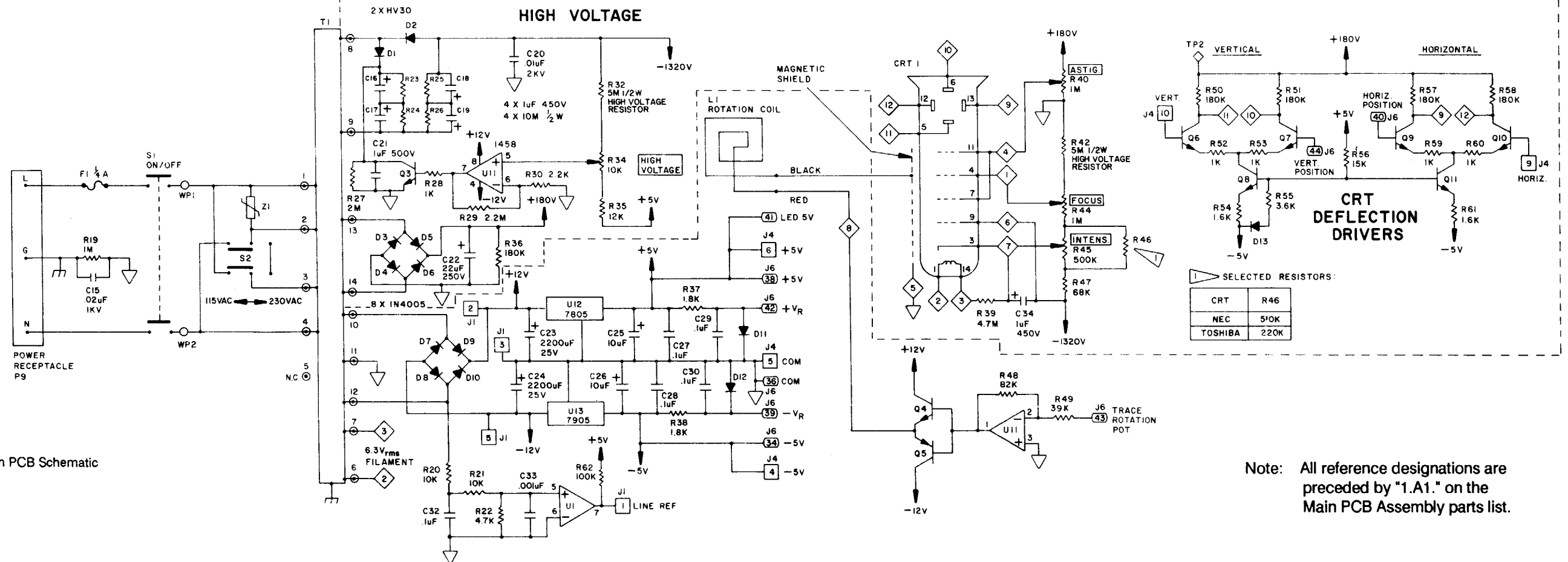
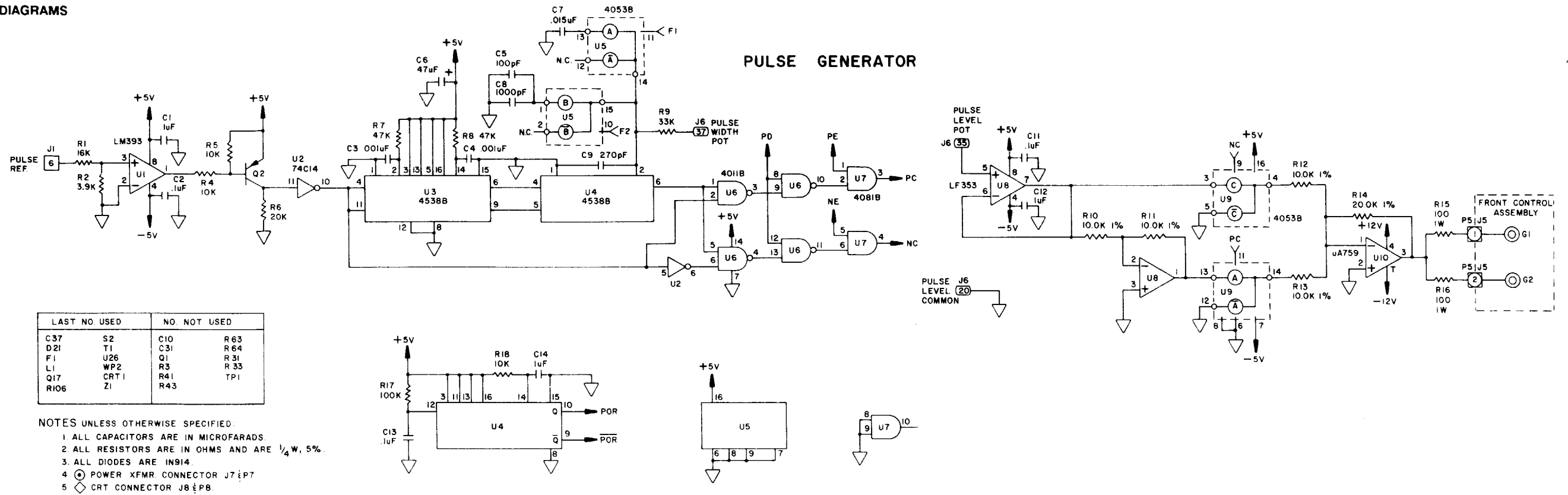

Figure 6-2. Main PCB Schematic

Note: All reference designations are preceded by "1.A1." on the Main PCB Assembly parts list.

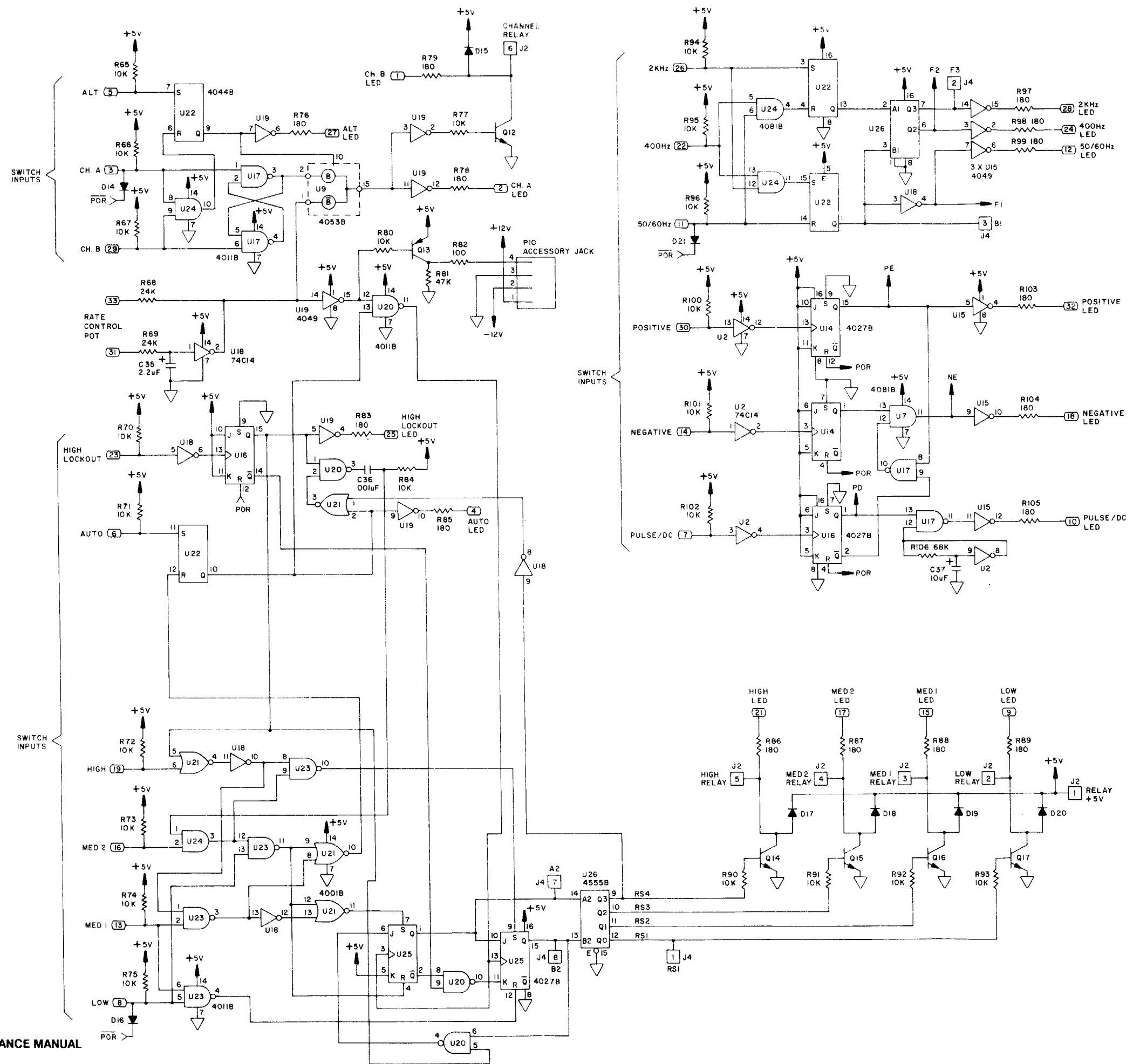

Figure 6-2

SCHEMATIC DIAGRAMS

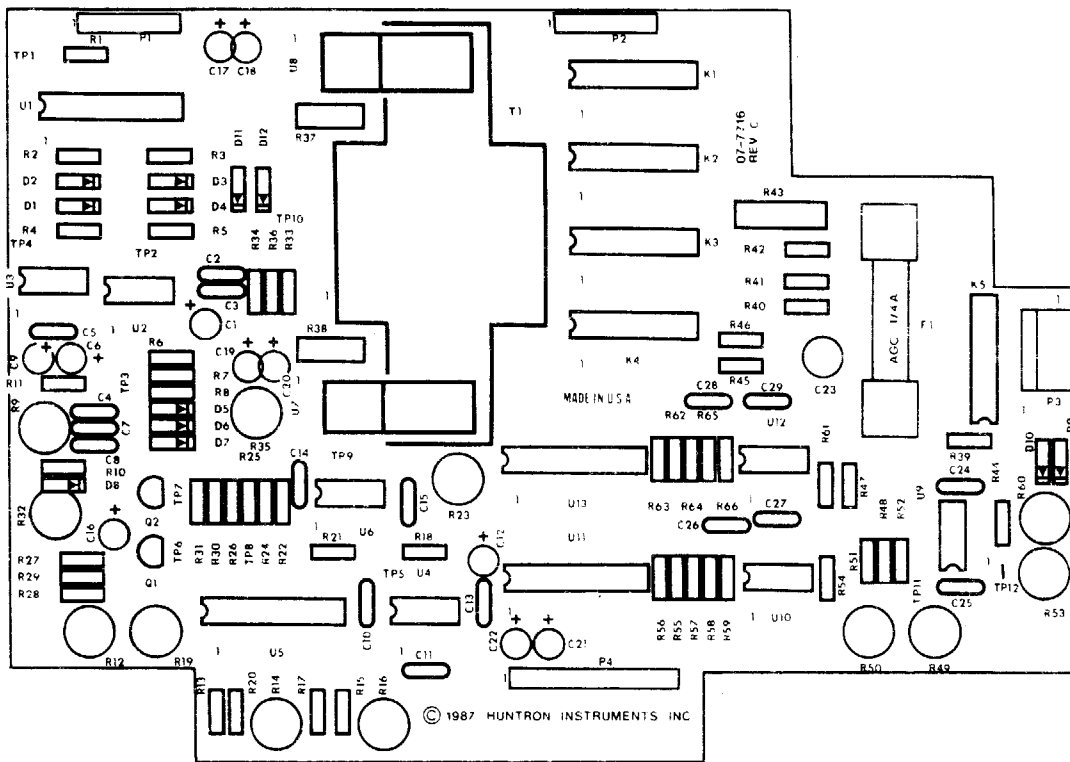
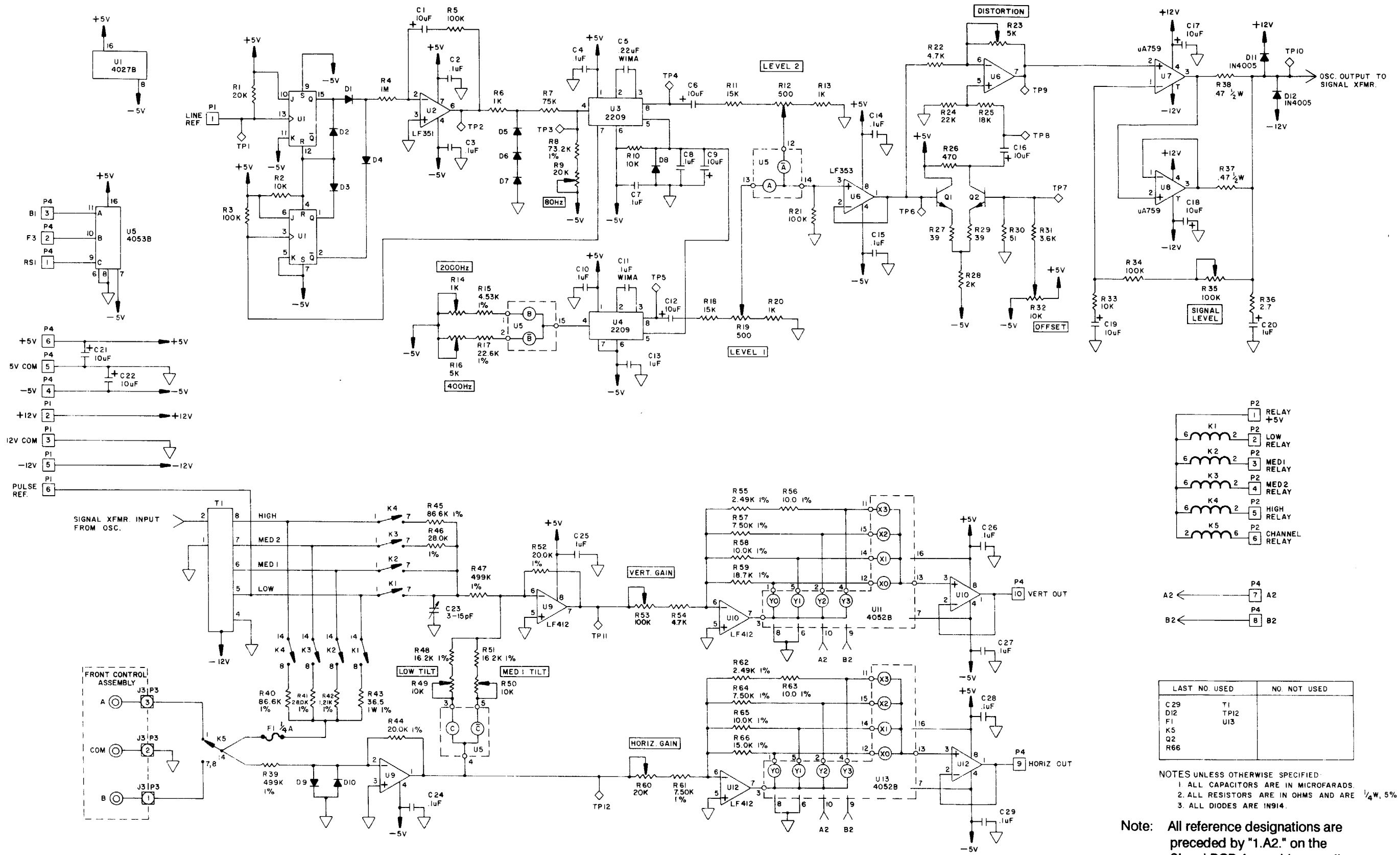
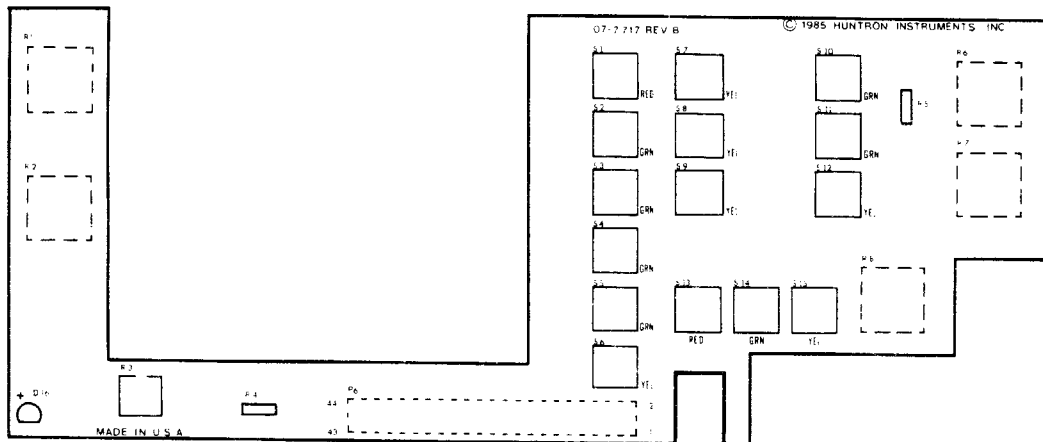

Figure 6-3. Signal PCB Component Locations



**SCHEMATIC DIAGRAMS**



**Figure 6-5. Control PCB Component Locations**

**SCHEMATIC DIAGRAMS**

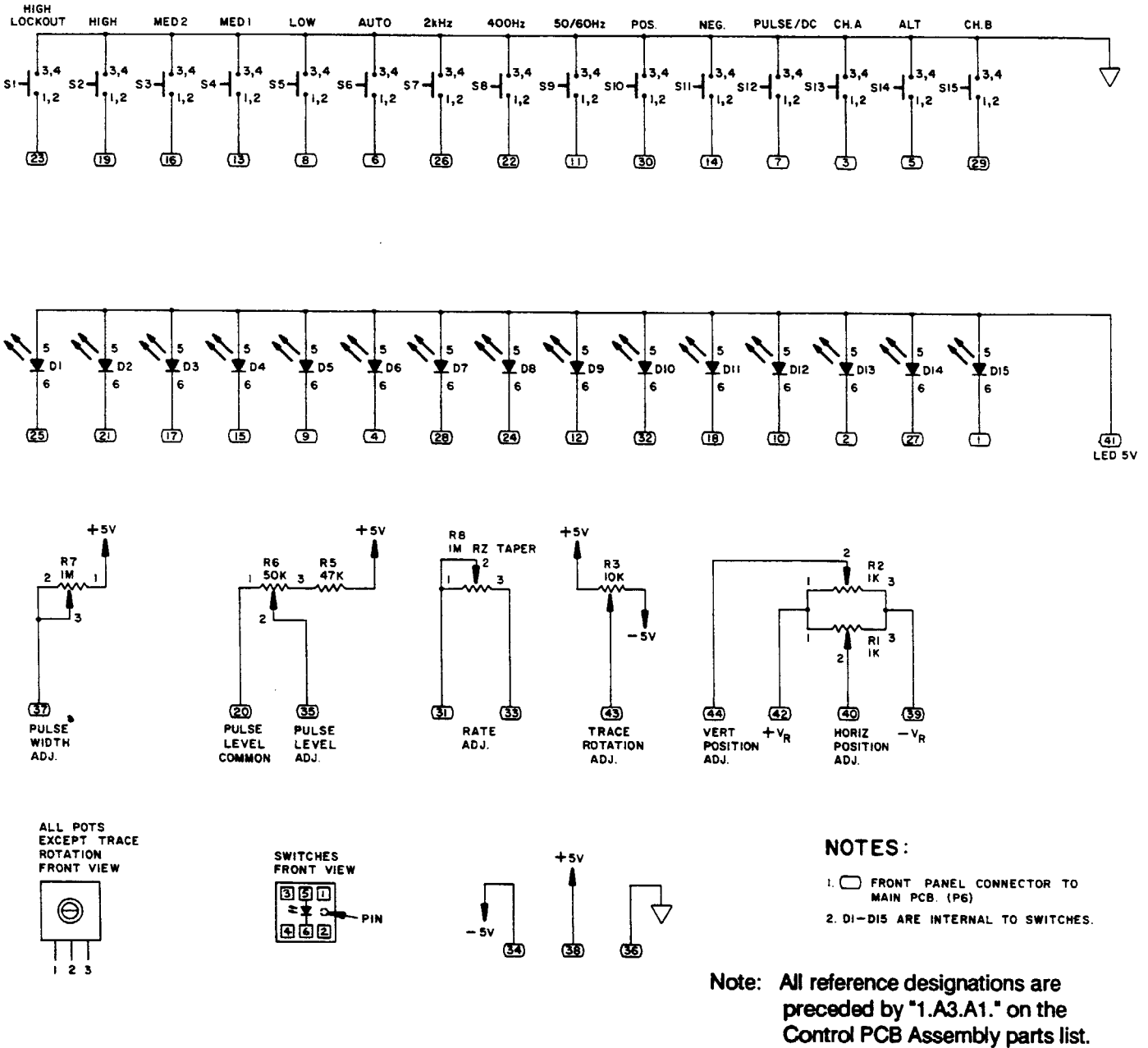

Figure 6-6. Control PCB Schematics

**Table 6-1**  
**DC Resistance of Coils and Transformers\***

1.T1 (T1 on Main PCB schematic)		
Pin Numbers	DC Resistance $\pm 20\%$	
1-2	175	
3-4	175	
6-7	1	
8-9	2765	
10-11	2	
11-12	2	
13-14	565	
1.A2.T1 (T1 on Signal PCB schematic)		
Pin Numbers	DC Resistance $\pm 20\%$	
1-2	1	
4-5	4	
5-6	2	
6-7	21	
7-8	178	
1.A2.K1 - 1.A2.K5 (K1 - K5 on Signal PCB schematic)		
Pin Numbers	DC Resistance	
	min	max
2-6	100	250

\* all resistance values are in ohms.

**Table 6-2**  
**Pulse Generator Terminal Wiring Harness<sup>1</sup>**

PIN NO	COLOR	DESCRIPTION
1	BLUE	GATE 1
2	BLUE	GATE 2

<sup>1</sup> This harness mates with 1.A1.P5.

**Table 6-3**  
**Test Terminal Wiring Harness<sup>2</sup>**

PIN NO	COLOR	DESCRIPTION
1	YELLOW	B INPUT
2	BLACK	COMMON
3	RED	A INPUT

<sup>2</sup> This harness mates with 1.A2.P3.



**Table 6-4**  
**CRT Assembly Wiring Harness<sup>3</sup>**

PIN NO	COLOR	DESCRIPTION
1	WHITE/GREEN	FOCUS
2	WHITE/VIOLET	FILAMENT SUPPLY
3	WHITE/BLUE	FILAMENT SUPPLY
4	WHITE/YELLOW	ASTIGMATISM
5	BLACK	GROUND
6	WHITE	-1320 VDC
7	WHITE/BROWN	INTENSITY
8	RED	ROTATION
9	WHITE/BLACK	HORIZ. DEFLECTION
10	BROWN	VERT. DEFLECTION
11	WHITE/RED	VERT. DEFLECTION
12	ORANGE	HORIZ. DEFLECTION

<sup>3</sup> This harness mates with 1.A1.P8

**Table 6-5**  
**Power Transformer Assembly Wiring Harness<sup>4</sup>**

PIN NO	COLOR	DESCRIPTION
1	BLACK	AC INPUT
2	BROWN	AC INPUT
3	RED	AC INPUT
4	YELLOW	AC INPUT
5	-	NOT USED
6	PINK/YEL	6.3 V <sub>rms</sub>
7	PINK/YEL	6.3 V <sub>rms</sub>
8	PINK/GRN	HV
9	PINK/GRN	HV
10	WHITE	18 V <sub>rms</sub>
11	WHITE/RED	CENTER TAP
12	WHITE	18 V <sub>rms</sub>
13	GRAY	130 V <sub>rms</sub>
14	GRAY	130 V <sub>rms</sub>

<sup>4</sup> This harness mates with 1.A1.P7.

# SECTION 7 RESISTORS, CAPACITORS AND INDUCTORS

## 7-1. TESTING RESISTORS

A pure resistance across the test probes will cause the trace on the 2000 display to rotate in a counterclockwise direction around its center axis from an open circuit position. The degree of rotation is a function of the resistance value.

## 7-2. Low Range

The low range is designed to detect resistance between  $1\Omega$  and  $1K\Omega$ . Figure 7-1 shows the effect of resistance on the angle of rotation in low range. A  $1\Omega$  resistor causes almost 90 degrees of rotation, and a  $50\Omega$  resistor produces a 45 degree rotation. A  $400\Omega$  resistor causes a small rotation in angle. Resistors lower than  $1\Omega$  appear as a short circuit (i.e., vertical trace) and resistance values above  $400\Omega$  look like open circuits (i.e., horizontal trace).

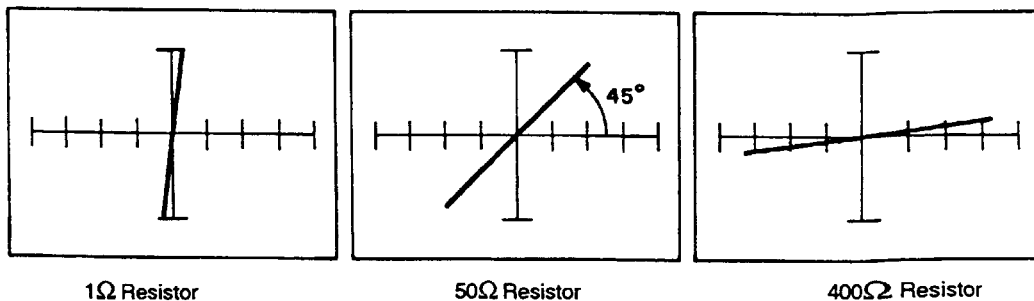

Figure 7-1. Effects of Resistance on the Rotation Angle - Low Range.

### 7-3. Medium 1 Range

The medium 1 range is designed to detect resistance between  $50\Omega$  and  $10K\Omega$ . Figure 7-2 shows the signatures for a  $50\Omega$  resistor, a  $1K\Omega$  resistor, and a  $10K\Omega$  resistor using the medium 1 range. Resistors that are smaller than  $50\Omega$  appear almost as a vertical line. A  $1K\Omega$  resistor causes an angle of rotation of 45 degrees, while the display for a  $10K\Omega$  resistor shows only slight rotation. Resistance values higher than  $10K\Omega$  produce such a small rotation angle that it appears almost as a horizontal line.

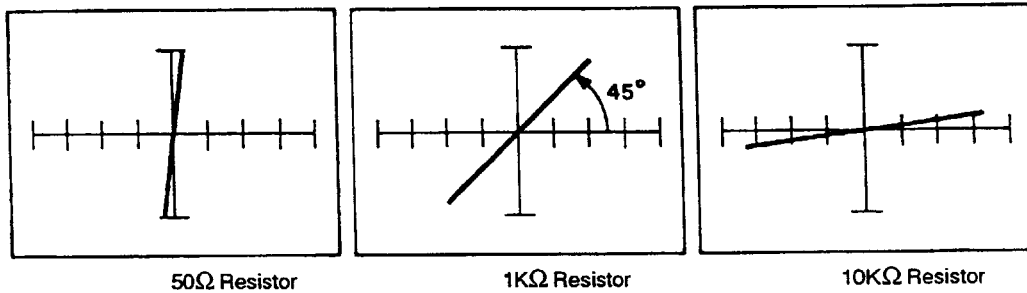

Figure 7-2. Effects of Resistance on the Rotation Angle - Medium 1 Range.

### 7-4. Medium 2 Range

The medium 2 range is designed to detect resistance between  $1K\Omega$  and  $200K\Omega$ . Figure 7-3 shows the signatures for a  $1K\Omega$  resistor, a  $15K\Omega$  resistor, and a  $200K\Omega$  resistor using the medium 2 range. Resistance values smaller than  $1K\Omega$  appear almost as a vertical line. A  $15K\Omega$  resistor causes an angle of rotation of 45 degrees, while the display for a  $200K\Omega$  resistor shows only slight rotation. Resistors higher than  $200K\Omega$  produce such a small rotation angle that it appears almost as a horizontal line.

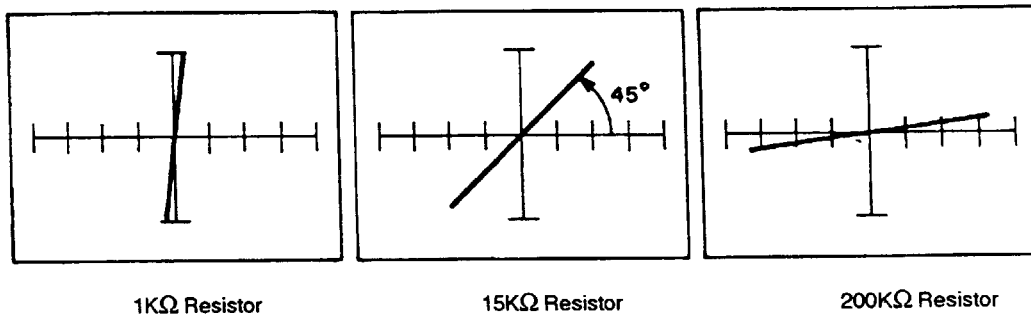

Figure 7-3. Effect of Resistance on the Rotation Angle - Medium 2 Range.

### 7-5. High Range

The high range is designed to detect resistance between 3KΩ and 1MΩ. Figure 7-4 shows the signatures for a 3KΩ resistor, a 50KΩ resistor, and a 1MΩ resistor using the high range. Resistors that are smaller than 3KΩ appear almost as a vertical line. A 50KΩ resistor causes an angle of rotation of 45 degrees, while the display for a 1MΩ resistor shows only slight rotation. Resistance values higher than 1MΩ produce such a small rotation angle that it appears almost as a horizontal line.

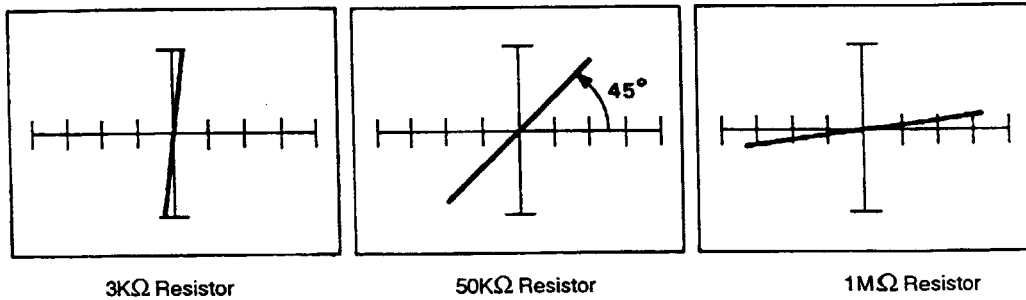

Figure 7-4. Effects of Resistance on the Rotation Angle-High Range.

### 7-6. TESTING CAPACITORS

With a capacitor connected to the 2000, the voltage,  $V(t)$ , across the capacitor is given as:

$$V(t) = A \sin (\omega t) \dots\dots\dots (1)$$

The current in the loop,  $I(t)$ , is 90 degrees out of phase with respect to the voltage and is given as:

$$I(t) = B \cos (\omega t) \dots\dots\dots (2)$$

where A and B are constants, and  $\omega$  is the test signal frequency in radians/sec.

From equation (1):

$$V(t)/A = \sin (\omega t)$$

or

$$V^2(t)/A^2 = \sin^2 (\omega t) \dots\dots\dots (3)$$

From equation (2):

$$I(t)/B = \cos (\omega t)$$

or

$$I^2(t)/B^2 = \cos^2 (\omega t) \dots\dots\dots (4)$$

Adding equations (3) and (4):

$$V^2(t)/A^2 + I^2(t)/B^2 = \sin^2 (\omega t) + \cos^2 (\omega t) = 1 \dots\dots\dots (5)$$

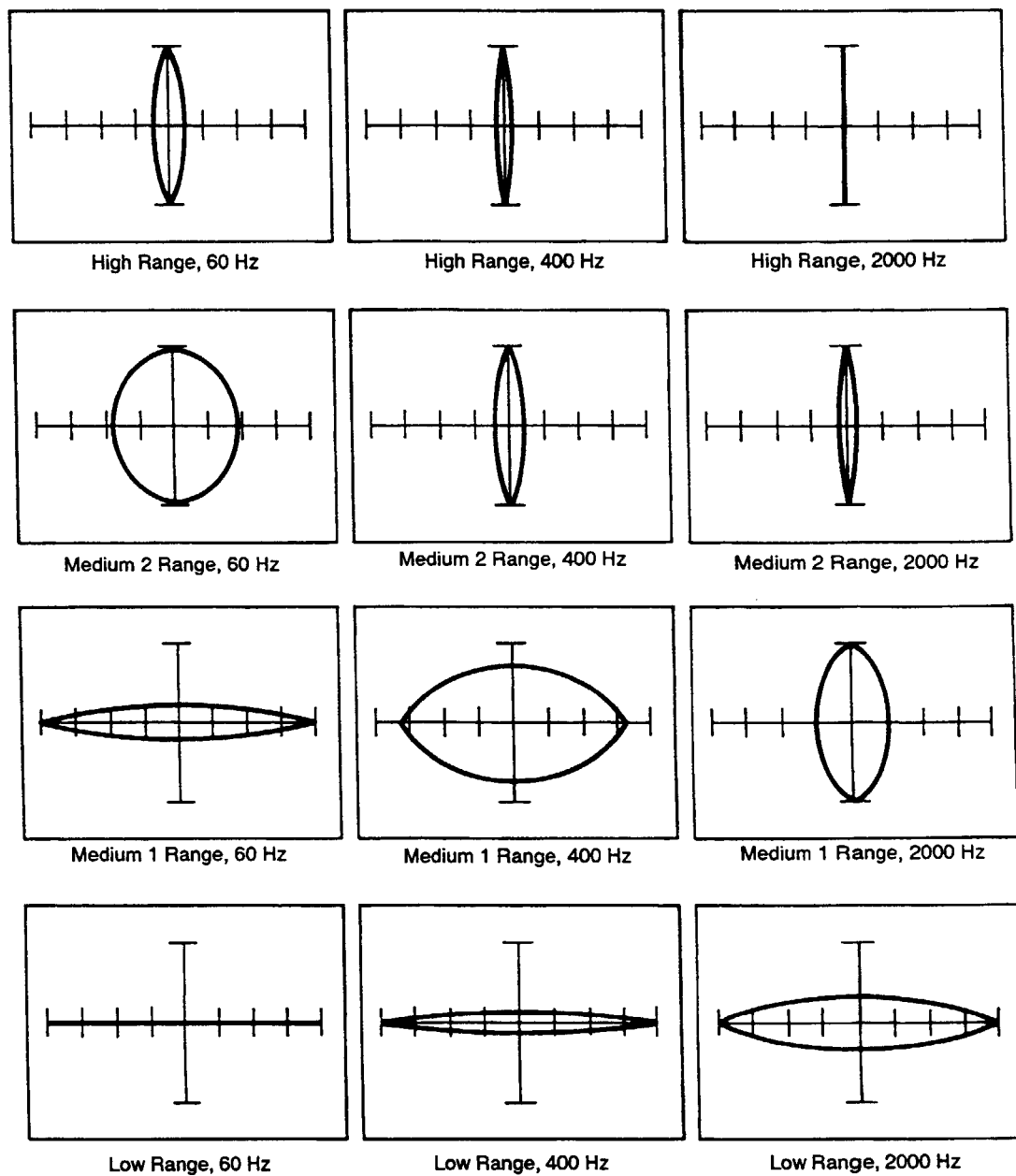

Figure 7-5. Signatures of a 0.22µF Capacitor.

This is the equation of an ellipse. It becomes a circle if  $A = B$ . The size and shape of the ellipse depends on the capacitor value, test signal frequency, and the selected impedance range.

Figure 7-5 shows the signatures of a  $0.22\mu\text{F}$  capacitor in each of the twelve combinations of range and frequency. Note that this value of capacitance appears to be an open circuit in the low range at 60 Hz, while in the high range at 2000 Hz this value is equivalent to a short circuit. In between the extremes this capacitor produces a variety of ellipsoids which demonstrates that certain range and frequency combinations are better than others for examining this particular value. Table 7-1 lists the range of capacitance covered by each of the twelve range and frequency combinations. The lowest value of capacitance in each combination gives a narrow horizontal ellipsoid on the display and capacitors less than the lower bound look like an open circuit. The upper bound of capacitance will produce a narrow vertical ellipsoid with capacitors of greater value appearing as the vertical line signature of a short circuit.

**Table 7-1**  
**Min/Max Capacitance Values**

RANGE	TEST FREQUENCY		
	50/60	400 Hz	2000 Hz
HIGH	.001 $\mu\text{F}$ -1 $\mu\text{F}$	500pF-.1 $\mu\text{F}$	100pF-.02 $\mu\text{F}$
MEDIUM 2	.01 $\mu\text{F}$ -2 $\mu\text{F}$	.001 $\mu\text{F}$ -.5 $\mu\text{F}$	200pF-.05 $\mu\text{F}$
MEDIUM 1	.2 $\mu\text{F}$ -50 $\mu\text{F}$	.02 $\mu\text{F}$ -5 $\mu\text{F}$	.005 $\mu\text{F}$ -1 $\mu\text{F}$
LOW	5 $\mu\text{F}$ -2000 $\mu\text{F}$	.5 $\mu\text{F}$ -100 $\mu\text{F}$	.2 $\mu\text{F}$ -25 $\mu\text{F}$

## 7-7. TESTING INDUCTORS

Inductors, like capacitors, produce elliptical signatures on the 2000 display. Figure 7-6 shows the signatures produced in each of the twelve range and frequency combinations by a 250mH inductor.

RESISTORS, CAPACITORS AND INDUCTORS

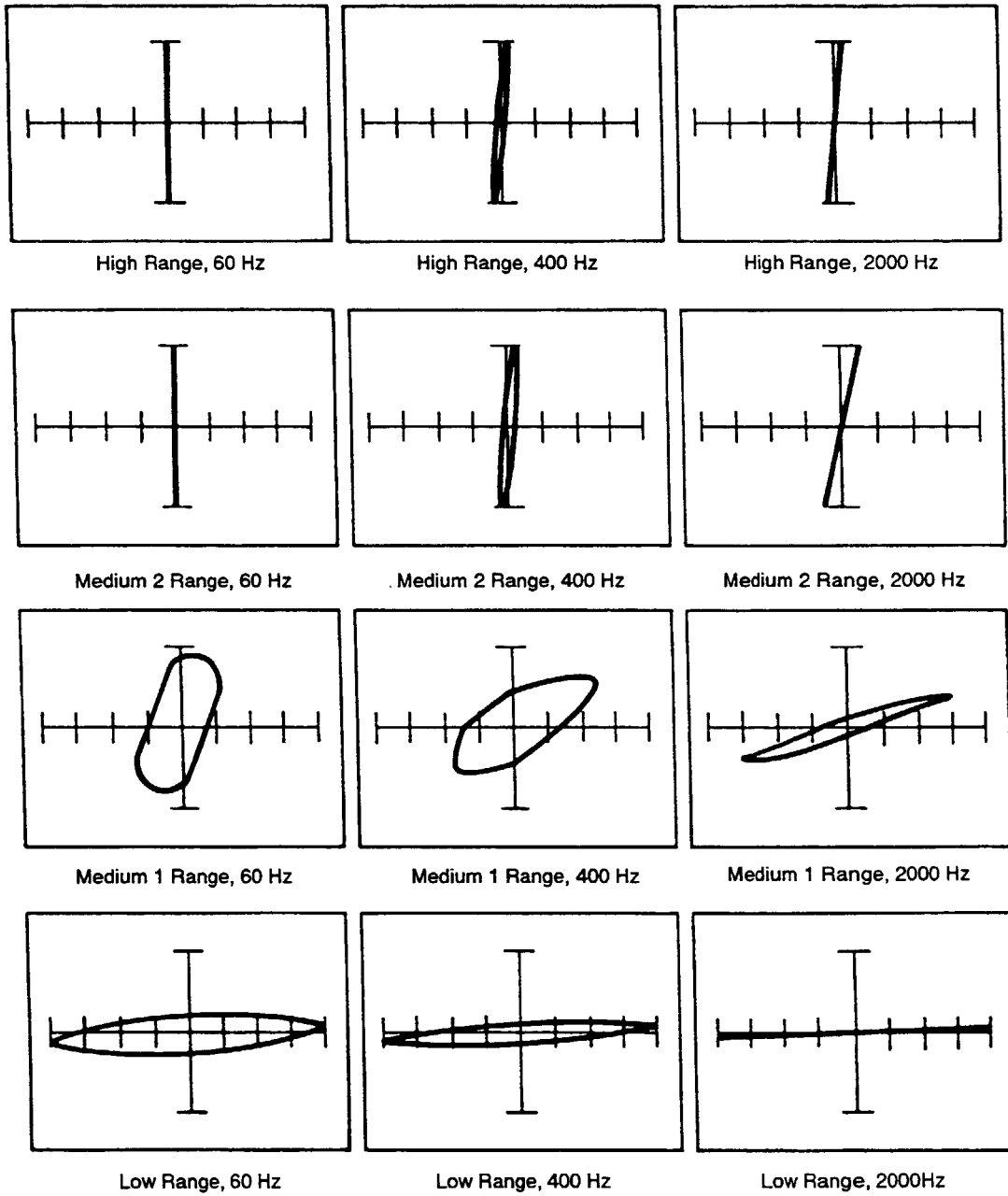

Figure 7-6. Signatures of a 250mH Inductor.



## 7-8. TESTING FERRITE INDUCTORS

Ferrite inductors can be checked with the 2000, but produce a signature that differs from the previously described inductor. Ferrite inductors operate well at high frequencies, but saturate at low frequencies. Figure 7-7 shows the signatures of a 490mH ferrite inductor tested at 60 Hz. In low and medium 1 range the signatures show distortion. However, in medium 2 and high range, the impedance of the inductor is low compared with the internal impedance of the 2000 so the signatures are a "split" vertical trace. Figures 7-8 and 7-9 show the signatures of ferrite inductor at 400 Hz and 2000 Hz respectively.

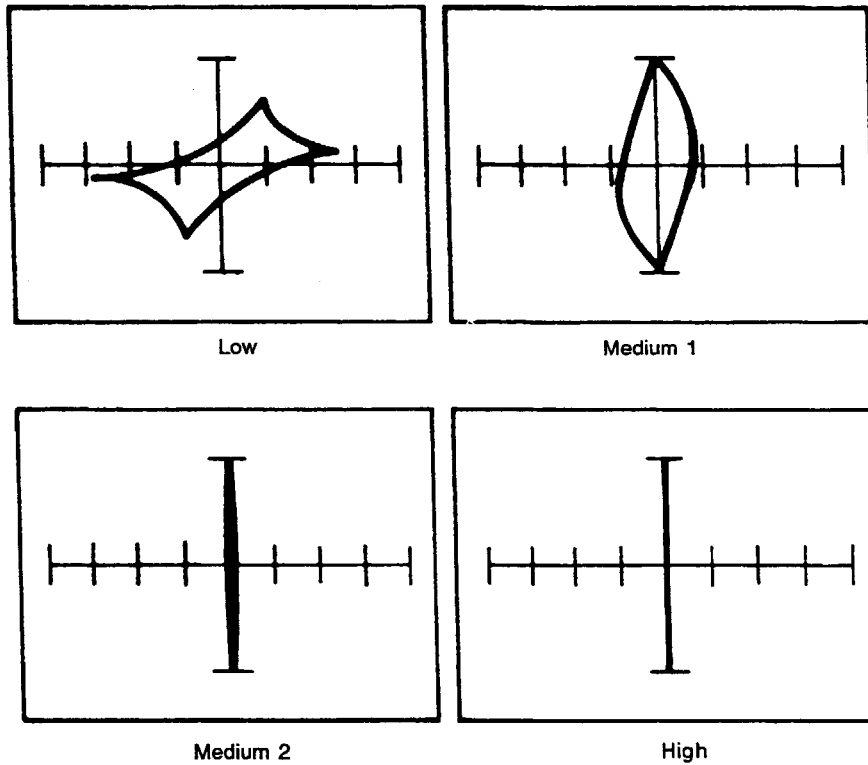

Figure 7-7. Signatures of a 490mH Ferrite Inductor Tested at 60 Hz.

RESISTORS, CAPACITORS AND INDUCTORS

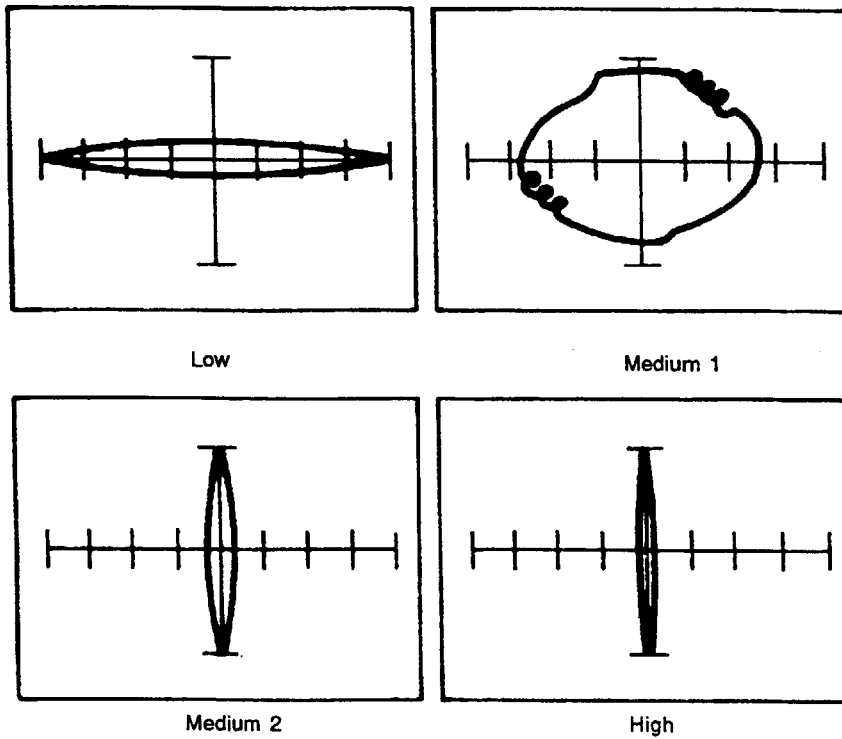

Figure 7-8. Signatures of 490mH Ferrite Inductor at 400 Hz.

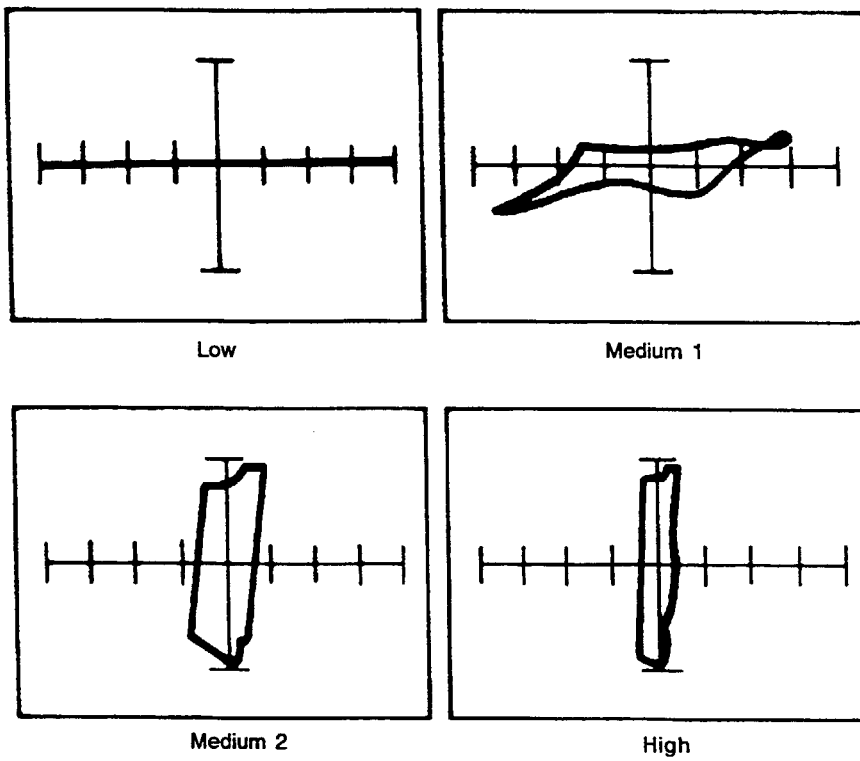

Figure 7-9. Signatures of a 490mH Ferrite Inductor at 2000 Hz.

# SECTION 8

## TESTING DIODES

### 8-1. THE SEMICONDUCTOR DIODE AND ITS CHARACTERISTICS

#### 8-2. Diode Symbol and Definition

A semiconductor diode is formed by the creation of a junction between P-material and N-material within a crystal during the manufacturing process. The standard semiconductor diode has in its symbol an arrow to indicate the direction of forward current flow, as shown in Figure 8-1. With positive voltage applied to the P-material and negative voltage applied to the N-material, the diode is said to be forward biased, as shown in Figure 8-2. The current ( $I_f$ ) increases rapidly with small increases in applied voltage ( $V$ ).

When the applied voltage is reversed, the P-material is negative with respect to the N-material and very small levels of current flow through the diode. The small current ( $I_o$ ) is the diode "reverse saturation current", and its magnitude increases with temperature. In practice,  $I_o$  can be ignored.

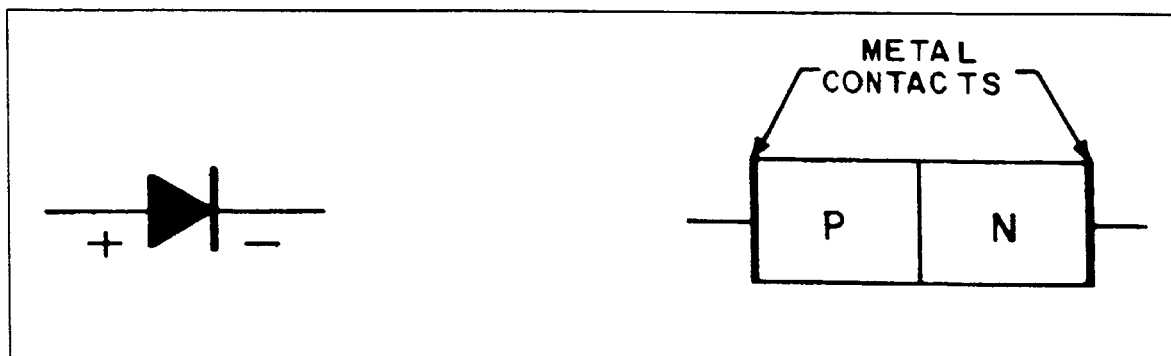

Figure 8-1. Diode Symbol.

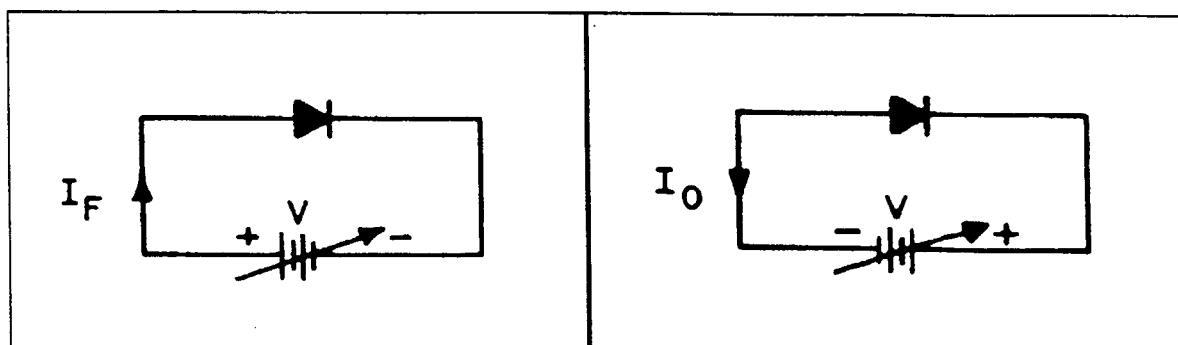

Figure 8-2.  
P-N Junction Biased in the Forward Direction.

Figure 8-3.  
P-N Junction Biased in the Reverse Direction.

### 8-3. The Volt-Ampere Characteristic

For a P-N junction, the current (I) is related to the voltage (V) by the following equation:

$$I = I_0 (\exp (kV) - 1)$$

Where k is a constant depending on the temperature and material. The volt-ampere characteristic described by the equation above is shown in Figure 8-4. For the sake of clarity, the current ( $I_0$ ) has been greatly exaggerated in magnitude. The dashed portion of the curve in Figure 8-4 indicates that, at a certain reverse voltage ( $V_{br}$ ), the diode characteristic exhibits an abrupt and marked departure from the equation above. At this critical voltage, a large reverse current flows and the diode is said to be in the breakdown region.

A good diode has very large reverse biased resistance and small forward biased resistance. The forward junction voltage drop ( $V_f$ ) is between 0.5 Volts and 2.8 Volts depending on the semiconductor material. For example,  $V_f$  is 0.6 Volts for a silicon diode, whereas  $V_f$  is 1.5 Volts for a typical light-emitting diode. The 2000 can visually display all these parameters.

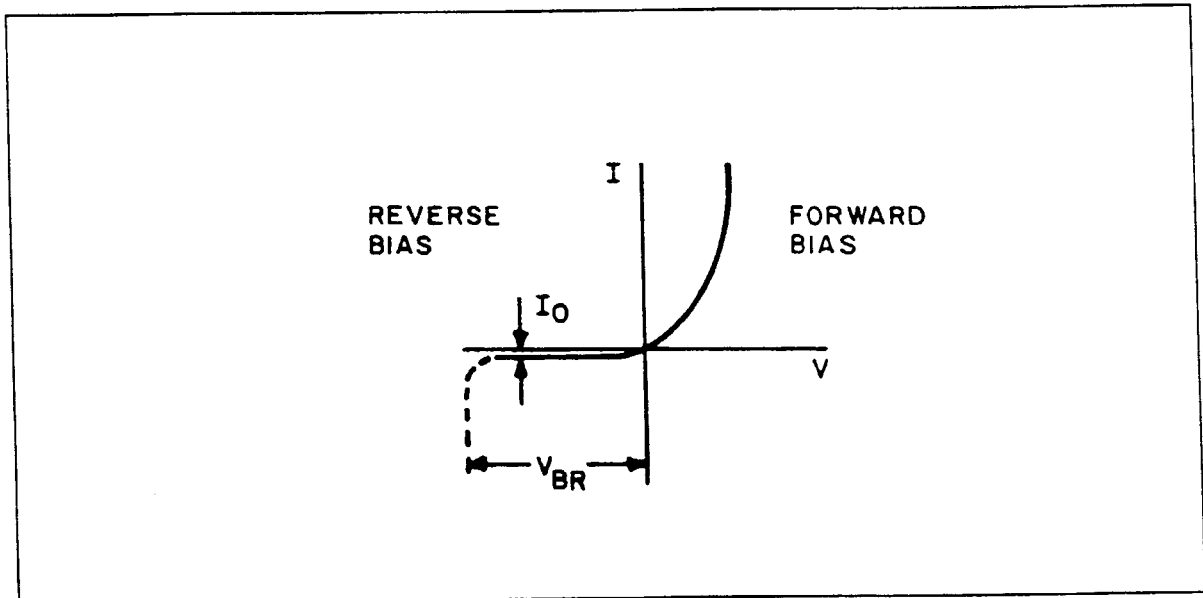

Figure 8-4. The Volt-Ampere Characteristic of a Semiconductor Diode.

### 8-4. SILICON DIODES

### 8-5. Signatures Of A Good Diode

Figure 8-5 shows typical signatures (low, medium 1, medium 2, and high range) and waveforms, plus the circuit equivalent for a good silicon diode. The forward junction voltage drop of a diode can be determined (approximately) from the low range signature (each horizontal division is approx. 2.5 Volts).

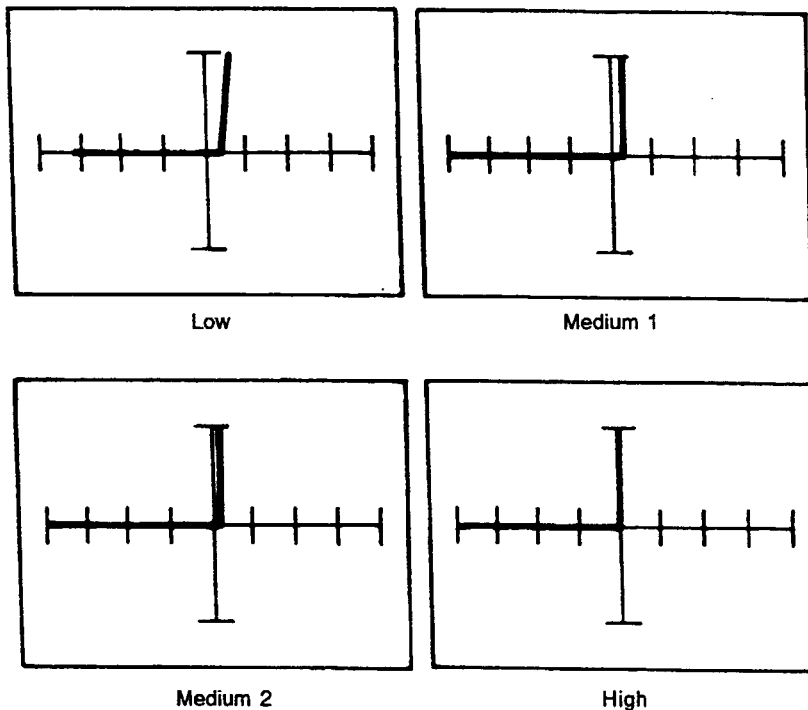
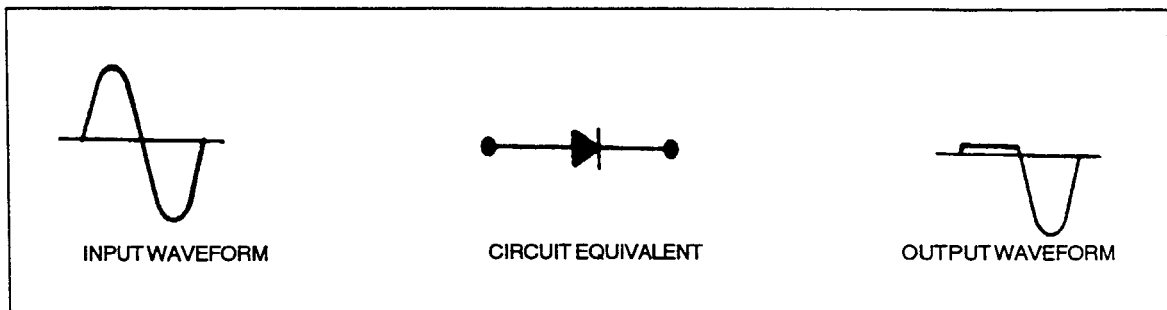

Figure 8-5. Signatures of a Silicon Diode at 60 Hz.

## 8-6. Signatures Of Defective Diodes

A diode is defective if it is open, is shorted (low impedance), exhibits high internal impedance, or exhibits leakage. Figure 8-6 shows the signatures of an "open" diode in all ranges.

The 2000 is capable, in the low range, of detecting resistance higher than  $1\Omega$ , and this resistance causes the vertical line to rotate in a clockwise direction. The angle of rotation is a function of the resistance. Figure 8-7 shows the effect of circuit resistance on the trace rotation while in the low range. This small short circuit resistance does not cause rotation in the medium 1, medium 2 and high ranges.

Figure 8-8 shows the waveforms, circuit equivalent and signatures of a diode that exhibits a nonlinear resistance in series with the diode junction. This resistance effects the ability of the diode to turn on at the proper voltage, and causes excessive heat dissipation.

In low range, the 2000 is capable of detecting series resistance as low as  $1\Omega$ . However, Medium 1 range is only capable of detecting such resistance higher than  $50\Omega$ .

TESTING DIODES

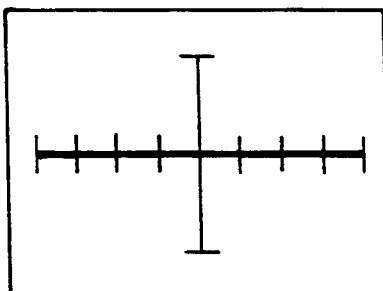

Figure 8-6. Signature of an Open Diode.

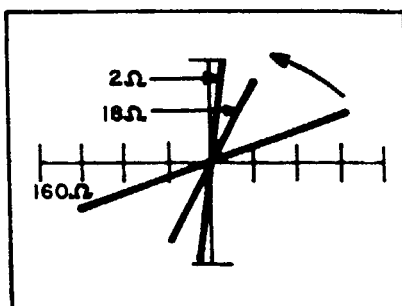

Figure 8-7. Effect of Resistance on the Signature in Low Range at 60 Hz.

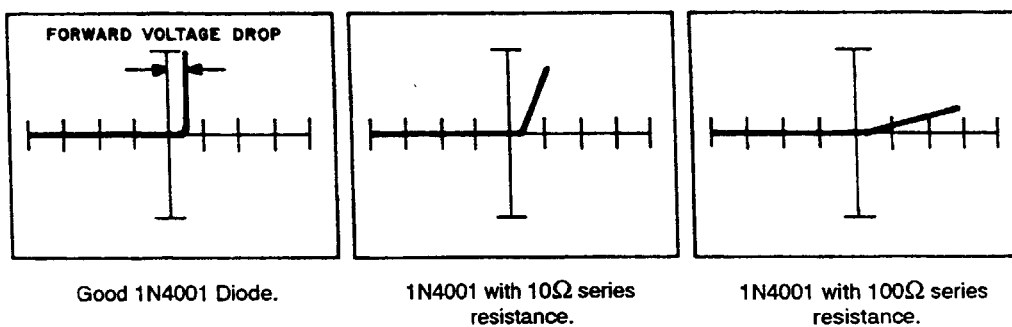
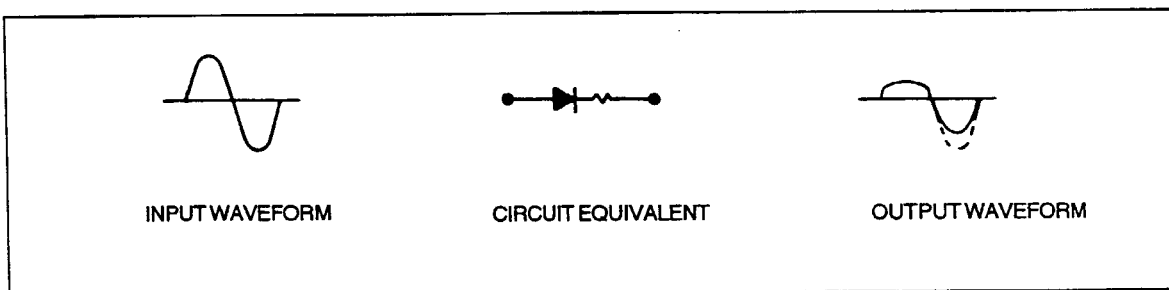

Figure 8-8a. Signature Deviation from a Good Diode in Low Range at 60Hz.

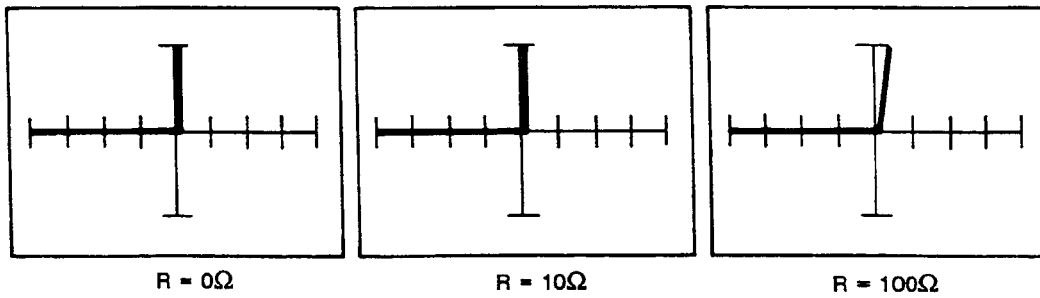

Figure 8-8b. Signature Deviation from a Good Diode at the Medium 1 Range at 60 Hz.

Another diode failure mode is leakage resistance which can be modeled as a resistance in parallel with a perfect diode shown in Figure 8-9a.

Figures 8-9a through 8-9e show the waveforms, circuit equivalent and signatures of a diode that exhibits a nonlinear resistance in parallel with the diode junction when reverse biased (leakage). This resistance effects the ability of the diode to provide maximum output for a given input. The 2000 is capable of detecting leakage resistance with values between 1Ω to 2 MΩ.

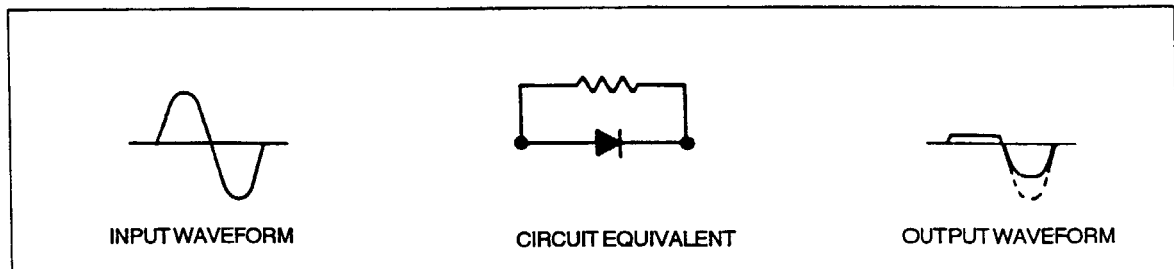

Figure 8-9a. Model of Diode with Leakage Resistance.

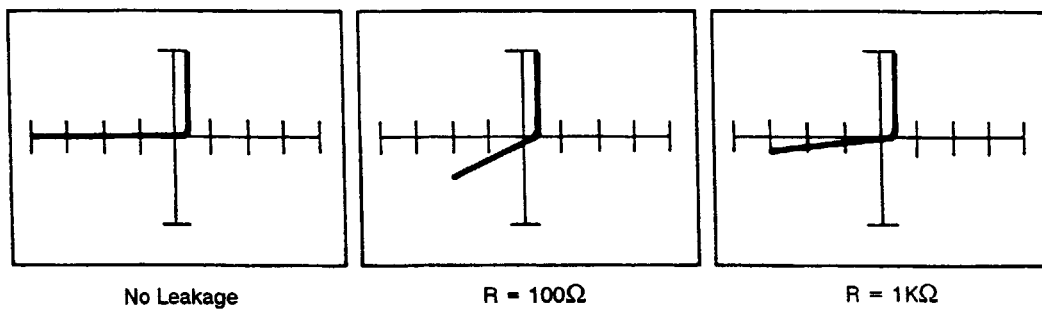

Figure 8-9b. Influence of Leakage Resistance in Low Range at 60 Hz.

TESTING DIODES

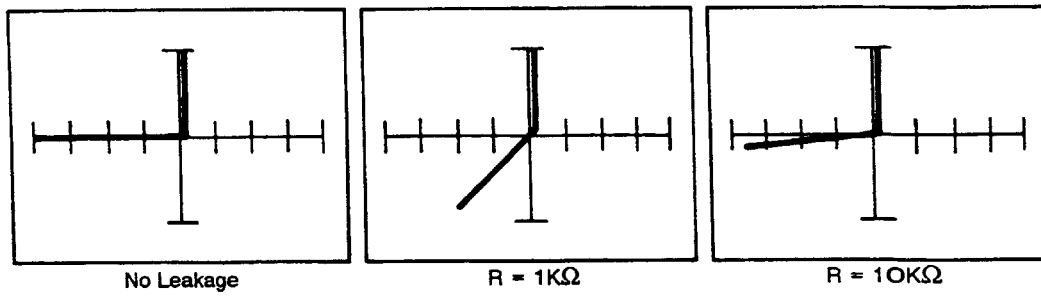

Figure 8-9c. Influence of Leakage Resistance in Medium 1 Range at 60 Hz.

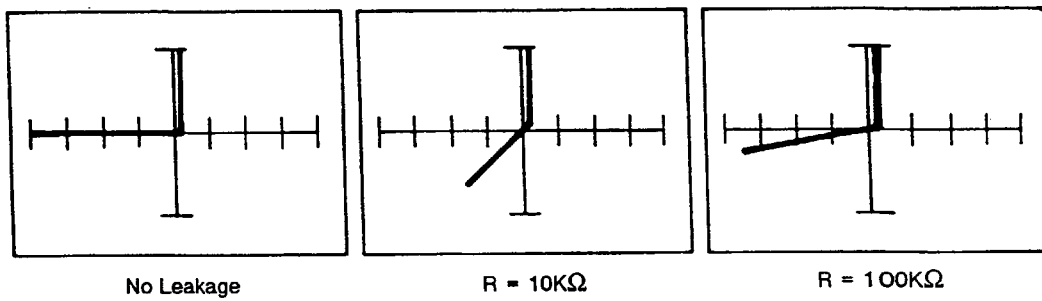

Figure 8-9d. Influence of Leakage Resistance in Medium 2 Range at 60 Hz.

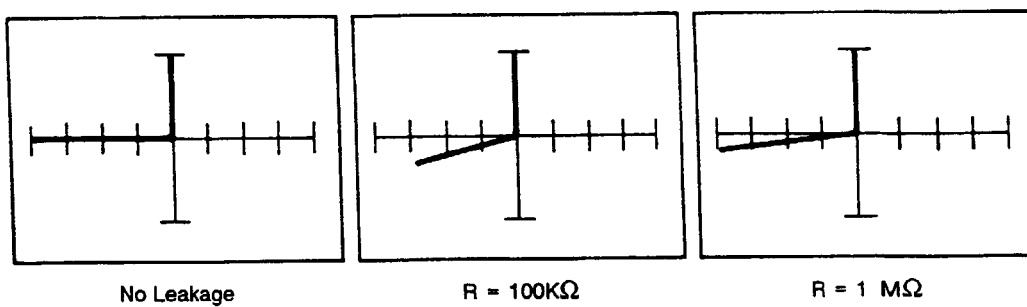

Figure 8-9e. Influence of Leakage Resistance in High Range at 60 Hz.



### 8-7. Signatures of a High Voltage Diode

High voltage diodes are tested in the same manner as that described for diodes in section 8-4. High voltage diodes, such as the HV30, display higher forward voltage drop ( $V_f$ ) than low voltage diodes because the doping is different and the diode junction must withstand the rated high voltage. High voltage diodes also exhibit higher junction capacitance. This capacitance is most easily viewed when using the 2000 Hz test frequency. Figures 8-10 a and b show the signatures of a 1N4001 and a HV30 (3KV breakdown) when they are tested at 60 Hz and 2000 Hz respectively.

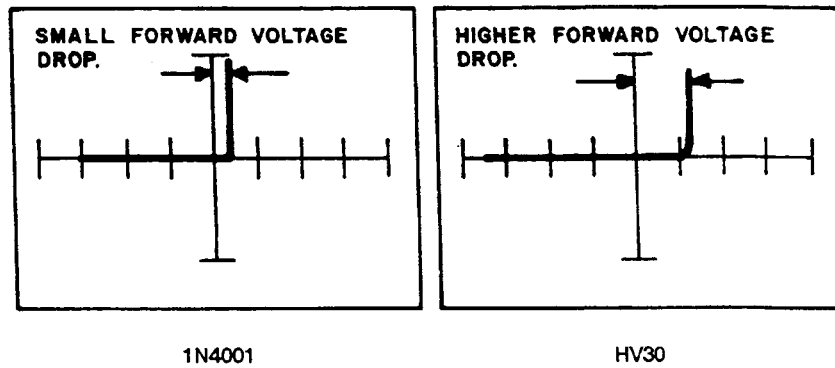

Figure 8-10a. Signatures of a 1N4001 and an HV30 in Low Range at 60 Hz.

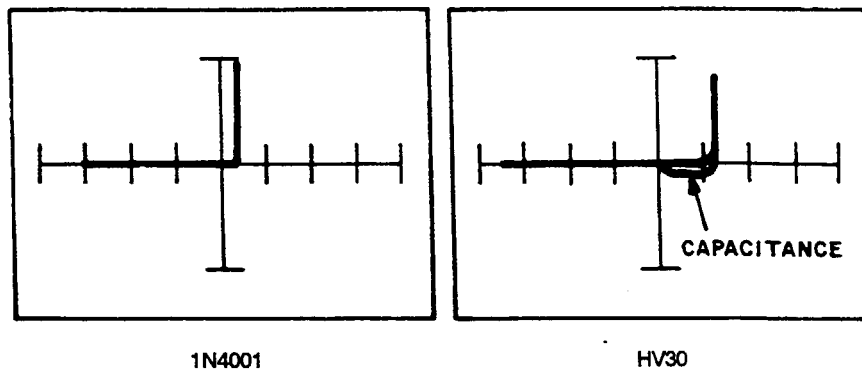

Figure 8-10b. Signatures of a 1N4001 and an HV30 in Low Range at 2000 Hz.

### 8-8. RECTIFIER BRIDGES

A rectifier bridge assembly is made up of four diodes configured as shown in Figure 8-11. Points A and B are the AC power input terminals, and points C and D are the positive and negative output terminals, respectively. To test the bridge, the 2000 is first connected to terminals A and B as shown in Figure 8-11.

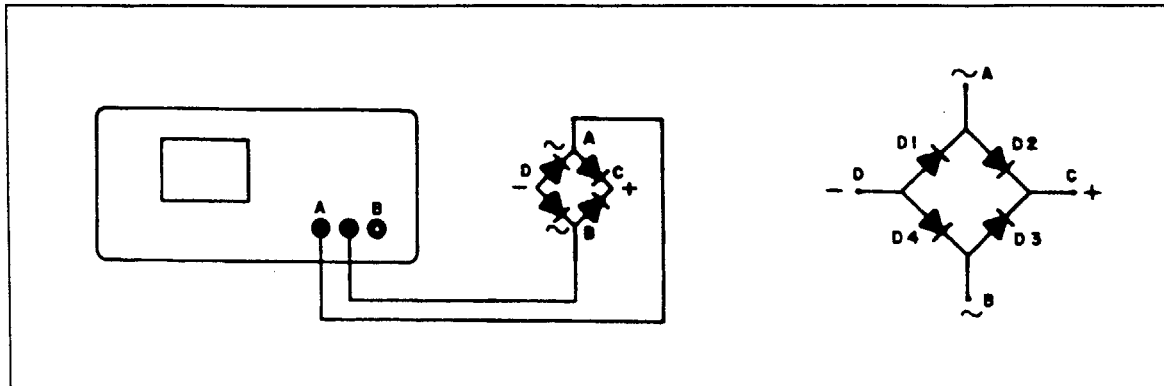

Figure 8-11. Rectifier Bridge Test Connections - AC Input.

A good bridge appears as an open circuit to the 2000 because the diodes are reverse biased. Figure 8-12 shows the signature produced by a good bridge with the 2000 connected across points A and B. Figure 8-13 shows the signatures produced by a bridge with either diode D2 or D4 shorted, while Figure 8-14 shows the signature produced with either diode D1 or D3 shorted.

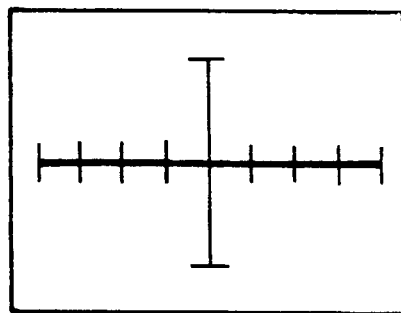

Figure 8-12. Signature of a Good Rectifier Bridge (All Ranges at 60 Hz).

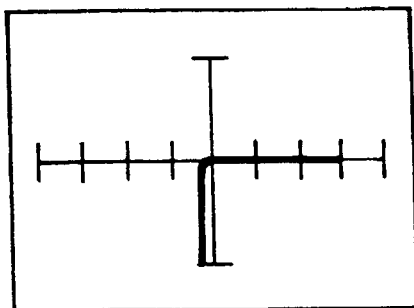

Figure 8-13.  
Signature with D2 or D4 Shorted in Low  
Range at 60 Hz.

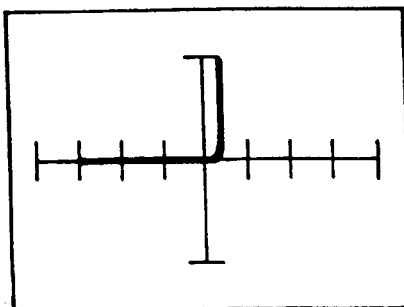

Figure 8-14.  
Signature with D1 or D3 Shorted in Low  
Range at 60 Hz.

Figure 8-15 shows the test connections of the 2000 to the positive and negative terminals of the rectifier bridge. Channel A is connected to the positive terminal, and common is connected to the negative terminal. Figure 8-16 shows signatures of a good bridge when connected as shown in Figure 8-15.

Figure 8-17 shows a reversal of the test connections shown in Figure 8-15. Figure 8-18 shows the signatures resulting from the reversal of the test connections to the bridge.

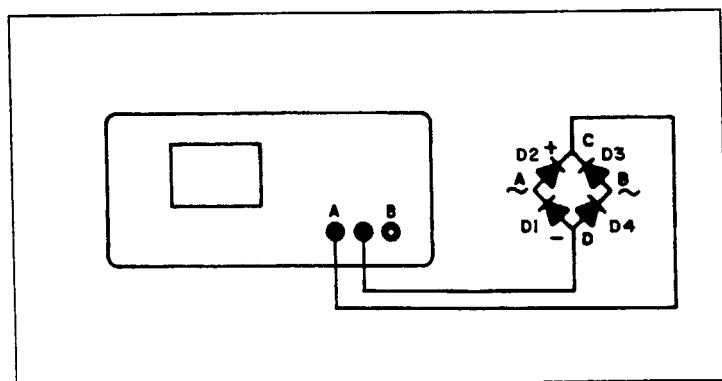

Figure 8-15. Rectifier Bridge Connections — DC Output.

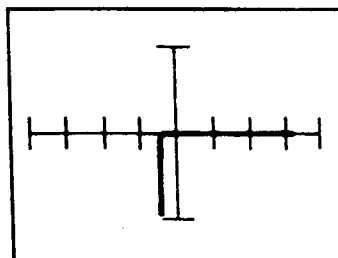

Figure 8-16. Signature of the DC  
Output in Low Range at 60 Hz.

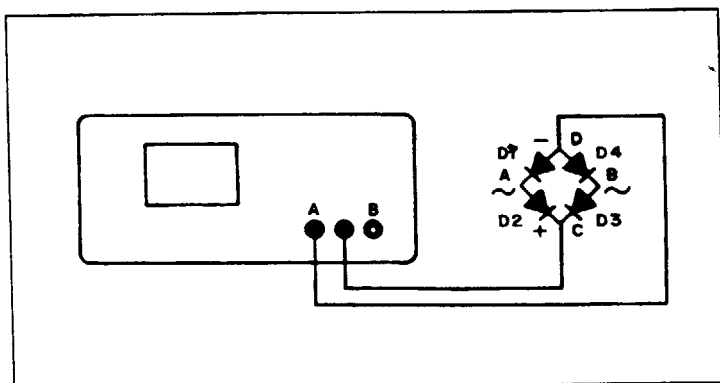

Figure 8-17. Rectifier Bridge - Reversed Test Connections.

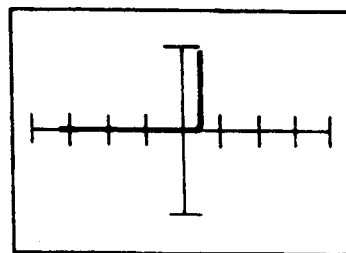

Figure 8-18. Signature with DC  
Output Reversed in Low Range  
at 60 Hz.

### 8-9. LIGHT EMITTING DIODES

Light emitting diodes (LEDs) may be tested with the 2000 by using the low range and connecting the probes across the LED. A good LED provides an adequate amount of light as a result of the 2000 connections. Figure 8-19 shows the signatures for different colored LEDs, each of which exhibit different forward voltages ( $V_f$ ).

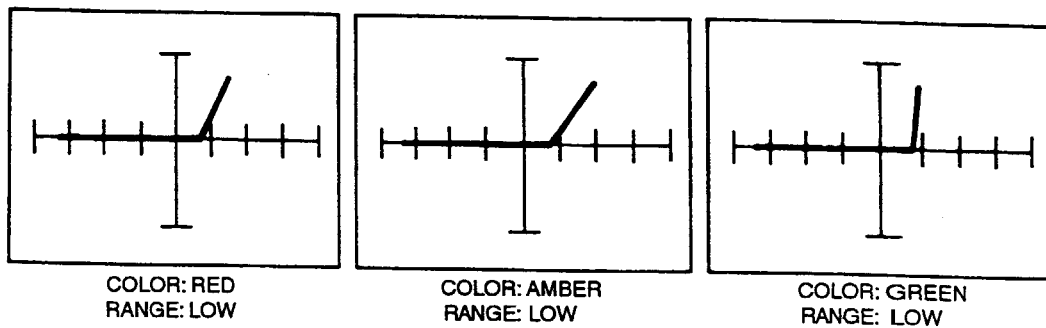

Figure 8-19. LED Signatures.

### 8-10. ZENER DIODES

The zener diode is unique among the semiconductor family of devices in that its electrical properties are derived from a rectifying junction which operates in the reverse bias region. Figure 8-20 shows the volt-ampere characteristics of a typical 30 Volt zener diode.

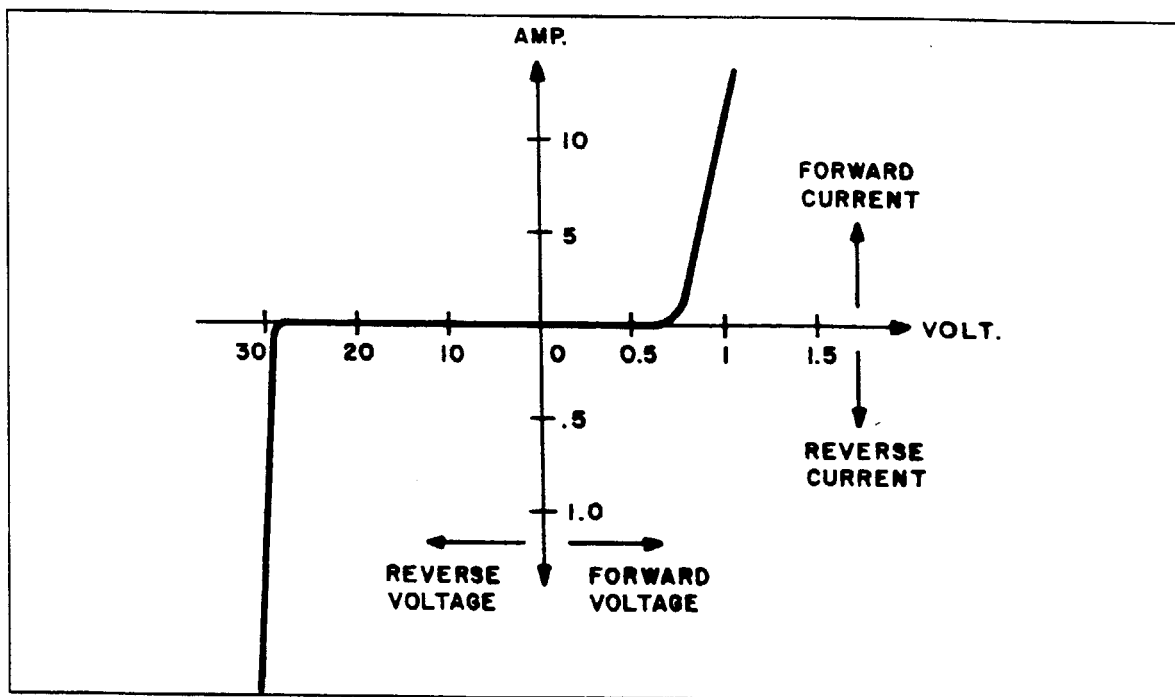

Figure 8-20. Characteristics of a Typical 30V Zener Diode.

Figure 8-20 shows that the zener diode conducts current in both directions, with the forward current being a function of the forward voltage. Note that the forward current is small until the forward voltage is approximately 0.65V, then the forward current increases rapidly. When the forward voltage is greater than 0.65V, the forward current is limited primarily by the circuit resistance external to the diode. This is essentially equivalent to a regular silicon diode for current flow in the forward direction.

The reverse current is a function of the reverse voltage and, for most practical purposes, is zero until such time as the reverse voltage equals the PN junction breakdown voltage. At this point the reverse current increases rapidly. The PN junction breakdown voltage ( $V_z$ ) is usually called the zener voltage. Commercial zener diodes are available with zener voltages from about 2.4 V to 200V. The 2000 displays the zener diode breakdown voltage ( $V_z$ ) on the display.

Figure 8-21 shows the signatures produced by the zener diode.

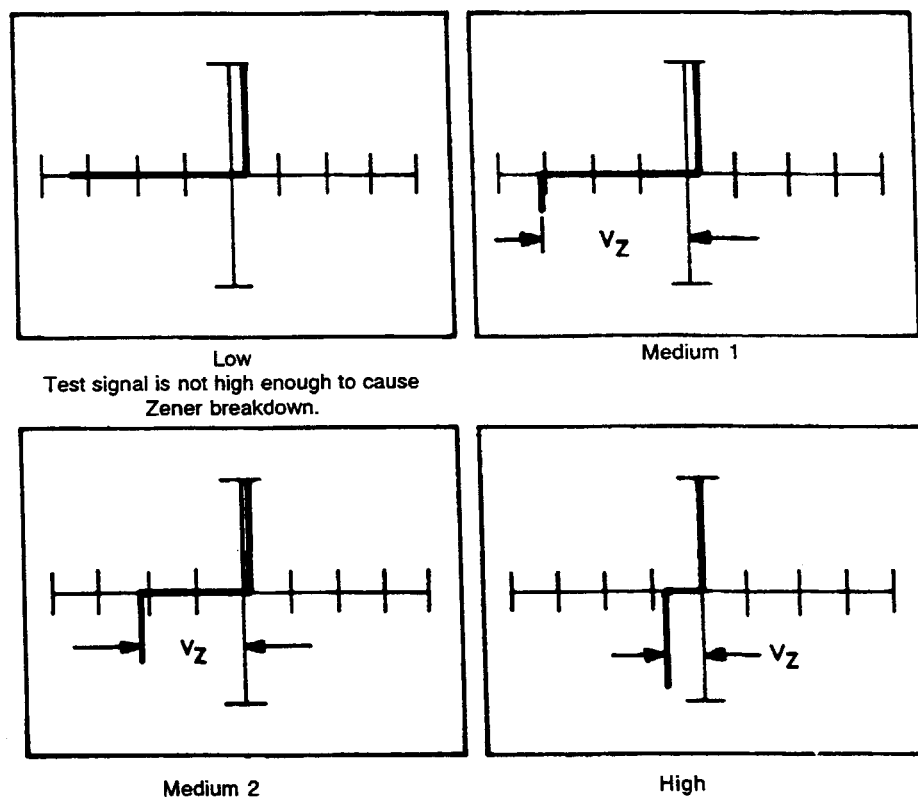
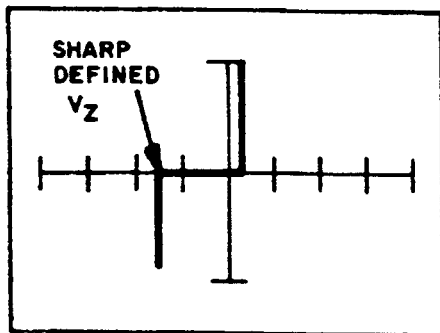

Figure 8-21. Signatures of a 1N5242 Zener Diode at 60 Hz.

In the low range, the 2000 test signal at the probes is 10 Volts peak which is insufficient to cause zener breakdown for the 1N5242. As a result, the signature looks identical to that of a general purpose diode such as a 1N4001. However, in the medium 1 range, the 2000 test signal is 15 Volts peak and the zener voltage ( $V_z$ ) can be seen.

## TESTING DIODES

A good zener diode gives a sharp, well-defined signature of zener breakdown voltage, while an inferior zener device gives a signature with a rounded corner (refer to Figures 8-22 and 8-23).



Figures 8-22. Signature of a good Zener Diode in Medium 1 Range at 60 Hz.

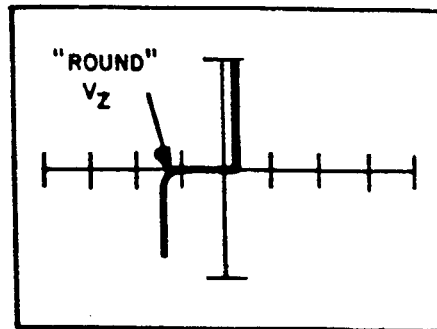

Figures 8-23. Signature of an inferior Zener Diode in Medium 1 Range at 60 Hz.

Figure 8-24 shows that the base-emitter junction of a silicon bipolar transistor (a PN2222) exhibits the property of a zener diode. The zener voltage ( $V_Z$ ) can be determined from the signature. In this example,  $V_Z$  is approximately 6.3 Volts.

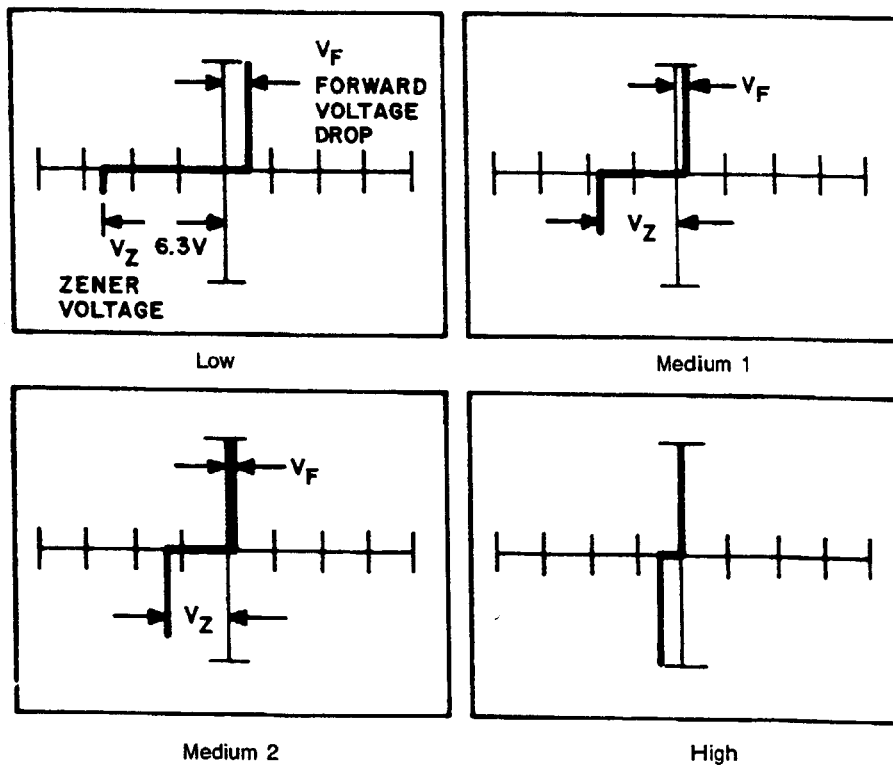

Figure 8-24. Signatures of a PN2222 B-E Junction at 60Hz.

Figure 8-25 shows the effect of testing the PN2222 B-E junction in the high range at 2000 Hz. The capacitance of the junction causes a loop to appear.

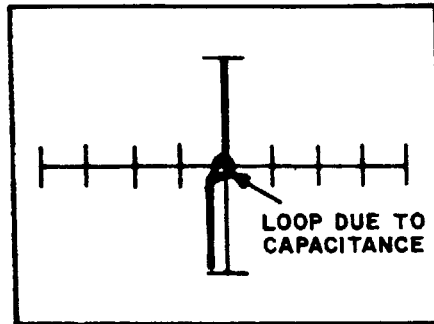

Figure 8-25. Signature of a PN2222 B-E Junction in High Range at 2000 Hz.

**TESTING DIODES**

**NOTES:**



# SECTION 9

## TESTING TRANSISTORS

### 9-1. BIPOLAR JUNCTION TRANSISTORS

A bipolar junction transistor consists of a silicon crystal in which a layer of N-type silicon is sandwiched between two layers of P-type silicon. This type of transistor is referred to as a PNP type. Figure 9-1 shows a PNP and its circuit symbol.

A transistor may also consist of a layer of P-type silicon sandwiched between two layers of N-type silicon. This is referred to as an NPN transistor. Figure 9-2 shows an NPN transistor and its circuit symbol.

The three layers of a transistor are known as the emitter, base, and collector. The arrow on the emitter lead specifies the direction of current flow when the base-emitter is biased in the forward direction.

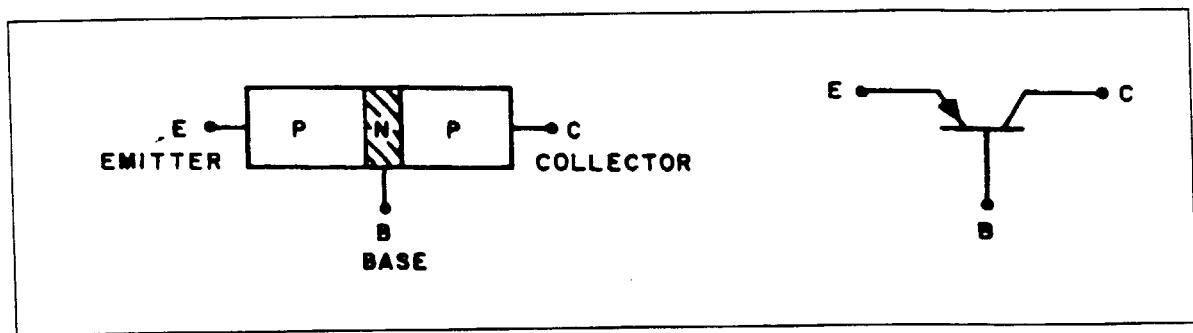

Figure 9-1. PNP Transistor and Circuit Symbol.

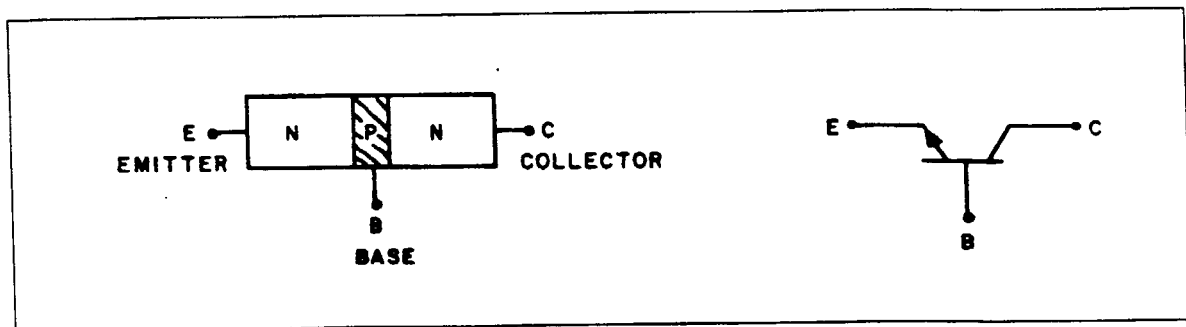

Figure 9-2. NPN Transistor and Circuit Symbol.

The test signals at the 2000 probes are sinusoidal and can be used to forward bias, as well as reverse bias, a semiconductor junction. To test a transistor, the base-emitter (B-E), collector-base (C-B), and a collector-emitter (C-E) connections all need to be examined.

## 9-2. An Important Note About Testing Transistors

Use of this instrument may alter the current gain ( $h_{FE}$  or  $\beta$ ) of a bipolar transistor whenever the emitter is tested. Either the base-emitter or collector-emitter test circuits satisfy this criterion. While heating of the device due to the current produced by the instrument may cause a temporary change in  $h_{FE}$  (most noticeable in the low range), a permanent shift in  $h_{FE}$  may occur whenever the base-emitter junction is forced into reverse breakdown ( $\approx 6-20$  Volts). The magnitude of the shift depends on the duration of the test and the range selected with the low current ranges, MED2 and HIGH, producing the smallest changes.

Most bipolar transistor circuit designers take into account a wide variation in  $h_{FE}$  as a normal occurrence and design the related circuitry to function properly over the expected range of  $h_{FE}$ . The effects mentioned above are for the most part much smaller than the normal device variation so that the use of this instrument will have no effect on the functionality of good devices and can fulfill its intended purpose of a means to locate faulty components. However, some circuits may depend on the  $h_{FE}$  of the particular part in use e.g. instrumentation that is calibrated to a certain  $h_{FE}$  value, or precision differential amplifiers with matched transistors. In such instances, this instrument should not be used as its use may cause the  $h_{FE}$  to shift outside the limited range where calibration can correct for any change.

Suggestions to minimize effects on bipolar transistors:

1. Keep the duration of the test as short as possible.
2. Use the medium 2 or high ranges as much as possible.
3. Identify the base, emitter, and collector pins of the device and then test the collector-base junction to determine whether it is an NPN or PNP. Since the emitter is not tested there will be no effect on  $h_{FE}$ . Then use the three terminal test method described in Section 10, "Using the Pulse Generator". This test method does not reverse bias the base-emitter junction and can determine complete device functionality.

## 9-3. NPN BIPOLAR TRANSISTORS

A bipolar transistor consists of two PN junctions which the 2000 can examine in a manner similar to that used for testing diodes. Figure 9-3 shows an equivalent circuit for a NPN Bipolar transistor.

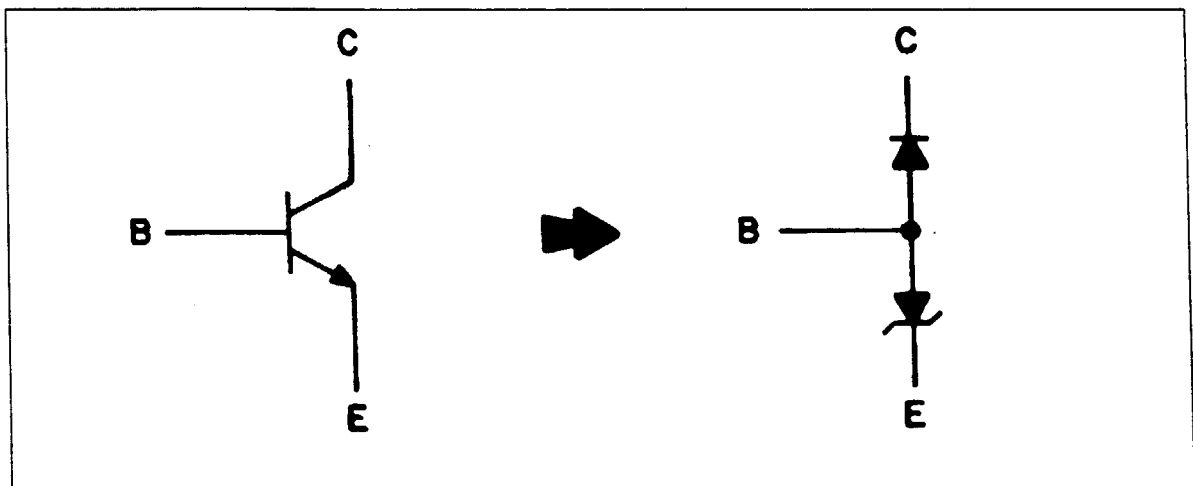

Figure 9-3. Equivalent Circuit of an NPN Transistor.

## 9-4. B-E Junction

The B-E junction exhibits a zener diode characteristic, i.e., normal diode voltage drop under forward bias, and zener breakdown under reverse bias with  $V_z$  usually in the range of 6 to 10 Volts. Figure 9-4 shows the signatures produced by the B-E junction of a 2N3904 NPN transistor in each range.

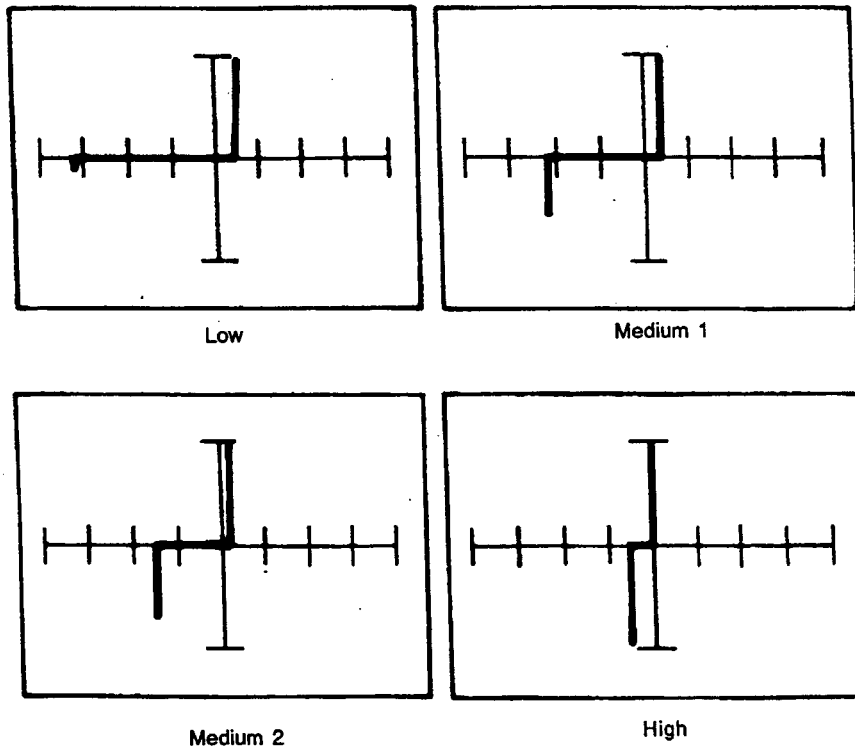

Figure 9-4. Signature of an NPN Transistor (2N3904) at 60 Hz Base with Emitter as Common.

## 9-5. C-B Junction

From Figure 9-3, it is seen that the C-B junction is a simple diode and it produces signatures like that of a diode in all ranges (refer to Figure 9-5).

## 9-6. C-E Connection

Referring to Figure 9-3, the C-E test examines a series connection of the two junctions, i.e., a simple diode in series with a zener diode. The resulting signatures are shown in Figure 9-6. When the collector is positive with respect to the emitter (right side of display) the C-B diode is reversed biased and the combination appears as an open circuit. This is expected because the normal operation of an NPN transistor uses positive C-E voltage and there is no base drive in the test circuit. When the collector is negative with respect to the emitter, the C-B diode is forward biased and the B-E junction goes into zener breakdown. The low impedance section of the signature is displaced to the left of the vertical axis by the sum of the voltage drops across the two junctions.

TESTING TRANSISTORS

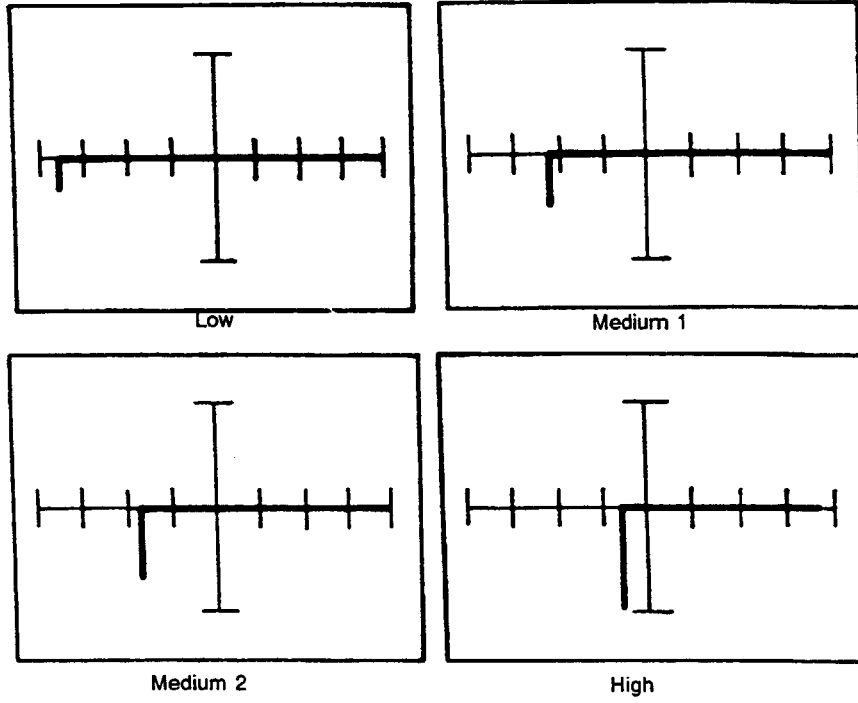

Figure 9-5. Signatures of an NPN Transistor (2N3904) at 60 Hz Collector with Base as Common.

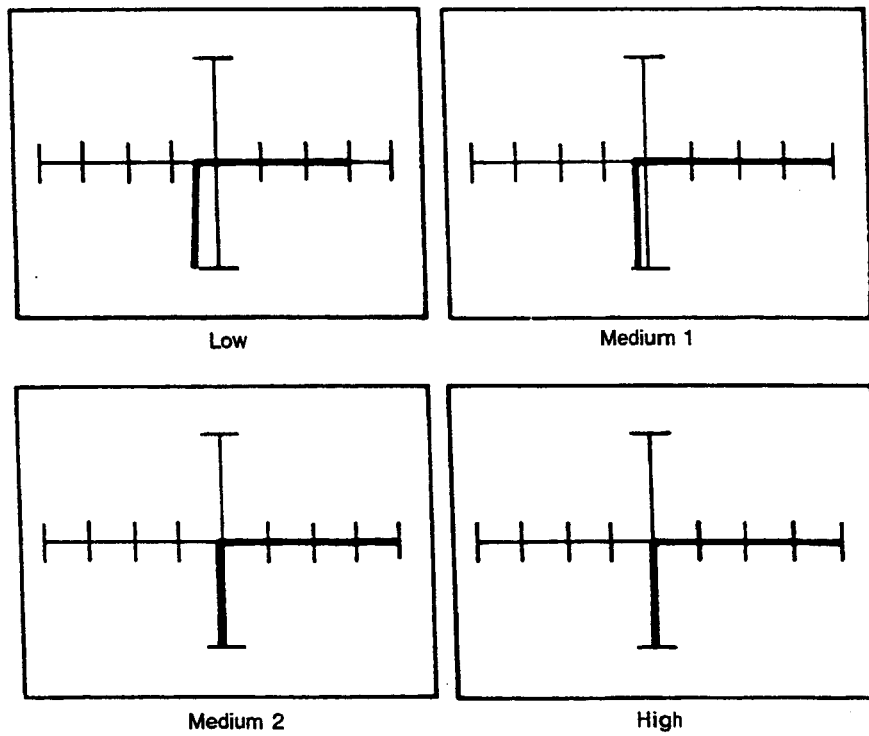

Figure 9-6. Signatures of an NPN Transistor (2N3904) at 60 Hz Collector with Emitter as Common.

### 9-7. PNP BIPOLAR TRANSISTORS

The testing of PNP transistors is the same as that described for NPN transistors, except that the signatures are reversed from those of an NPN device. This is because in the equivalent circuit of a PNP transistor the polarity of the two diodes is reversed (see Figure 9-7).

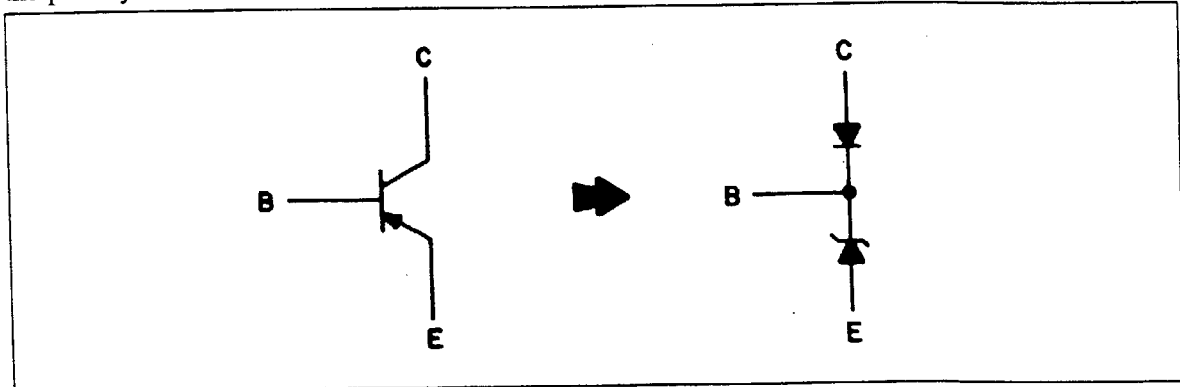

Figure 9-7. Equivalent Circuit of a PNP Transistor.

### 9-8. B-E Junction

The signatures produced by the Base-Emitter junction are shown in Figure 9-8.

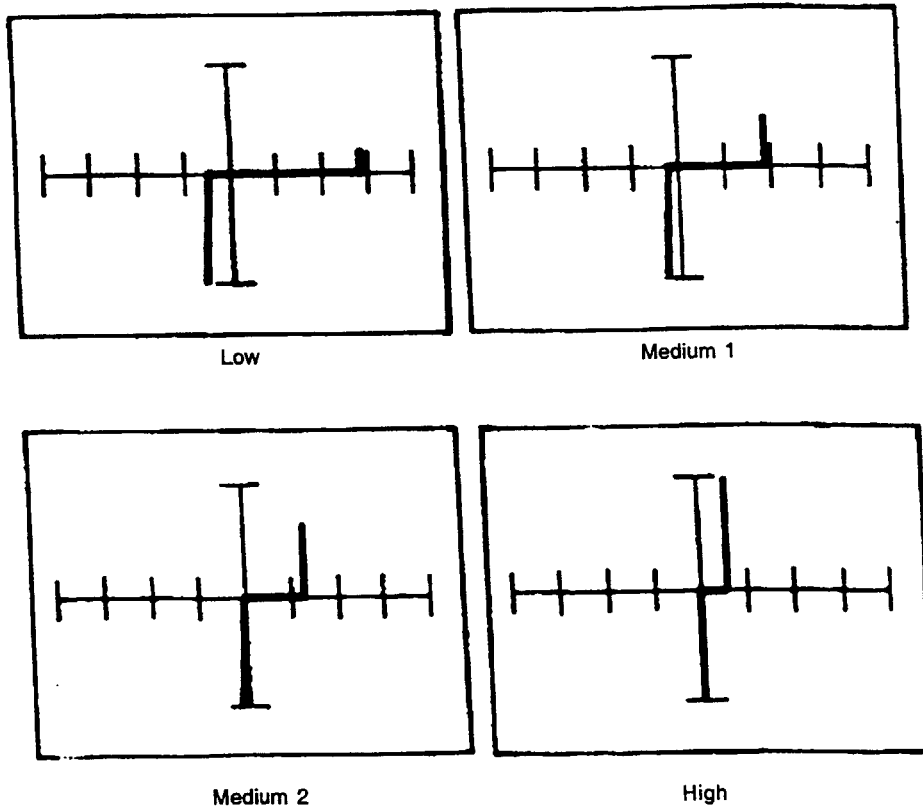

Figure 9-8. Signatures of a PNP Transistor (2N3906) at 60 Hz with Emitter as Common.

### 9-9. C-B Junction

The signatures of the Collector-Base junction are shown in Figure 9-9.

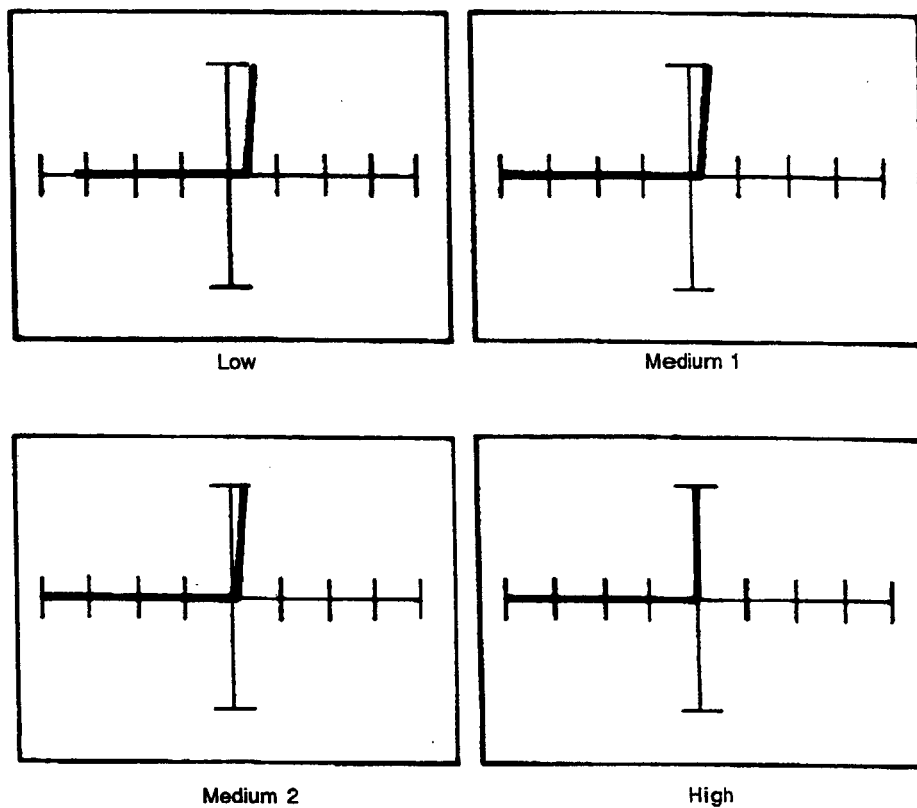

Figure 9-9. Signatures of a PNP Transistor (2N3906) at 60 Hz Collector with Base as Common.

9-10. C-E Connection

The signatures of the Collector-Emitter connection are shown in Figure 9-10.

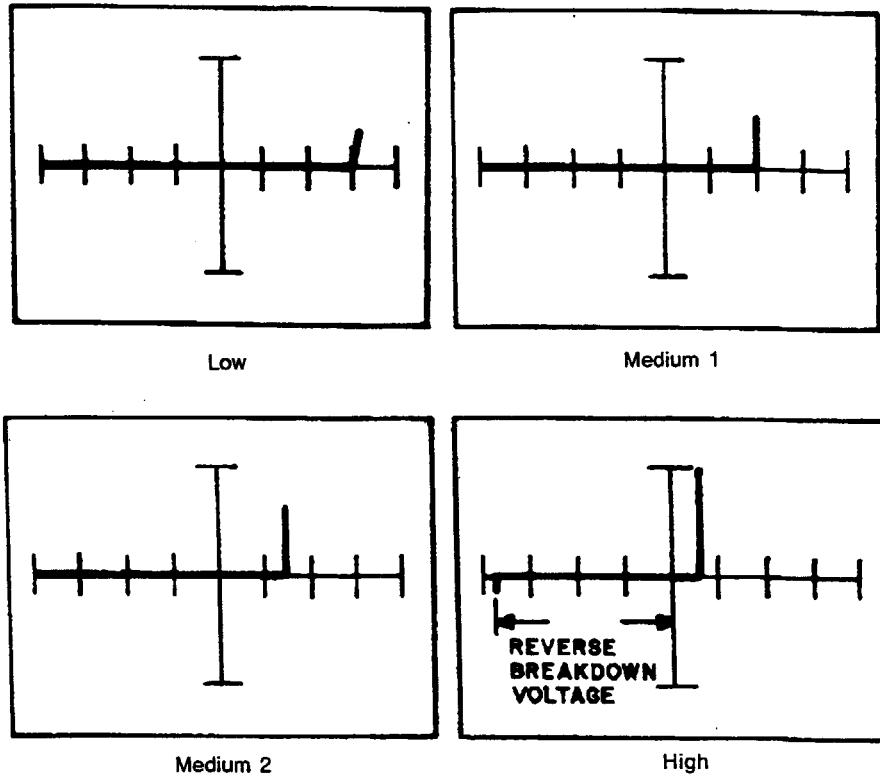

Figure 9-10. Signatures of a PNP Transistor (2N3906) at 60Hz Collector with Emitter as Common.

### 9-11. POWER TRANSISTORS - NPN AND PNP

Transistor testing procedures described in Sections 9-3 through 9-10 are applicable to power transistors. However, most power transistors show capacitance in the signature when the high range is used. Figure 9-11 shows the loop in the signature caused by capacitance.

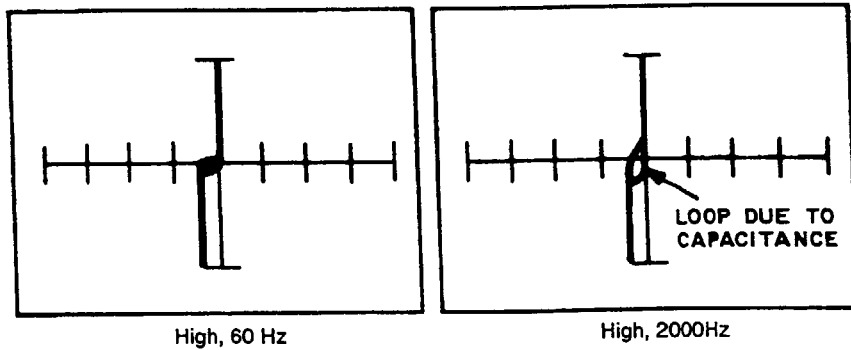
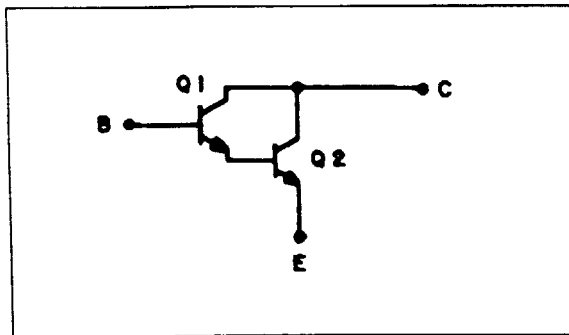

Figure 9-11. Signature of an NPN Power Transistor (TIP50) at 60 Hz and 2000 Hz. Base with Emitter as Common.

### 9-12. DARLINGTON TRANSISTORS



The Darlington transistor is basically two transistors connected to form a composite pair as shown in Figure 9-12. The input resistance of Q2 constitutes the emitter load for Q1.

Darlington transistors are tested in the same manner as NPN and PNP bipolar transistors, except their signatures differ. Figure 9-13 shows the equivalent circuit of a commonly used NPN Darlington transistor, the TIP112, and its pin assignments.

Figure 9-12. Darlington Transistor - Schematic Diagram.

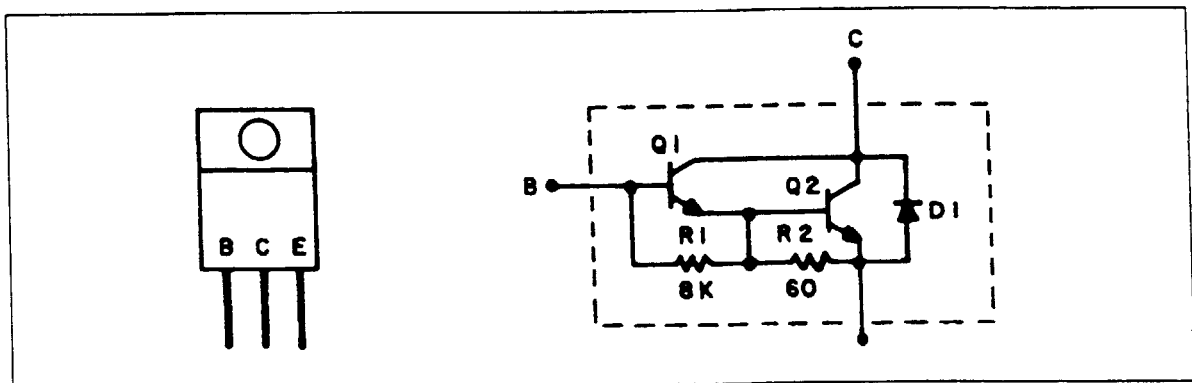

Figure 9-13. The TIP112 Darlington Transistor.



### 9-13. Comparing B-E Junctions

It is useful to compare the B-E junction of a Darlington transistor with that of a regular transistor. Figure 9-14 shows the test circuit and Figure 9-15 shows the signatures.

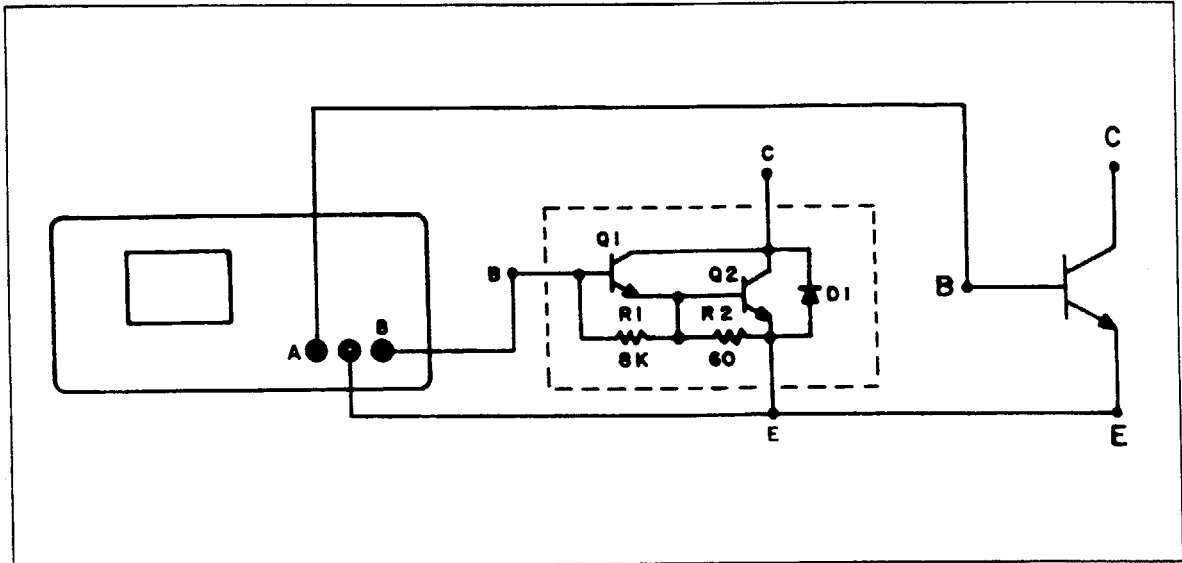
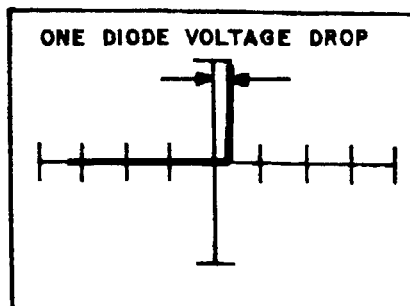
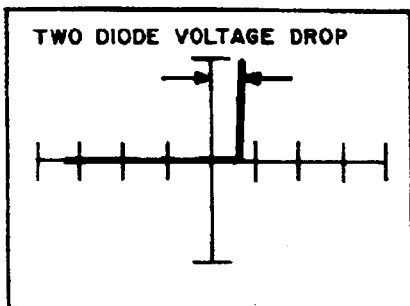

Figure 9-14. Base-Emitter Test Circuit.

TESTING TRANSISTORS

Darlington Transistor  
TIP112

Regular Transistor  
TIP29



Low

Low

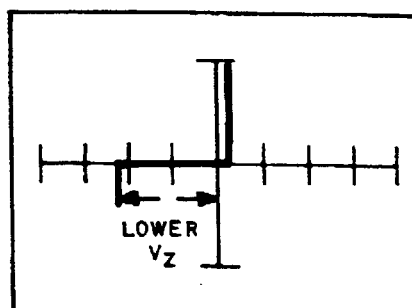
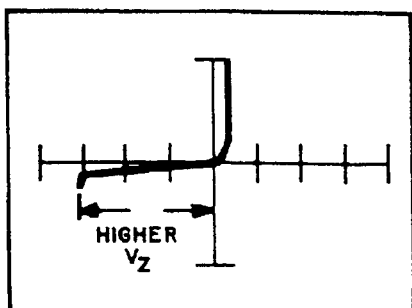

Medium 1

Medium 1

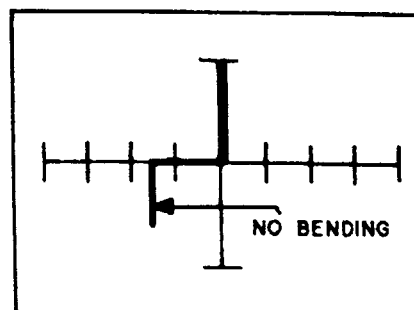
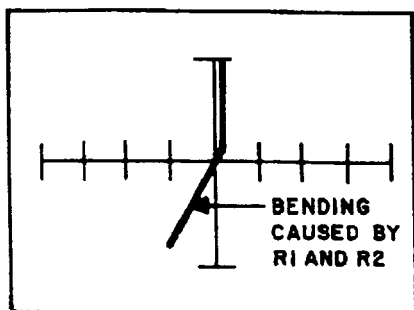

Medium 2

Medium 2

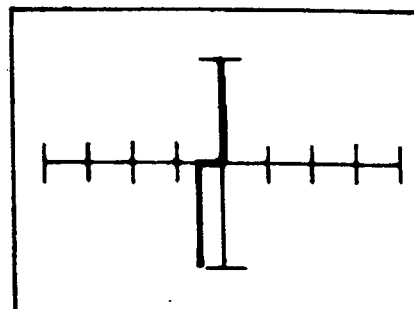
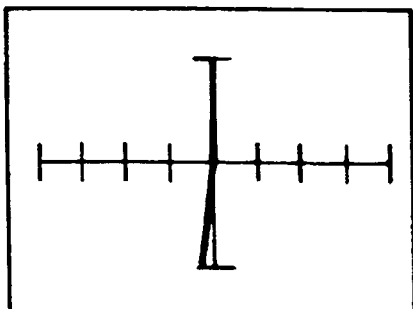

High

High

Figure 9-15. Signature Comparison of a Darlington Transistor (TIP112) and a Regular Transistor (TIP29) at 60 Hz. Base with Emitter as Common.

## 9-14. Comparing C-E Connections

This section compares the C-E connections of a Darlington transistor and a regular transistor. Figure 9-16 shows the test circuit and Figure 9-17 shows the signatures.

The left half of the Darlington signature is dominated by D1, while the left half of the regular transistor shows the C-B diode in series with the B-E zener. The right half of both signatures is an open circuit which is correct for any NPN device as that is the normal operating quadrant and there is zero base current.

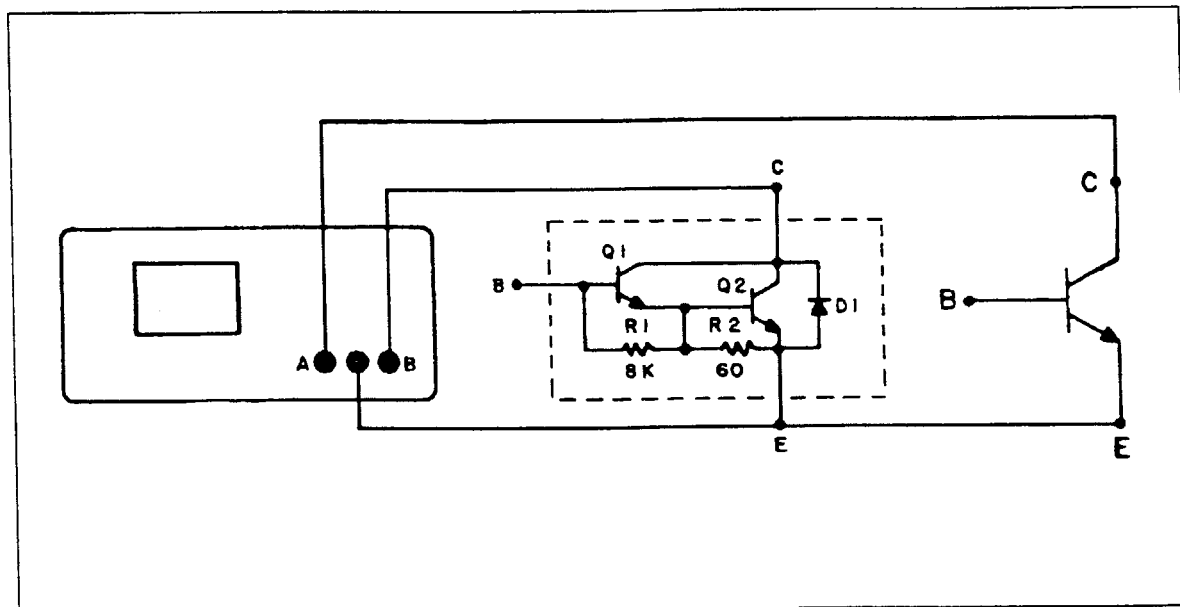

Figure 9-16. Collector-Emitter Test Circuit.

## 9-15. Comparing C-B Junctions

The C-B signatures of a Darlington transistor are the same as the C-E signatures. They are also the same as the C-B signatures of a regular transistor. The only difference is in what causes the signatures: in the Darlington, they are dominated by the C-B junction of Q1.

TESTING TRANSISTORS

Darlington Transistor  
TIP112

Regular Transistor  
TIP29

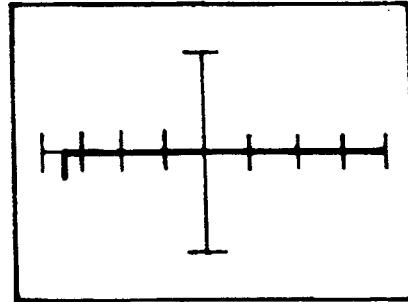
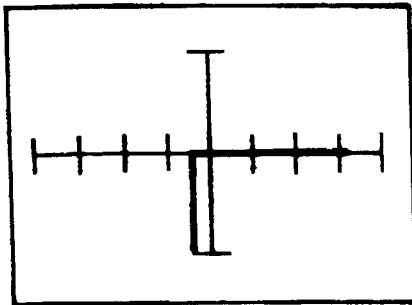

Low

Low

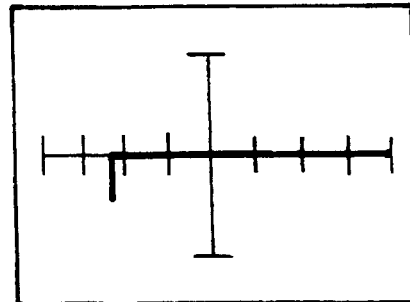
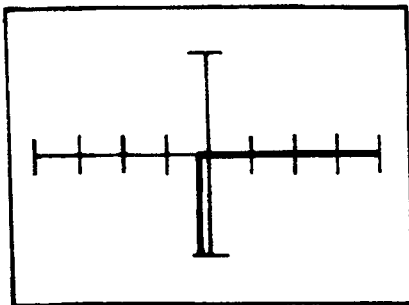

Medium 1

Medium 1

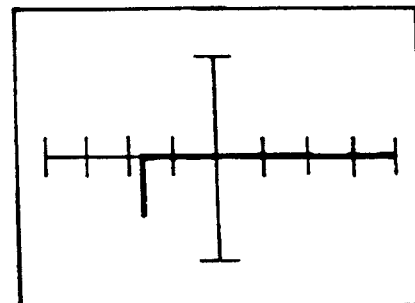
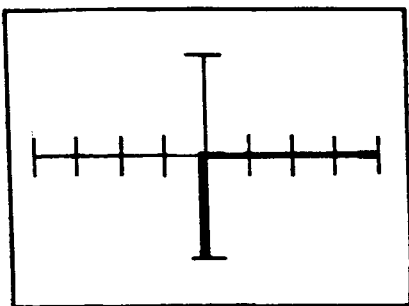

Medium 2

Medium 2

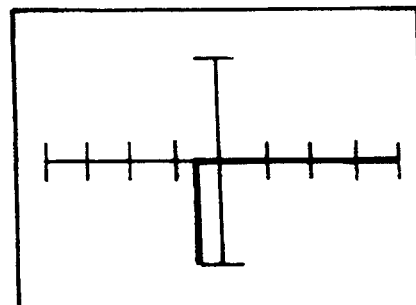
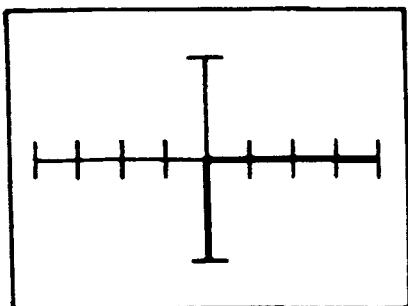

High

High

Figure 9-17. Signature Comparison of a Darlington Transistor (TIP112) and a Regular Transistor (TIP29) at 60 Hz. Collector with Emitter as Common.

## 9-16. JUNCTION FIELD EFFECT TRANSISTORS

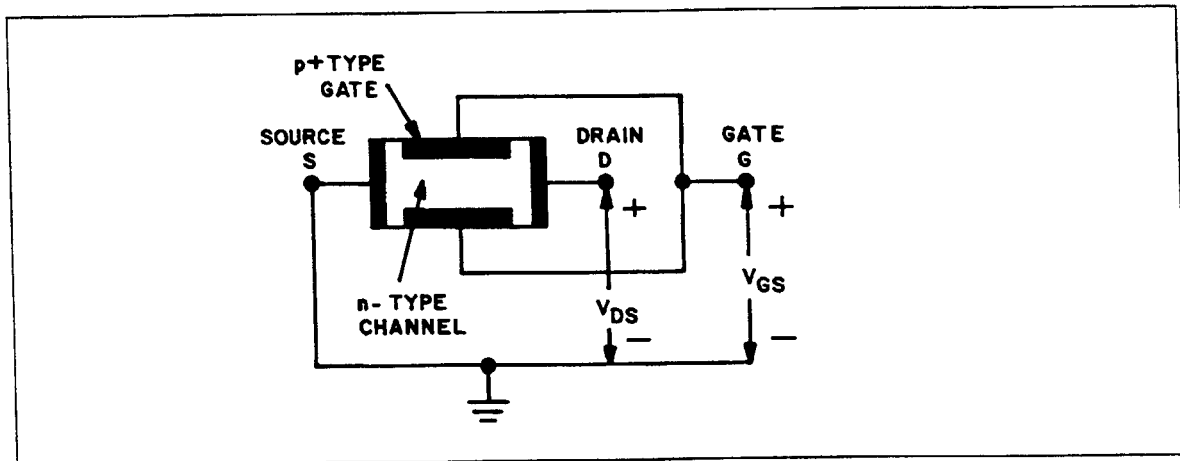

Figure 9-18. Basic Structure of an N-Channel JFET.  
(Note: In a P-channel JFET the voltages would be reversed.)

The structure of an N-channel Junction Field Effect Transistor (JFET) is shown in Figure 9-18. Resistive contacts are made to the ends of a semiconductor bar of N-type material (if P-type material is used, the device is referred to as a P-channel JFET). The voltage supply connected to the ends causes current to flow along the length of the bar. This current is made up of majority carriers, which in this case are electrons. The circuit symbol is shown in Figure 9-19.

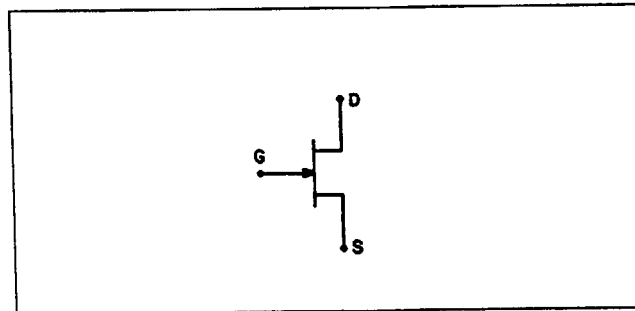

Figure 9-19. Circuit Symbol for an N-Channel JFET.

## TESTING TRANSISTORS

The following FET notation is standard:

**SOURCE:** The source (S) is the terminal at which the majority carriers enter the bar. The current entering the bar at S is designated by  $I_s$ .

**DRAIN:** The drain (D) is the terminal at which the majority carriers leave the bar. The current entering the bar at D is designated by  $I_d$ . If D is more positive than S, then the drain to source voltage is ( $V_{ds}$ ) positive.

**GATE:** On both sides of the N-type bar shown in Figure 9-18, heavily doped (P+ ) sections of acceptor impurities have been created by alloying, by diffusion, or by some other means of creating P-N junctions. These sections of impurities are called the gate (G). The gate to source voltage ( $V_{gs}$ ) is applied to reverse bias the P-N Junction. The current entering the bar is designated  $I_g$ .

**CHANNEL:** The section of N-type material between the two gate sections is the channel through which the majority carriers travel from source to drain.

### 9-17. Gate-Source Connection

The signatures of the Gate-Source connection are shown in Figure 9-20.

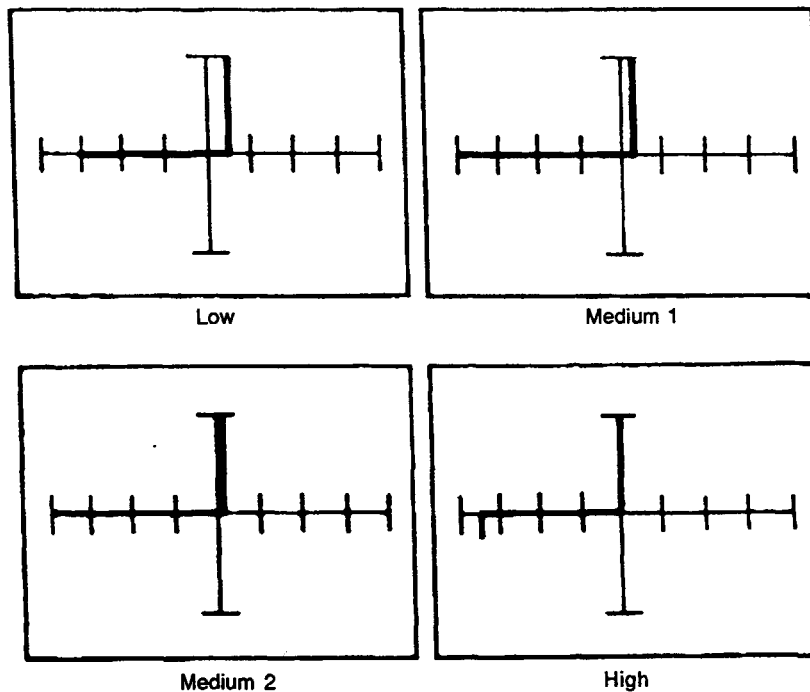

Figure 9-20. Signatures of an N-Channel JFET (2N5638) at 60 Hz. Gate with Source as Common.

### 9-18. Drain-Gate Connection

The signatures of the Drain-Gate connection are shown in Figure 9-21.

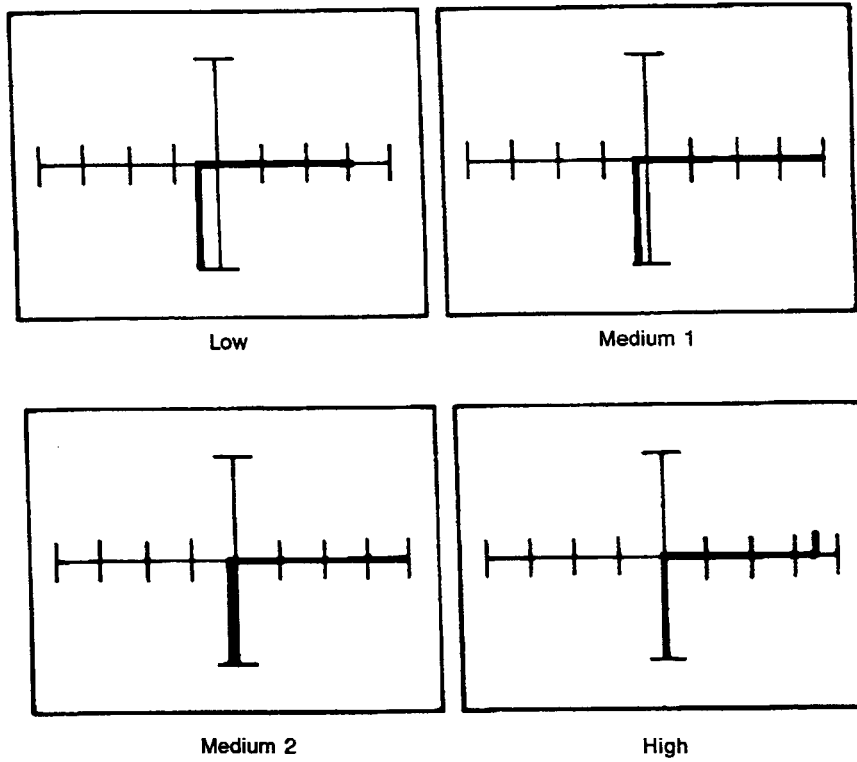

Figure 9-21. Signatures of an N-Channel JFET (2N5638) at 60 Hz. Drain with Gate as Common.

### 9-19. Drain-Source Connection

The signatures of the Drain-Source connection are shown in Figure 9-22.

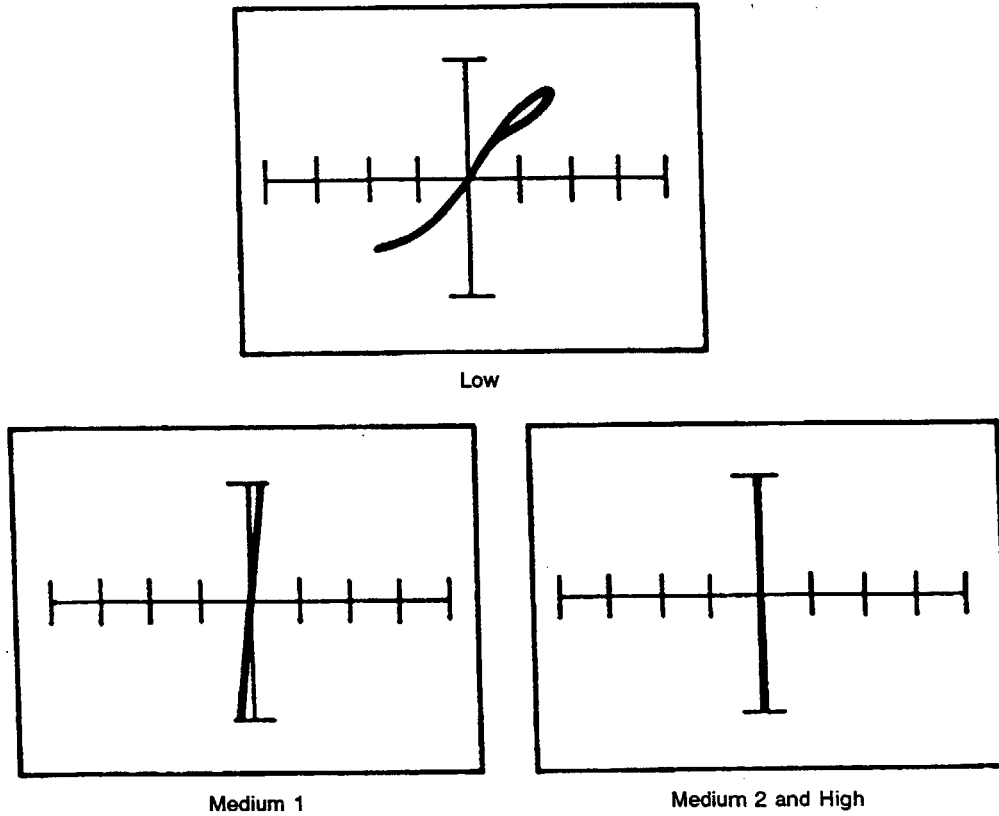

Figure 9-22. Signatures of an N-Channel JFET (2N5638) at 60 Hz. Drain with Source as Common.

### 9-20. MOS FIELD EFFECT TRANSISTORS

MOS field effect transistors (MOSFETs) are constructed as either “depletion” or “enhancement” mode devices. Each type requires a distinct test procedure with the 2000. Figure 9-23 shows the construction and circuit symbol of N-channel and P-channel MOSFETs. The depletion mode MOSFET is a “normally on” device. When  $V_{gs} = 0$ , a conducting path exists between source and drain. An enhancement mode MOSFET is a “normally off” device, and increasing the voltage applied to the gate will enhance channel conduction, and depletion will never occur.

Because MOS devices require higher voltage levels for testing than JFETs, the medium 2 range should be used. The amount of “in circuit” loading that can be tolerated is limited by the impedance of the signal generator inside the 2000.



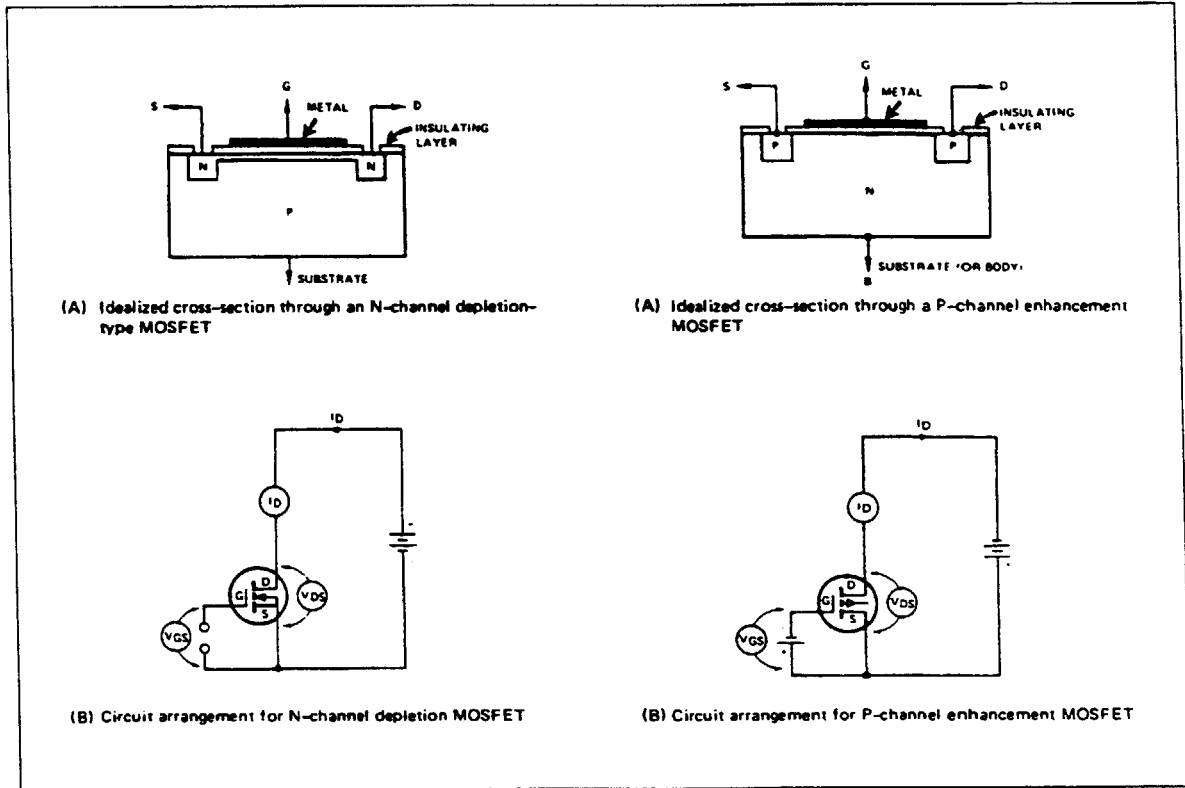

Figure 9-23. N-Channel and P-Channel MOSFET Devices.

### 9-21. MOSFET WITH PROTECTION DIODE

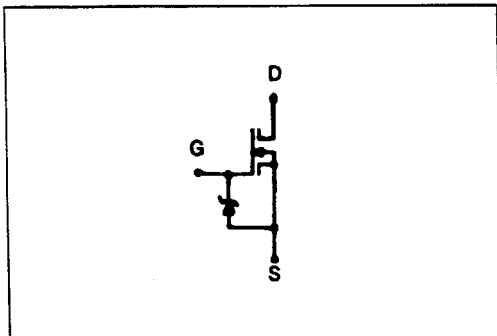

Figure 9-24. VN10KM MOSFET with a Gate-Source Protection Diode.

Some MOSFET devices have an input protection diode, and the 2000 displays the effect of this diode. Figure 9-24 shows a Siliconix N-channel enhancement mode MOSFET (VN10KM). This device has a protection diode between the gate and source.

### 9-22. Gate-Source Connection

Figure 9-25 shows the signatures of the protection zener diode in the low, medium 1, medium 2 and high ranges. The test signal in the low range is 10 Volts peak and is not high enough to cause zener breakdown. The test signal in the medium 2 range is 20 Volts peak and is just high enough to cause zener breakdown. However, in the high range, the test signal is sufficient to cause zener breakdown.

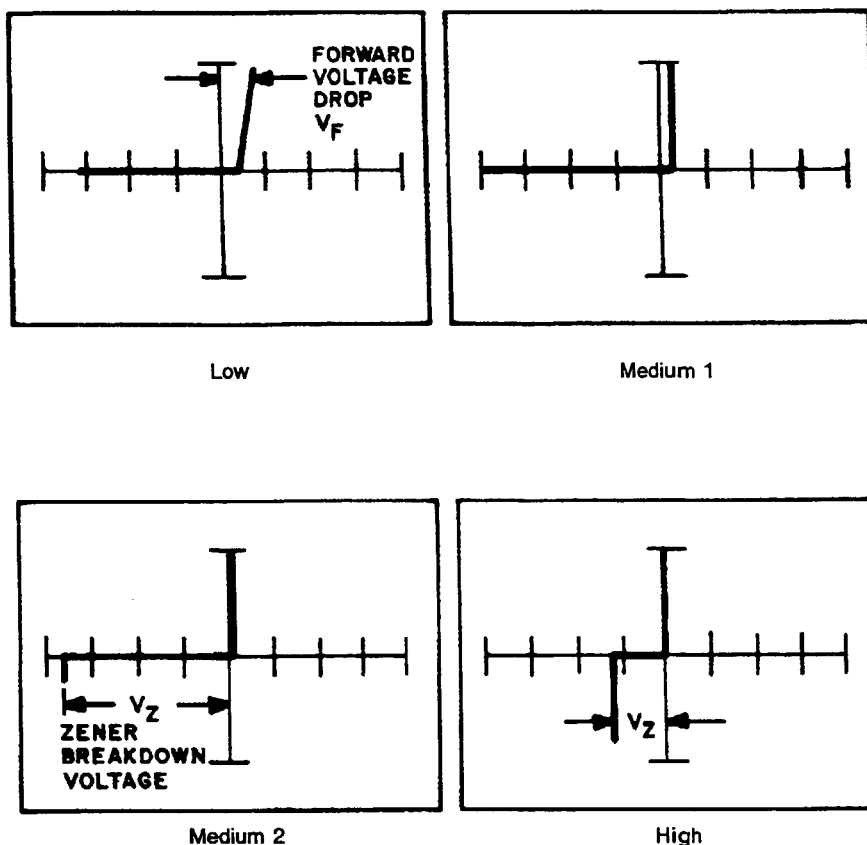

Figure 9-25. Signatures of an N-Channel Enhancement Mode MOSFET (VN10KM) at 60 Hz. Gate with Source as Common.

### 9-23. Drain-Gate Connection

The signatures of the Drain-Gate connection are shown in Figure 9-26.

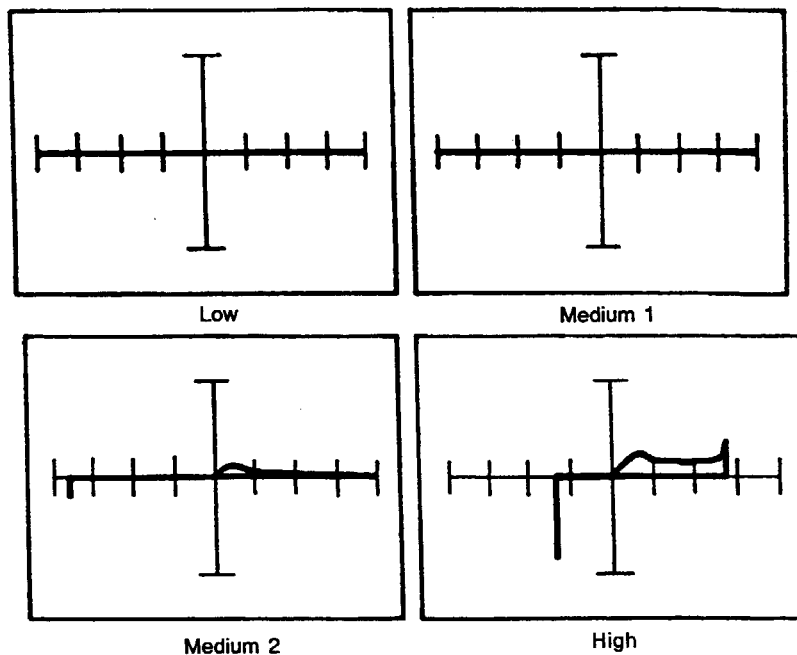

Figure 9-26. Signatures of an N-Channel Enhancement Mode MOSFET (VN10KM) at 60 Hz. Drain with Gate as Common.

### 9-24. Drain-Source Connection

The signatures of the Drain-Source connection are shown in Figure 9-27.

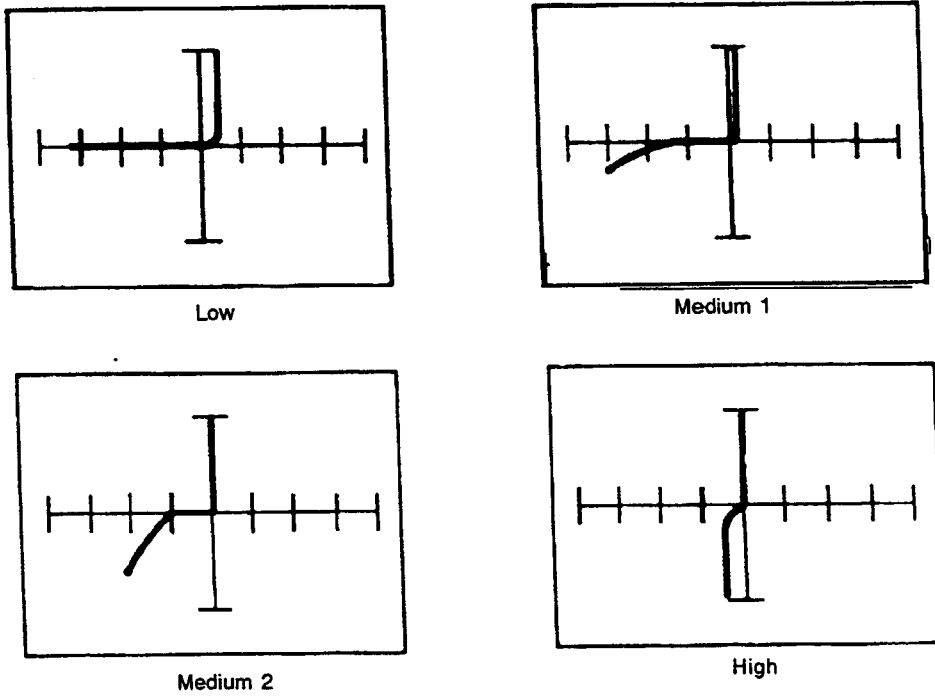

Figure 9-27. Signatures of an Enhancement Mode MOSFET (VN10KM) at 60 Hz.  
Drain with Source as Common. Gate Open Circuit.

## 9-25. MOSFET WITHOUT A PROTECTION DIODE

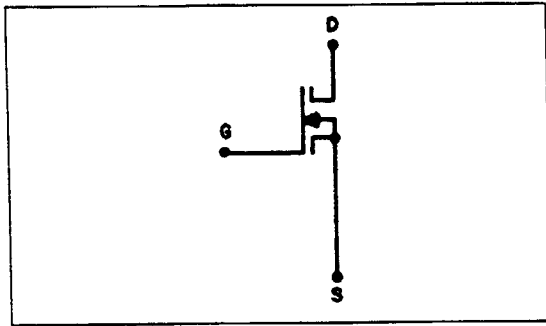

Figure 9-28. VN10LM MOSFET without a Gate-Source Protection Diode.

Figure 9-28 shows a Siliconix N-channel enhancement mode MOSFET (VN10LM). This device does not have a protection diode between the gate and source, and the substrate is internally connected to the source.

The signatures of Gate-Source Connection and the signatures of the Drain-Gate Connection are open circuit signatures. The signatures of the Drain-Source Connection are the same as the signatures of the Drain-Source Connection of the VN10KM (See Figure 9-27).

**TESTING TRANSISTORS**

**Notes:**

# SECTION 10

## USING THE PULSE GENERATOR

### 10-1. INTRODUCTION

The previous sections have dealt with using the 2000 with two test leads to check components. This method is all that is necessary to test two terminal components, and yields useful information for many three terminal components as well. However, the 2000 has additional capability to test three terminal devices using the built-in pulse generator. The pulse generator provides a signal to the control input of a device while the normal test terminals of the 2000 are used to examine the outputs of the device. This method puts the device under test in its active region and a signature is produced that is the result of the device turning on and off. Each test circuit in this section that uses the pulse generator shows the specific setup of the pulse generator selector buttons for the particular application. See Section 2-14 for pulse generator operation instructions.

### 10-2. SILICON CONTROLLED RECTIFIERS (SCRs)

The symbol and equivalent circuit of a silicon controlled rectifier is shown in Figure 10-1. An SCR looks like a diode across its gate-cathode junction. Note that the gate-cathode breakdown voltage can be observed in the High range.

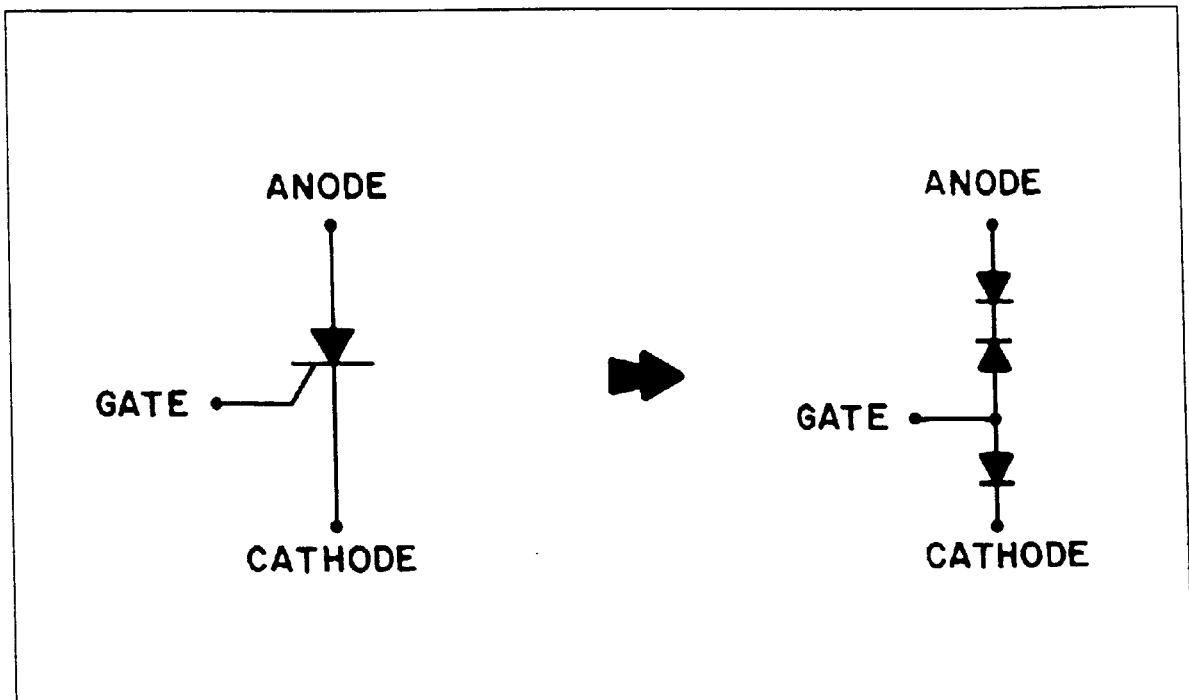

Figure 10-1. Silicon Controlled Rectifier.

USING THE PULSE GENERATOR

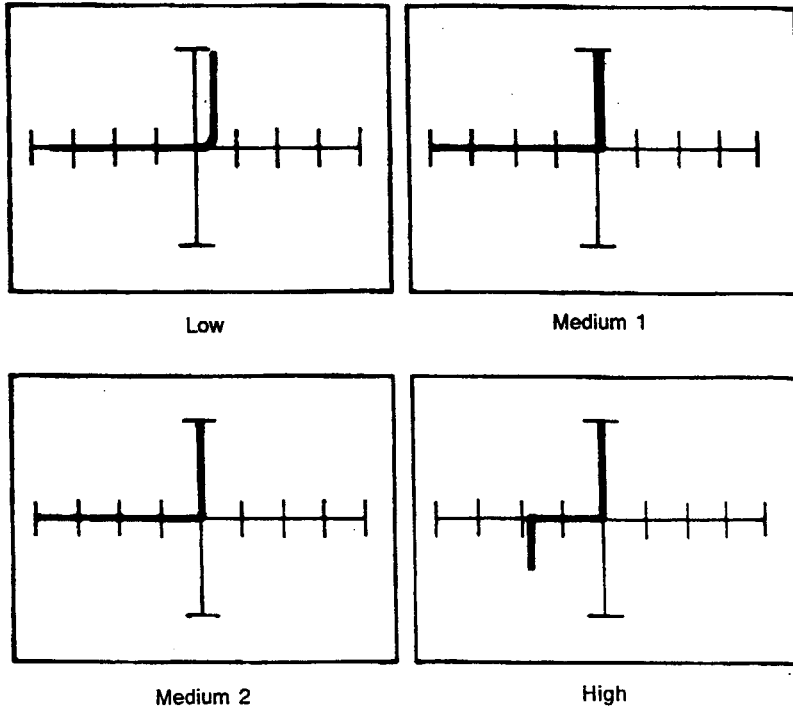

Figure 10-2. Signatures of a SCR (C103) at 60 Hz. Gate with Cathode as Common.

An SCR is equivalent to two diodes back to back between the gate and anode junction (see Figure 10-1). The 2000 displays these back to back diodes as an open circuit. The signatures for the anode-gate and anode-cathode connections are open circuit horizontal signatures in all ranges.

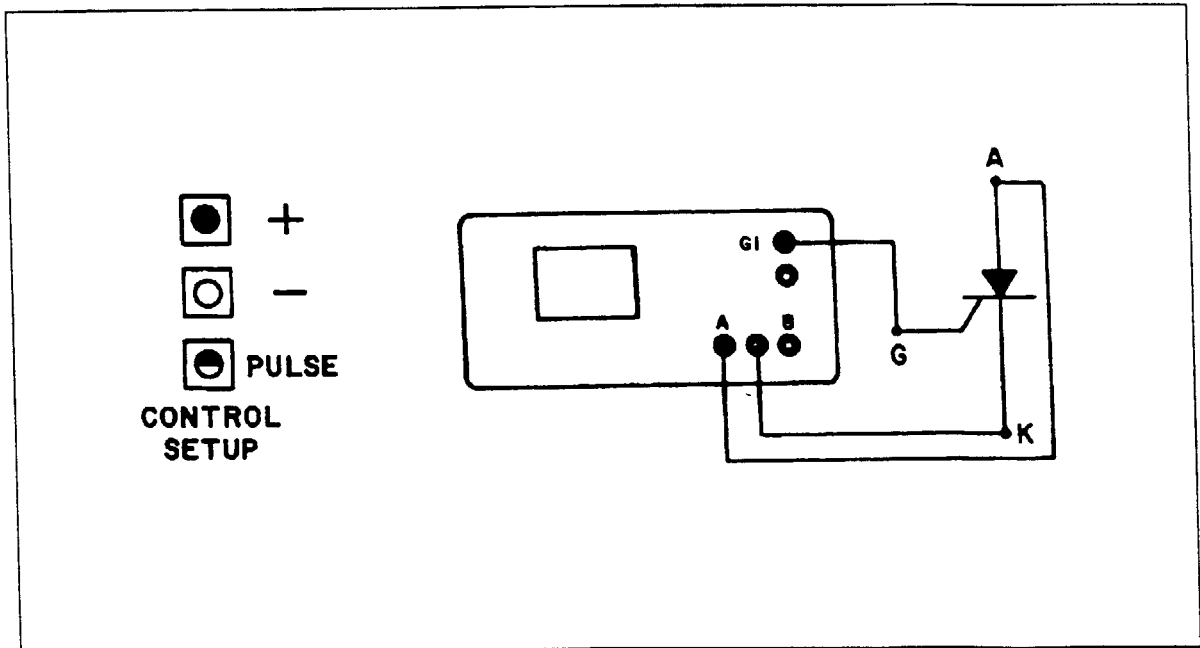

Figure 10-3. SCR Test Circuit Using the Pulse Generator.



The pulse generator can drive the gate of an SCR as shown in the test circuit of Figure 10-3. With the Level control at zero, a horizontal trace is displayed (see Figure 10-4). This is expected since SCRs normally show an open circuit between anode and cathode or between anode and gate. Using maximum pulse stimulus (width = max), a point is reached as the level is increased where the SCR turns on, and the signature becomes like that of a diode. This is shown in Figure 10-5 for an SCR in all ranges.

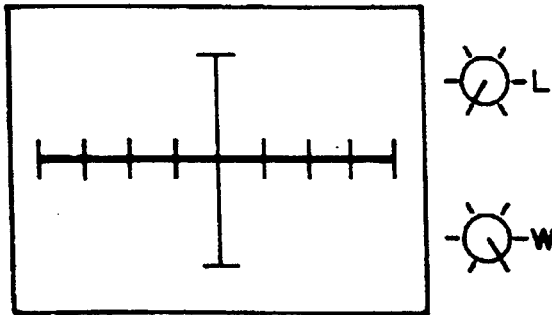

Figure 10-4. Zero Level All Ranges at 60 Hz.

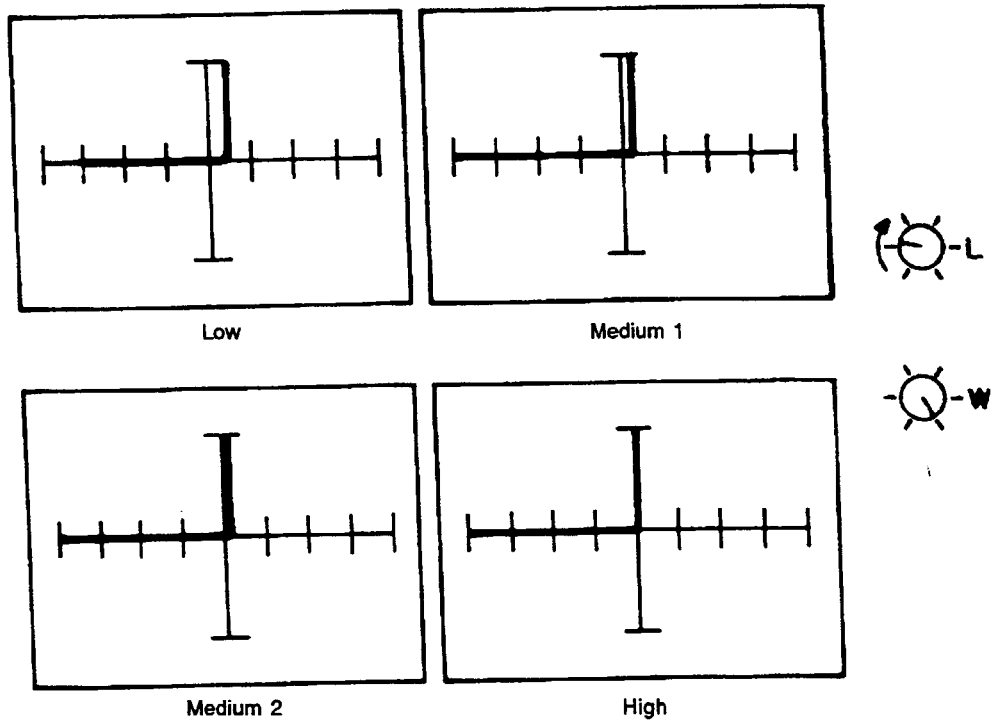

Figure 10-5. Effect of the Level Control (width = max) at 60 Hz.

## USING THE PULSE GENERATOR

The Width control can be varied over most of its range of adjustment without producing any change in the low range signature shown in Figure 10-7. This indicates a normal SCR that is switched on by any pulse that exceeds some minimum duration and remains in conduction until the anode-cathode signal changes polarity.

The best ranges for testing SCRs are the low and medium 1 ranges because those ranges have sufficient available current to produce normal action in many typical SCRs. In the medium 2 and high ranges, the maximum available current is much less than the minimum holding current of most SCRs and therefore the SCR switching characteristic cannot be observed.

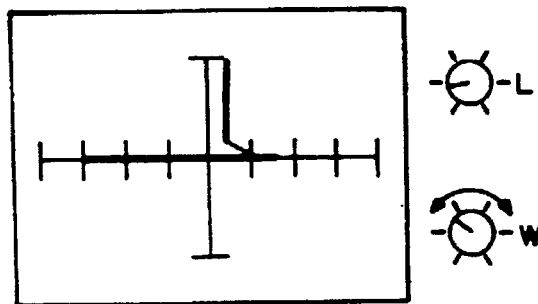

Figure 10-7. Low Range at 60 Hz.

### 10-3. TRIAC DEVICES

The triac is a bidirectional thyristor that was developed to extend the positive or negative supply of an SCR and to allow firing on either polarity with either positive or negative gate current pulses. Figure 10-8 shows the construction and symbol of a triac.

Between the gate and MT1, there are two diodes in parallel (see Figure 10-9). The resulting signatures are shown in Figure 10-10.

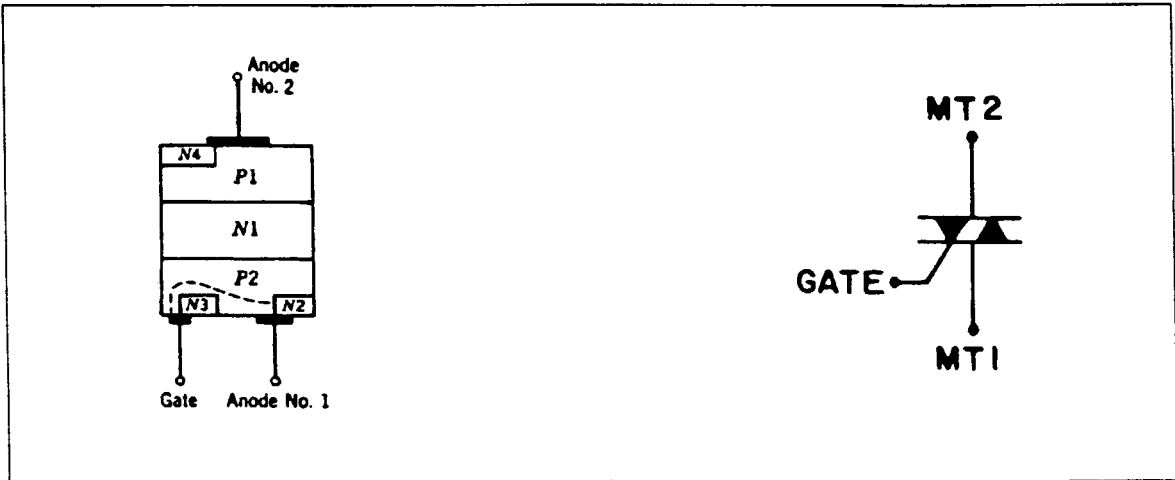

Figure 10-8. The Construction and Symbol of a Triac.

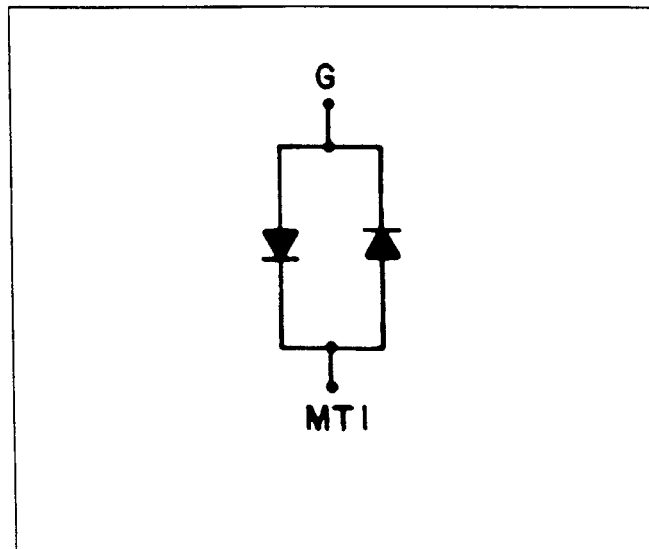

Figure 10-9. Gate-MT1 Equivalent Circuit.

USING THE PULSE GENERATOR

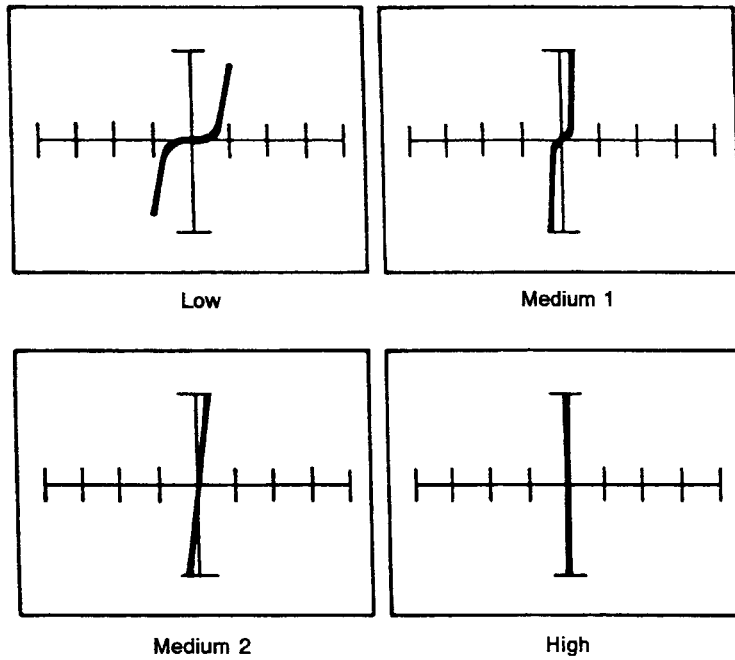

Figure 10-10. Signatures of a 2N6070 Triac at 60 Hz. Gate with MT1 as Common.

The signatures for MT2-Gate and MT2-MT1 are open circuit signatures in all ranges.

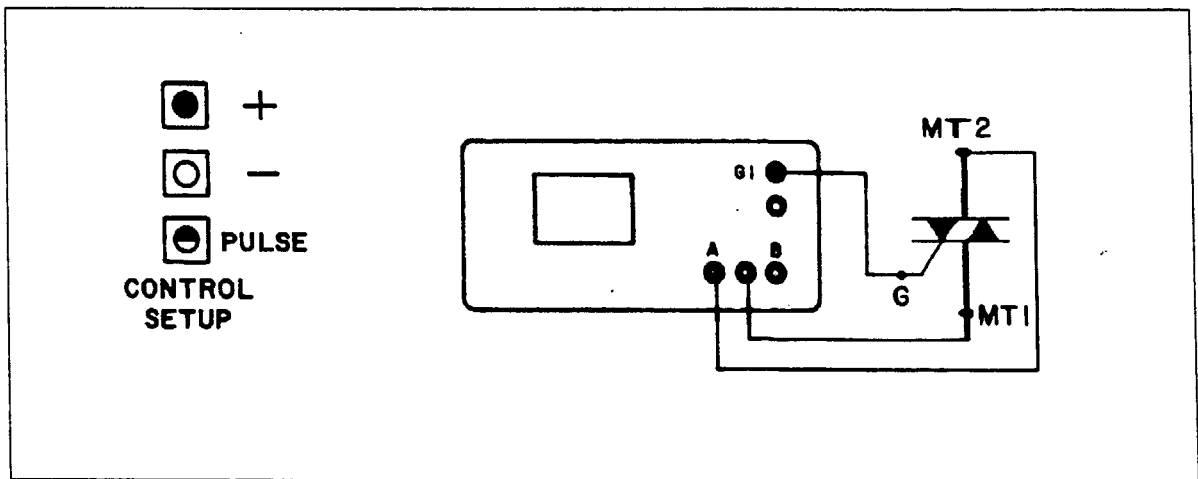

Figure 10-11. Triac Test Circuit Using the Pulse Generator.

The test circuit for a triac using the pulse generator is shown in Figure 10-11. With the Level control at zero, an open circuit trace will be displayed. As the level is increased from zero (width = max) the triac will initially turn on in the first quadrant just like an SCR. Then with a slight increase in level, the triac turns on in the third quadrant also, which produces the back-to-back diode characteristic shown in Figure 10-12. This signature demonstrates the normal bidirectional conduction that is characteristic of a triac in the on state.

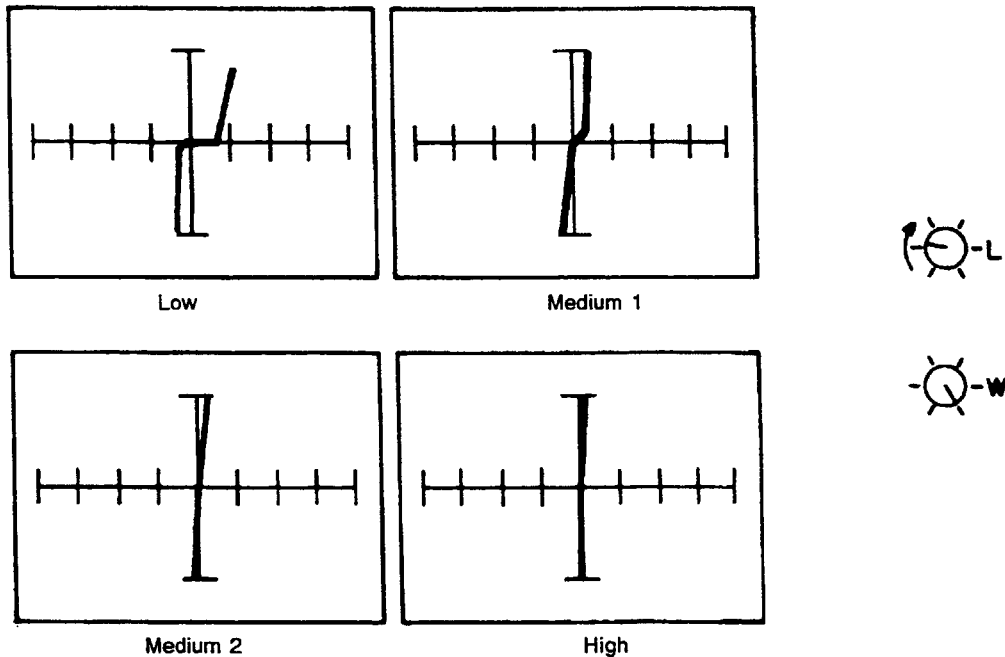

Figure 10-12. MT1-MT2 Signatures of a 2N6070 Triac with Gate Connected to the Pulse Generator at 60 Hz.

In all other ways, triacs are quite similar to SCRs. There is little change in the low range signature with various settings of the width control once the triac has turned on, which verifies that a triac will continue to conduct after a pulse fires the gate. The medium 2 and high ranges have insufficient current to detect typical triac switching action and should not be used.

#### 10-4. TRANSISTORS

Figure 10-13a shows the test circuit for an NPN transistor using the pulse generator to drive the base. With the Level control at zero (fully counterclockwise), the display shows the signature in Figure 10-13b. This signature is the same as that for the collector-base junction of an NPN Transistor in the medium 1 range. This is because the pulse generator output (G1) at zero level is equivalent to a 100Ω resistor connected to common, and 100Ω appears as a short circuit in that range.

USING THE PULSE GENERATOR

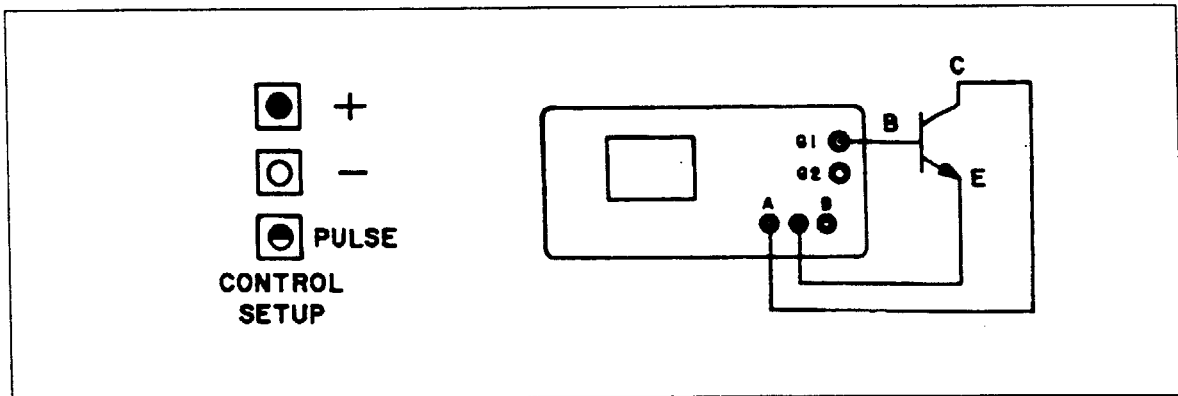

Figure 10-13a. NPN Transistor Test Circuit Using the Pulse Generator.

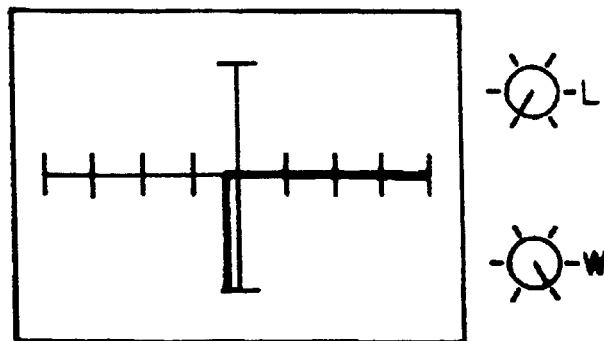

Figure 10-13b. Medium 1 Range at 60 Hz.

With the Width control turned fully clockwise, as the level is increased slowly from zero, a threshold will be reached where the "open circuit" horizontal line in the first quadrant will begin to move upward (see Figure 10-14a). This constant current signature is like that produced by a transistor curve tracer except that only one curve is shown instead of a family of curves. If the level is increased further, the horizontal portion of the signature will eventually move above the top end of the vertical axis. In the medium 1 range, the signature will then appear as a nearly vertical line indicating a low impedance.

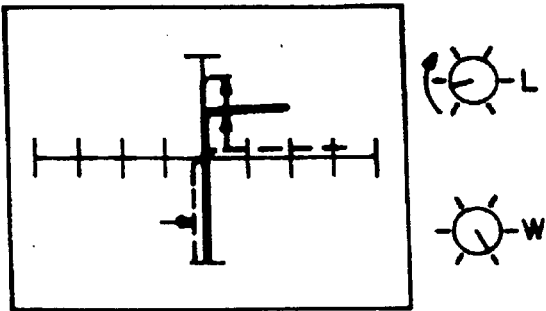

Figure 10-14a. Effect of the Level Control on NPN Test (Width = Max). Medium 1 Range at 60 Hz.

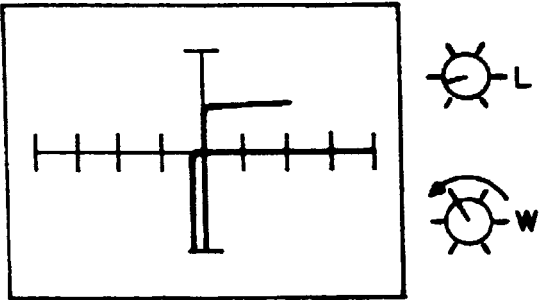

Figure 10-14b. Effect of the Width Control at Constant level on NPN Test. Medium 1 Range at 60 Hz.

The solid signature in Figure 10-14a is the result of maximum pulse stimulus. If the Width control is reduced from its maximum to about 40%, the signature shown in Figure 10-14b results. This display essentially shows the signatures of Figure 10-13b and 10-14a superimposed over one another with each one at half intensity in the first quadrant. This composite signature means that the transistor is actually switching on and off with the pulse stimulus.

PNP transistors can also be tested using the test circuit of Figure 10-15a. With the Level control at zero, the signature shown in Figure 10-15b is produced. As for the NPN transistor, this signature is the result of the collector-base junction of the transistor.

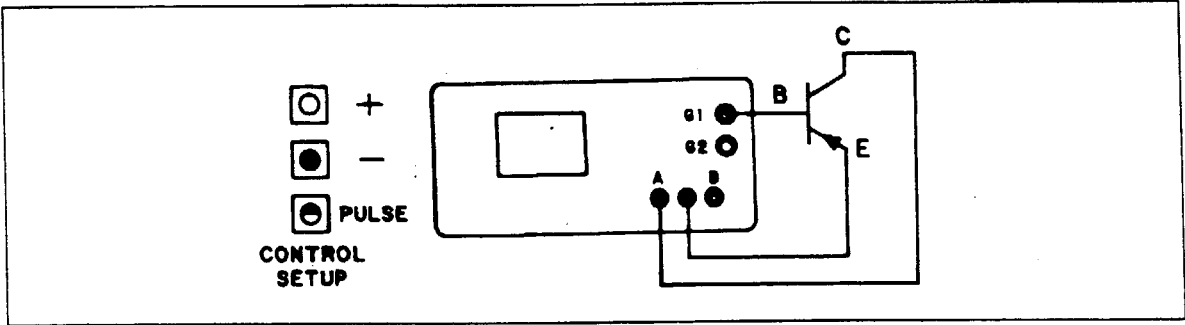

Figure 10-15a. PNP Transistor Test Circuit using the Pulse Generator.

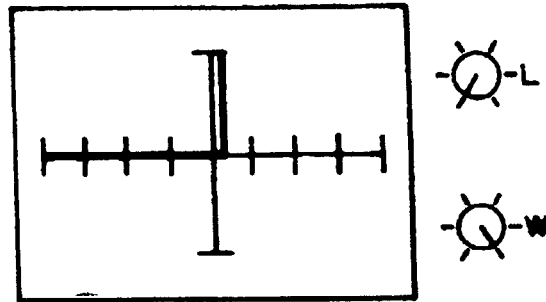

Figure 10-15b. Medium 1 Range at 60 Hz.

The discussion for the NPN transistor applies to the PNP as well except that the first and third quadrants are reversed. Figure 10-15c shows the effect of the level control (width= max) and Figure 10-15d shows the effect of the width control at a constant level.

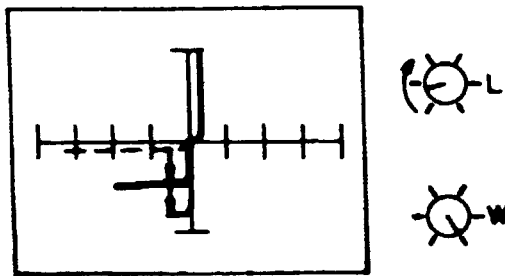

Figure 10-15c. Effect of the Level control  
(Width = Max)  
Medium 1 Range at 60 Hz.

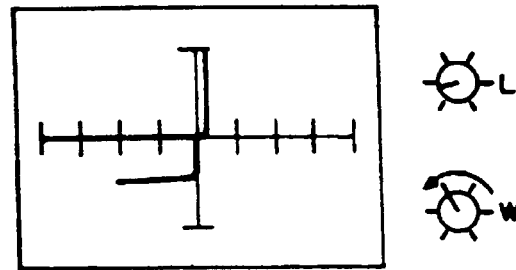

Figure 10-15d. Effect of the Width control  
at a Constant Level  
Medium 1 Range at 60 Hz.

## 10-5. OPTOCOUPLERS

The optocoupler (Optically Coupled Isolator, Photo-coupler) is a device designed for the transformation of electrical signals by utilizing optical radiant energy so as to provide coupling with electrical isolation between the input and the output.

These devices consist of a gallium arsenide infrared emitting diode and a silicon photo-device and provide high voltage isolation between separate pairs of input and output terminals. They include:

- Transistor optocouplers
- Darlington transistor optocouplers
- SCR optocouplers
- Triac optocouplers
- Photocell optocouplers



### 10-6. Transistor Optocoupler

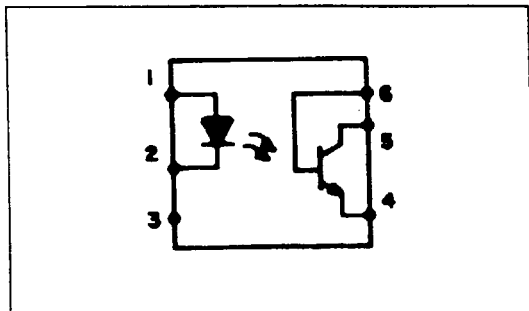

Figure 10-16. Pin Configuration of a 4N25 Transistor Optocoupler.

The 4N25 transistor optocoupler consists of a gallium arsenide infrared light emitting diode coupled with a silicon phototransistor in a dual-in-line package.

Using the 2000 in the two terminal mode, some data about optocouplers can be learned. The input LED of the optocoupler can be tested as a stand alone diode. Figure 10-16 shows the pin configuration of a 4N25. Figure 10-17 shows the signatures of the LED part of a 4N25.

In a similar manner, the output NPN transistor can be tested by examining the signatures of base-emitter (Figure 10-18) and collector-emitter (Figure 10-19).

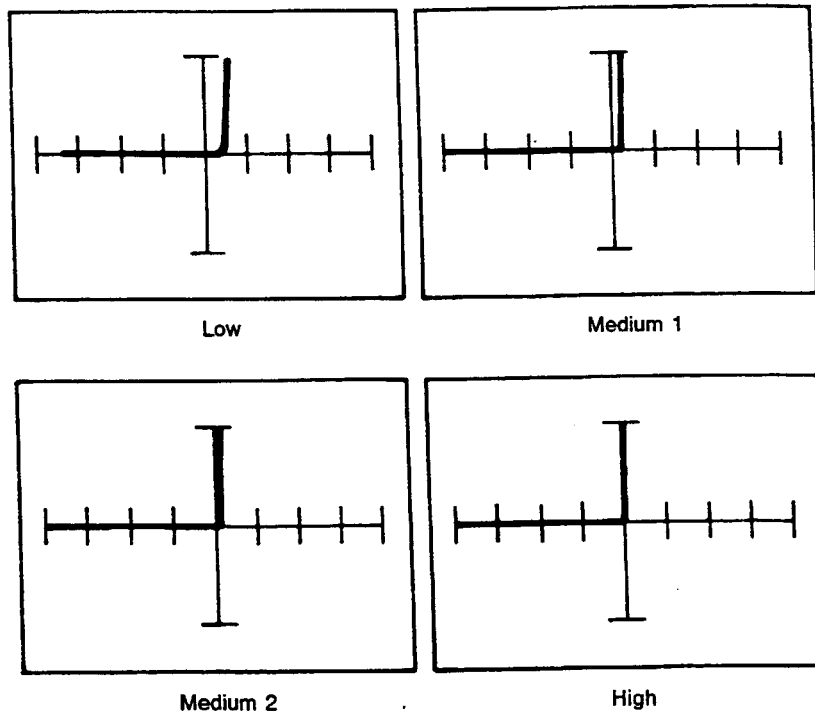

Figure 10-17. Signatures of the LED of a 4N25 at 60 Hz. Pin 1 with Pin 2 as Common.

USING THE PULSE GENERATOR

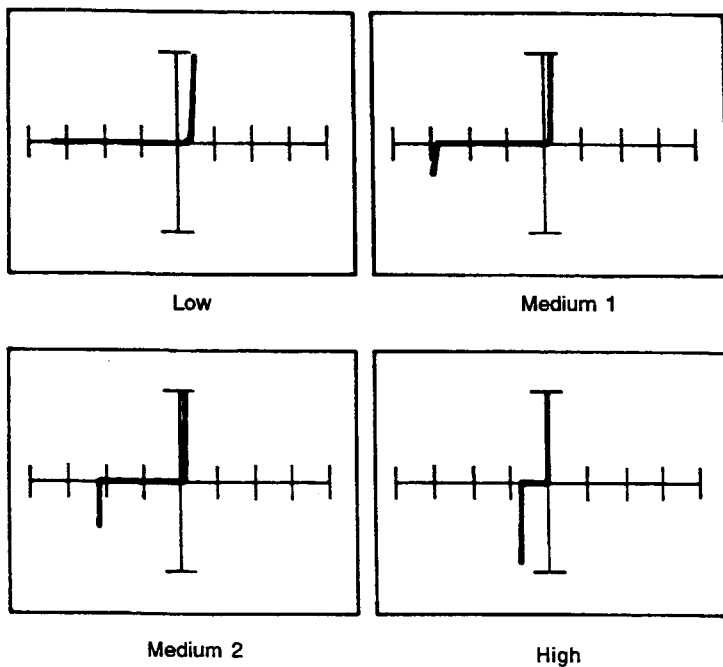

Figure 10-18. Signatures of the Base-Emitter of a 4N25 at 60 Hz. Pin 6 with Pin 4 as Common.

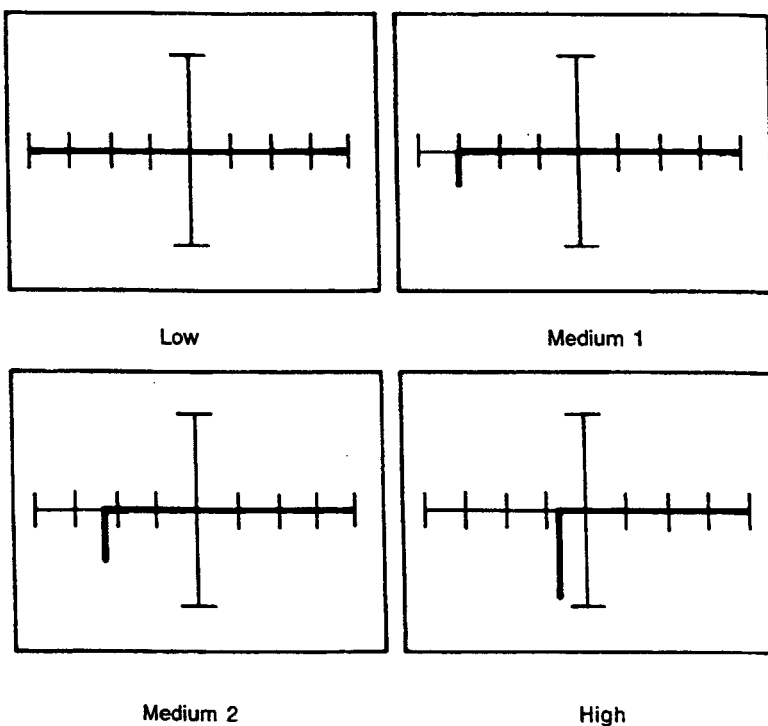

Figure 10-19. Signatures of the Collector-Emitter of a 4N25 at 60 Hz. Pin 5 with Pin 4 as Common.

These two terminal techniques can check the LED and the phototransistor, but they cannot verify the optical link between the two devices. This is why the optocoupler is uniquely suited to testing in the three terminal mode of the 2000.

Figure 10-20 shows the test circuit for an optocoupler using the pulse generator. The optocoupler shown has an NPN phototransistor as its output device, and is representative of a large percentage of the optocouplers used in modern electronic equipment. The user should note that pin 2 and pin 4 need to be connected with a jumper to establish a common point for the 2000.

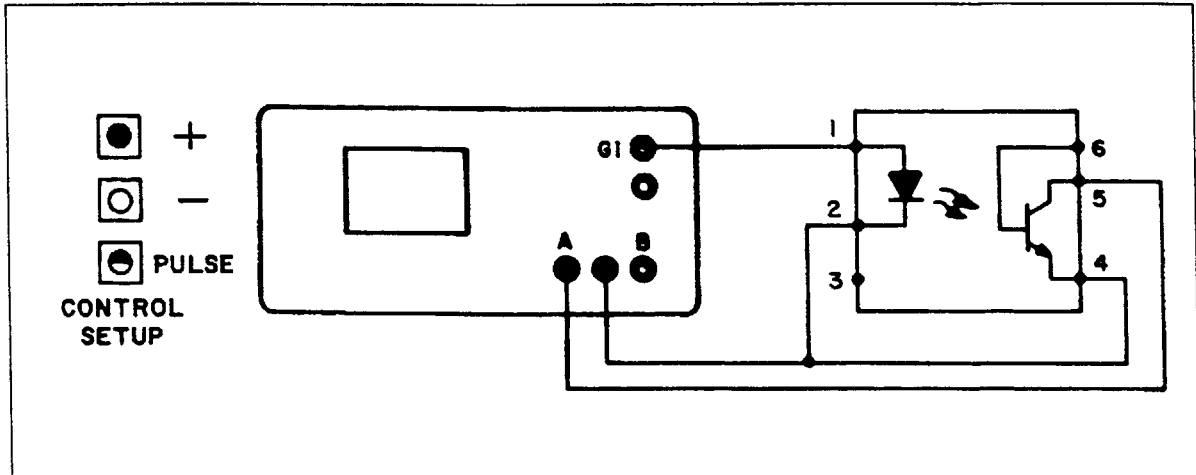

Figure 10-20. Optocoupler Test Connections Using the Pulse Generator.

Using the test circuit in Figure 10-20, if the Level control is at zero and the Width control is at maximum, the same signature is produced that was shown in Figure 10-19. This is not unexpected since there is zero drive to the LED and therefore, zero base current in the phototransistor. As the level is increased from zero, the horizontal portion of the trace in the first quadrant will move upward just like an NPN transistor driven directly by the pulse generator (see Figure 10-21a). There are two main differences between the transistor driven directly and the optocoupler transistor. First, the signature of the optocoupler in the third quadrant is different from that of the transistor with direct drive (see Figure 10-14a). Second, the sensitivity of the first quadrant signature to the position of the Level control is much lower with the optocoupler than with the transistor. This is because of the optocoupler parameter known as "current transfer ratio" (CTR) which is the ratio of collector current in the phototransistor to the forward current in the LED. CTR for common optocouplers is approximately one, whereas the corresponding parameter for the transistor alone is the forward current gain (beta) which is usually in the range from 50 to 200. This accounts for the decreased Level control sensitivity when testing optocouplers.

USING THE PULSE GENERATOR

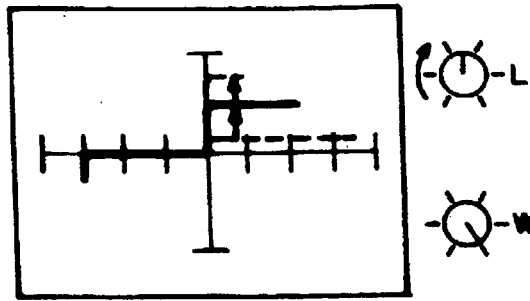

Figure 10-21a. Effect of the Level Control (Width = Max) Medium 1 Range at 60 Hz.

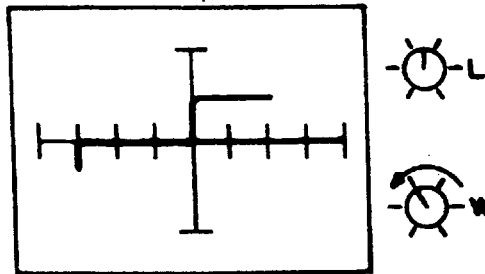

Figure 10-21b. Effect of the Width Control at a Constant Level Medium 1 Range at 60 Hz.

The optocoupler can be tested with an AC stimulus by turning the Width control to approximately 50% duty cycle. The resulting composite signature is equivalent to the signatures of Figure 10-19 (Medium 1 Range) and the 10-21a superimposed on each other. The first quadrant curves are at half intensity due to the switching action caused by the pulse generator, while the third quadrant is at full intensity because the pulse generator does not affect the signature there.

Using the second pulse generator output and the Alternate mode, two devices of the same type can be checked and compared to each other. The test connections for this method are shown in Figure 10-22. For general discussion of testing components by comparison in the two terminal mode, see Section 13.

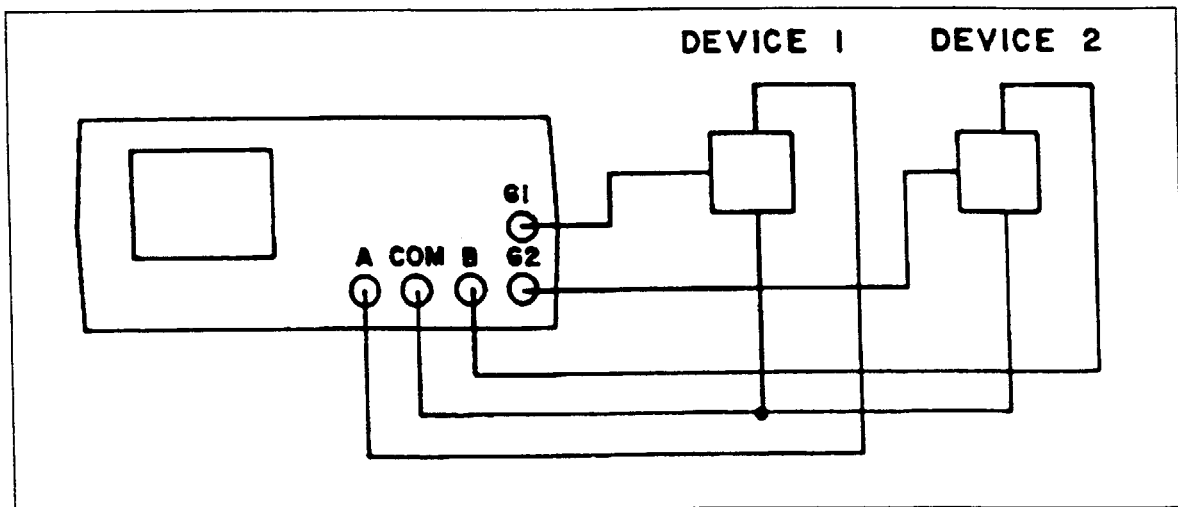

Figure 10-22. Pulse Generator Comparison Mode.

### 10-7. Darlington Transistor Optocoupler

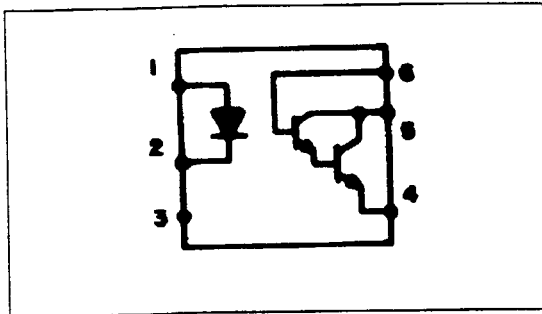

Figure 10-23. Pin Configuration of a 4N31 Darlington Transistor Optocoupler.

The Darlington transistor optocoupler consists of a gallium arsenide infrared light emitting diode coupled with a silicon photodarlington transistor in a dual-in-line package. Figure 10-23 shows the pin configuration of a 4N31 Darlington transistor optocoupler. The Darlington adds the effects of an additional stage of transistor gain to the transistor optocoupler. The two terminal test mode of a 4N31 is similar to that of 4N25 discussed in the last section, and its signatures are shown in Figures 10-24 through 10-26.

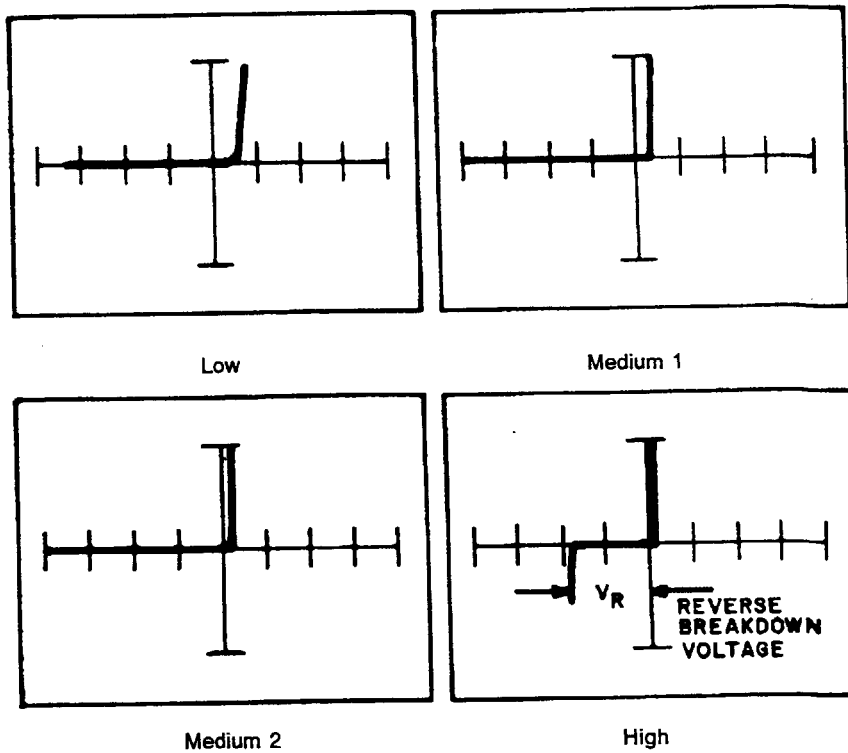

Figure 10-24. Signatures of the LED of a 4N31 at 60 Hz. Pin 1 with Pin 2 as Common.

USING THE PULSE GENERATOR

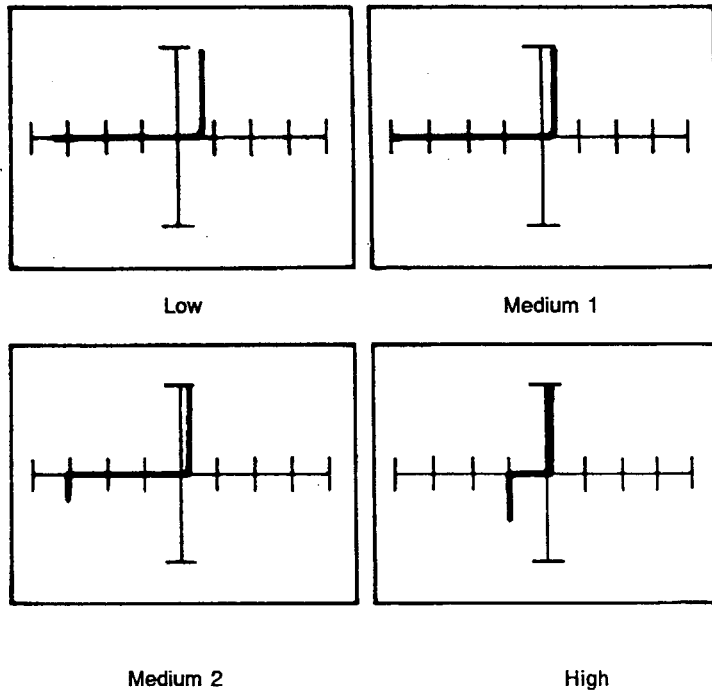

Figure 10-25. Signatures of the Base-Emitter of a 4N31 at 60 Hz. Pin 6 with Pin 4 as Common.

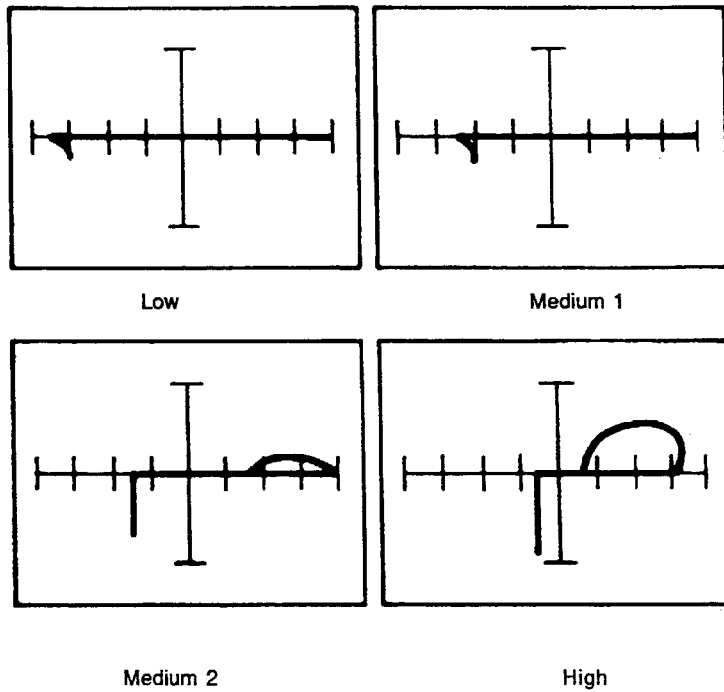

Figure 10-26. Signatures of the Collector-Emitter of a 4N31 at 60 Hz. Pin 5 with Pin 4 as Common.

The loops that appear in the medium 2 and high range signatures in Figure 10-26 are caused by a 60 Hz signal picked up by the base of the Darlington transistor.

The test circuit for a 4N31 using the pulse generator is shown in Figure 10-27, and various signatures are shown in Figure 10-28.

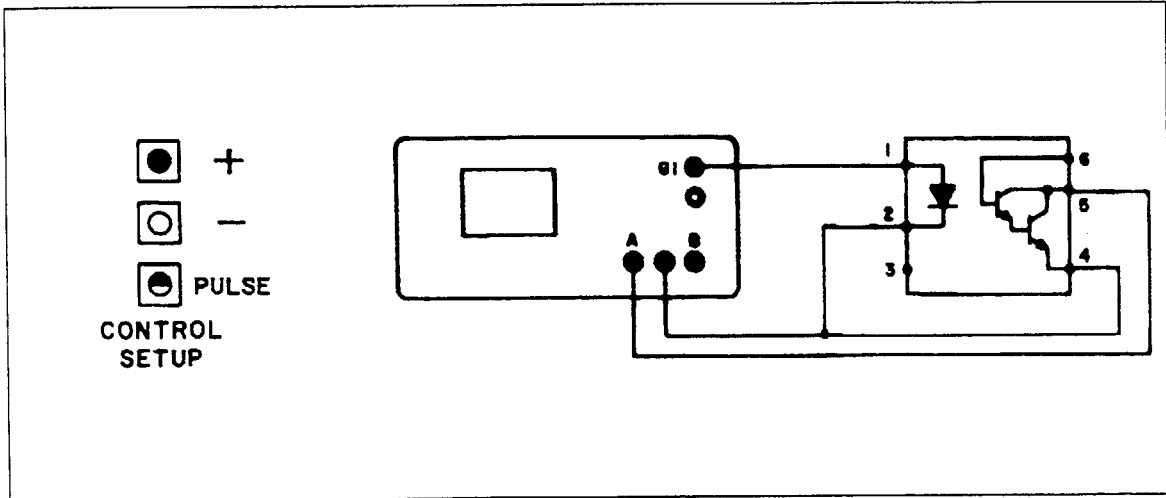

Figure 10-27. Test Circuit for a 4N31 Using the Pulse Generator.

USING THE PULSE GENERATOR

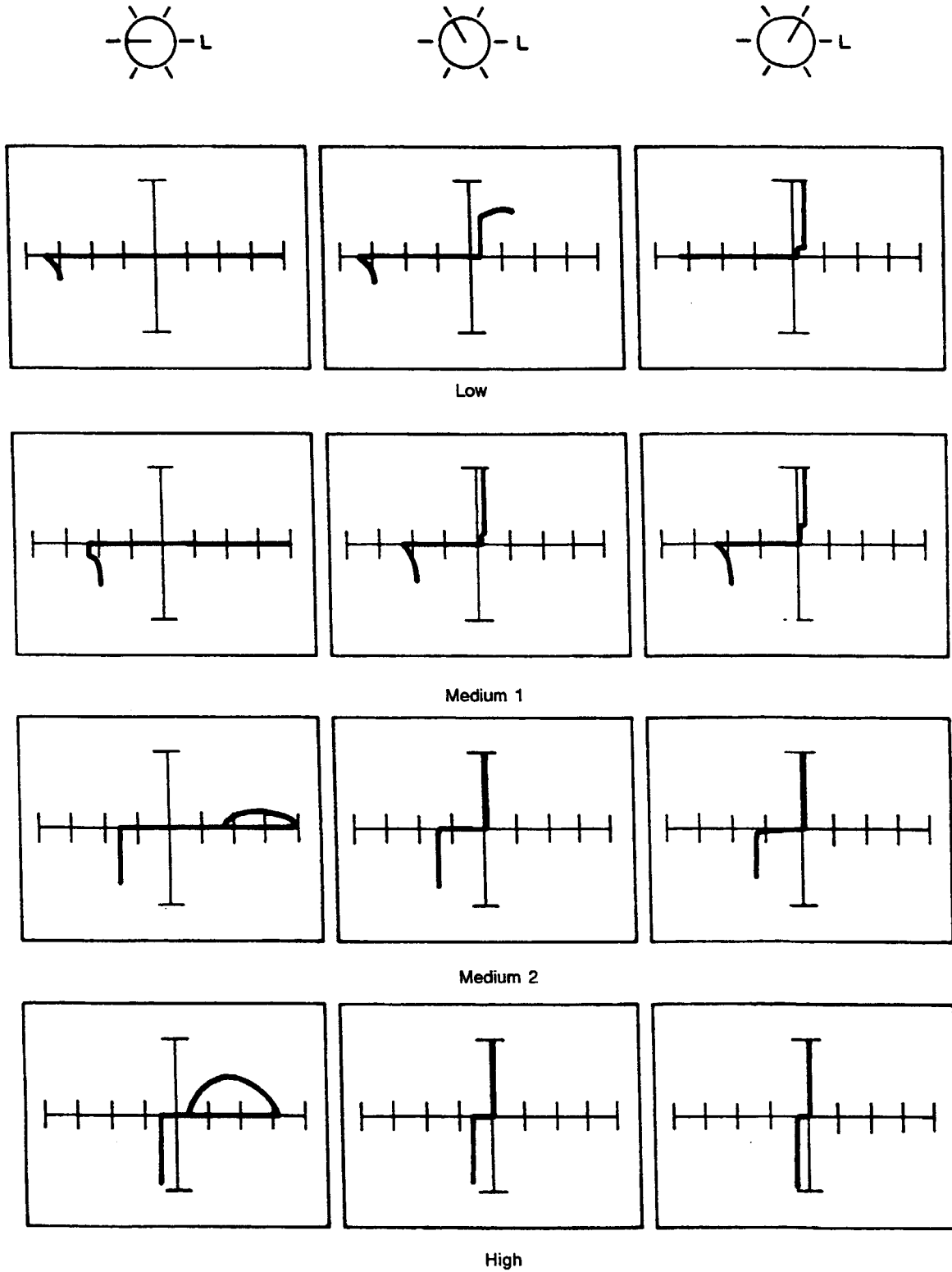

Figure 10-28. Signature Variations of a 4N31 as a Function of Pulse Level (Maximum Pulse Width) at 60 Hz.



### 10-8. SCR Optocoupler

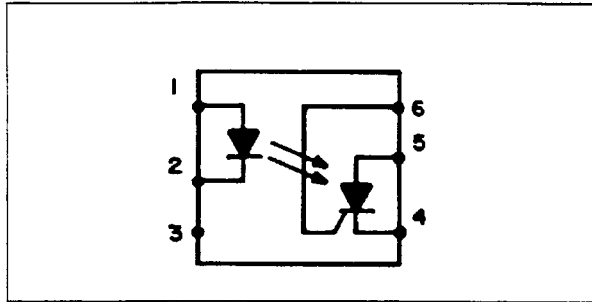

Figure 10-29. Pin Configuration of an H11C3 SCR Optocoupler.

The GE H11C3 (see Figure 10-29 for pin configuration) consists of a gallium arsenide infrared light emitting diode coupled with a light activated Silicon Controlled Rectifier in a dual-in-line package.

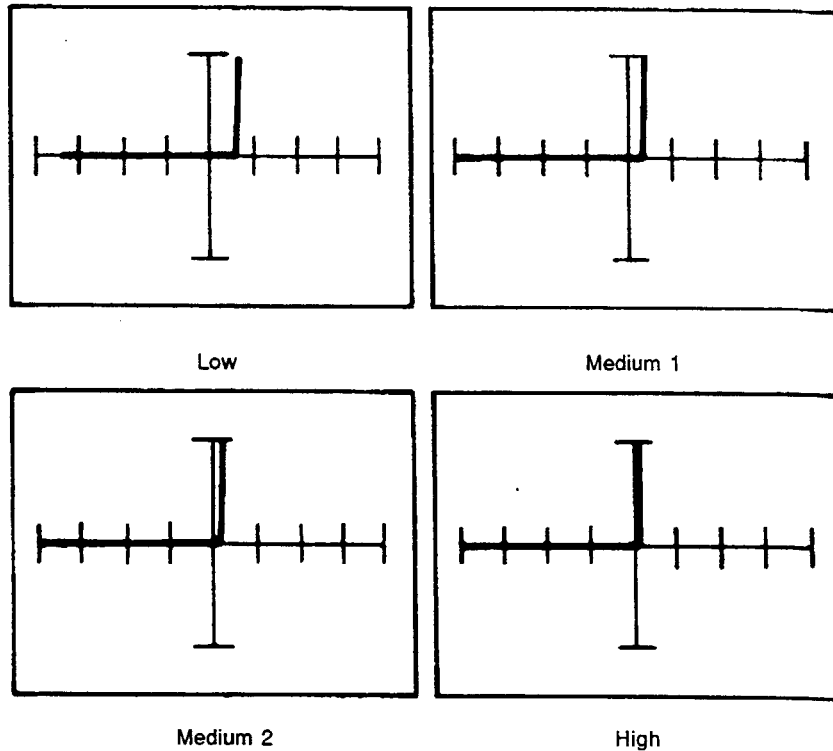

Figure 10-30. Signatures of the LED of an H11C3 at 60 Hz. Pin 1 with Pin 2 as Common.

USING THE PULSE GENERATOR

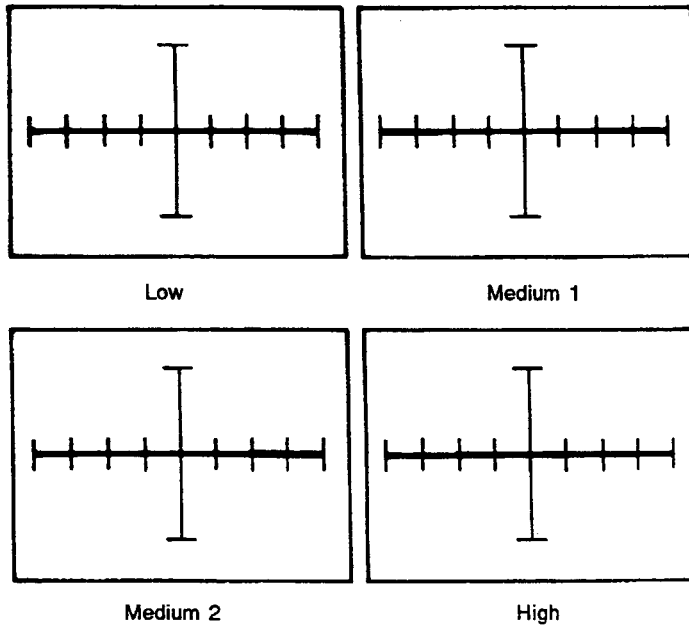

Figure 10-31. Signatures Between the Anode and Cathode of an H11C3 at 60 Hz. Pin 5 with Pin 4 as Common.

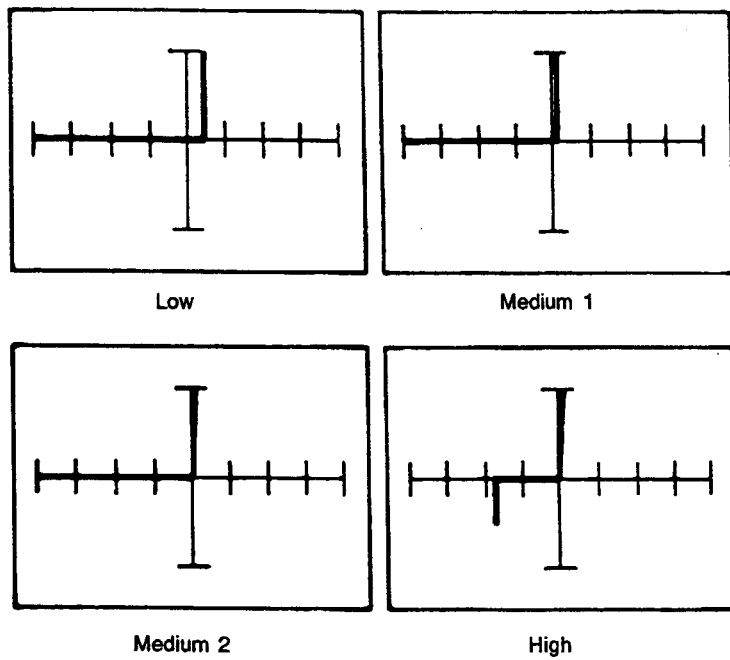

Figure 10-32. Signatures Between the Cathode and Gate of an H11C3 at 60 Hz. Pin 5 with Pin 6 as Common.

The test circuit for a H11C3 using the pulse generator is shown in Figure 10-33.

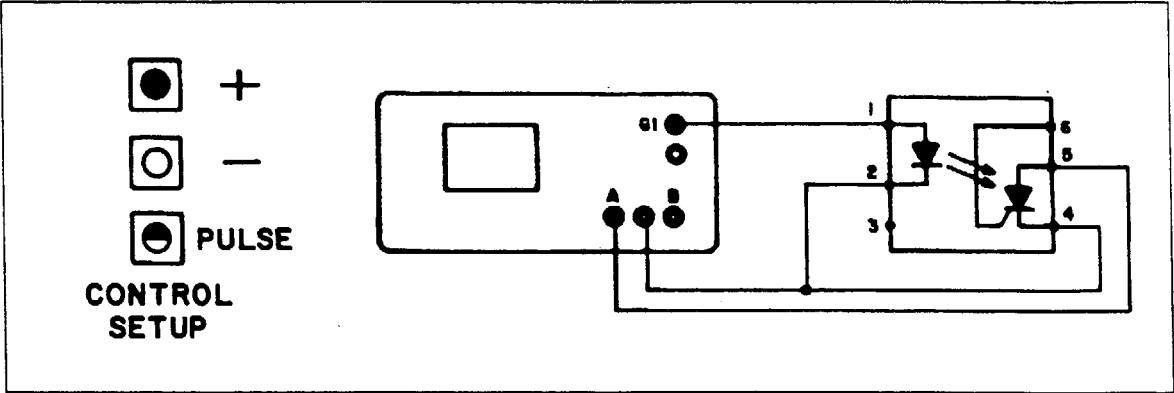

Figure 10-33. Test Circuit for an H11C3 Using the Pulse Generator.

The dynamic test signatures for an H11C3 are shown in Figure 10-34 for various settings of pulse level at maximum pulse width. Different settings of pulse level and pulse width will give different signatures.

USING THE PULSE GENERATOR

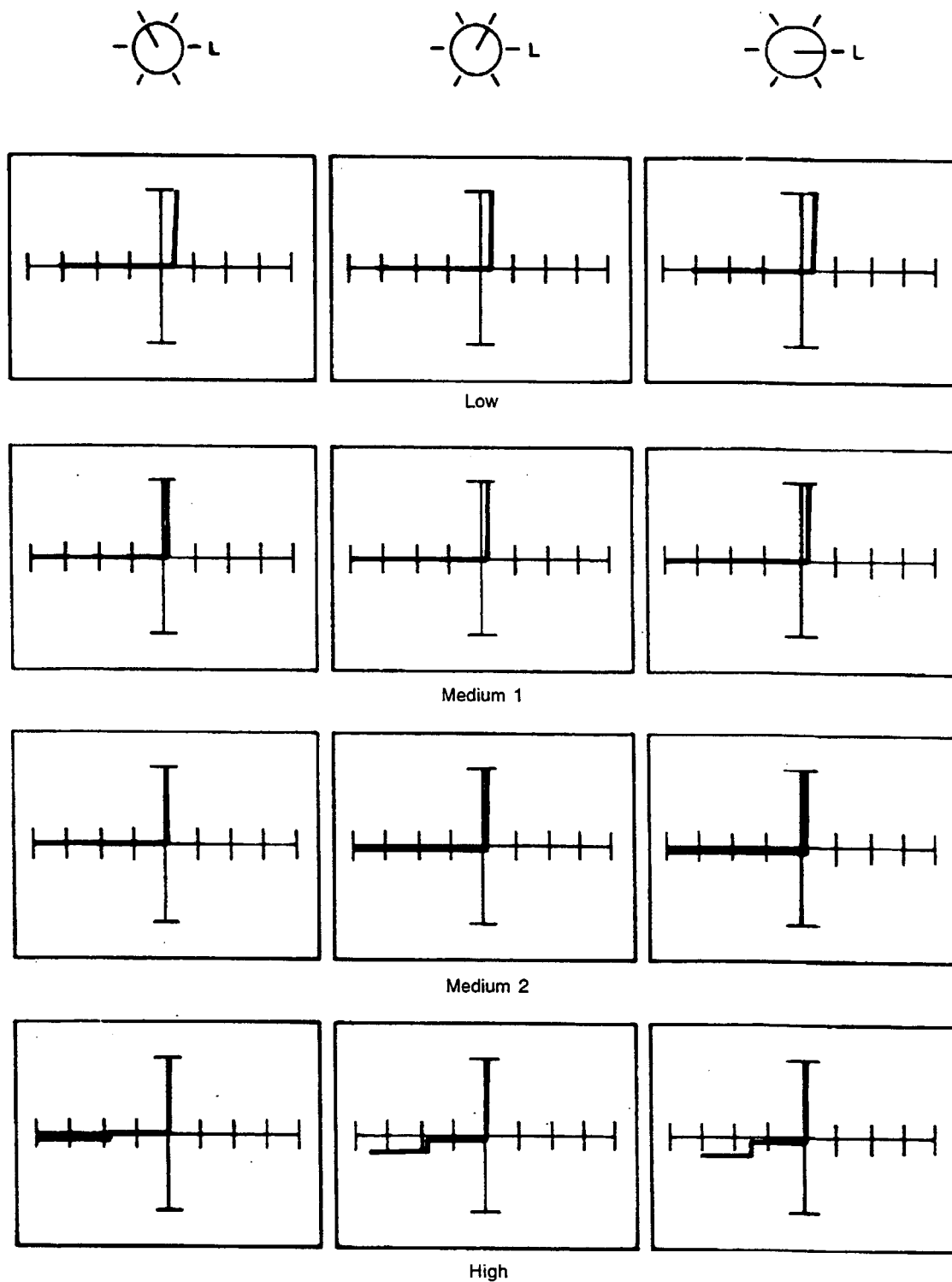

Figure 10-34. Signature Variations of an H11C3 as a Function of Pulse Level for the Maximum Pulse Width at 60 Hz.

### 10-9. Triac Optocoupler

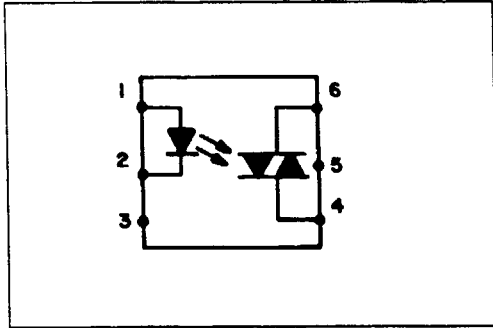

Figure 10-35. Pin Configuration of a MOC3010 Triac Optocoupler.

The Motorola MOC3010 (see Figure 10-35(for pin configuration) consists of a gallium arsenide infrared light emitting diode coupled with a light activated triac in a dual-in-line package.

The two terminal test mode signatures of a MOC3010 are shown in Figure 10-36 and Figure 10-37.

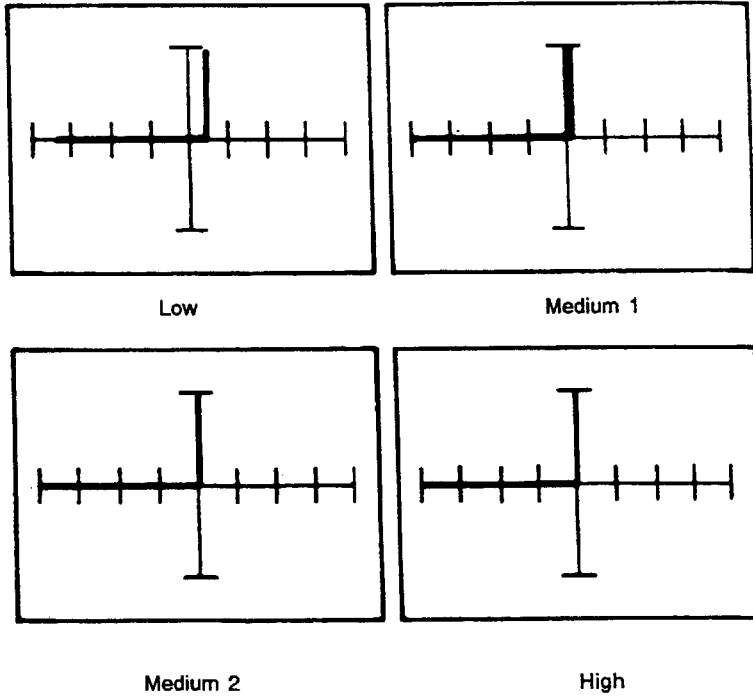

Figure 10-36. Signatures of the LED part of a MOC3010 at 60 Hz. Pin 1 with Pin 2 as Common.

USING THE PULSE GENERATOR

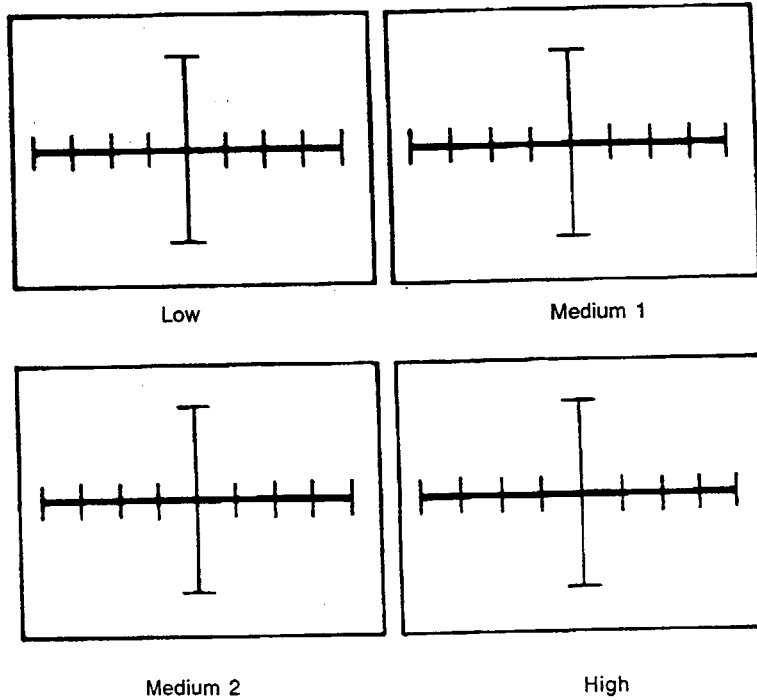

Figure 10-37. Signatures of the Triac (MOC3010) at 60 Hz. Pin 6 with Pin 5 as Common.

The test circuit for a MOC3010 using the pulse generator is shown in Figure 10-38.

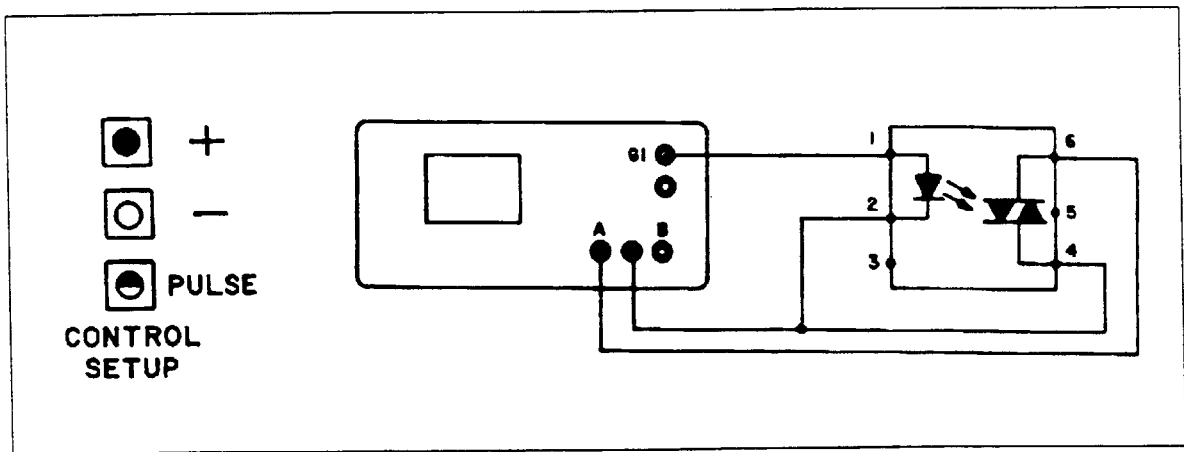

Figure 10-38. Test Circuit for a MOC3010 Triac Using the Pulse Generator.

The dynamic test signatures for an MOC3010 are shown in Figure 10-39 for various settings of the pulse level at maximum pulse width. Different settings of pulse level and pulse width will give different signatures.

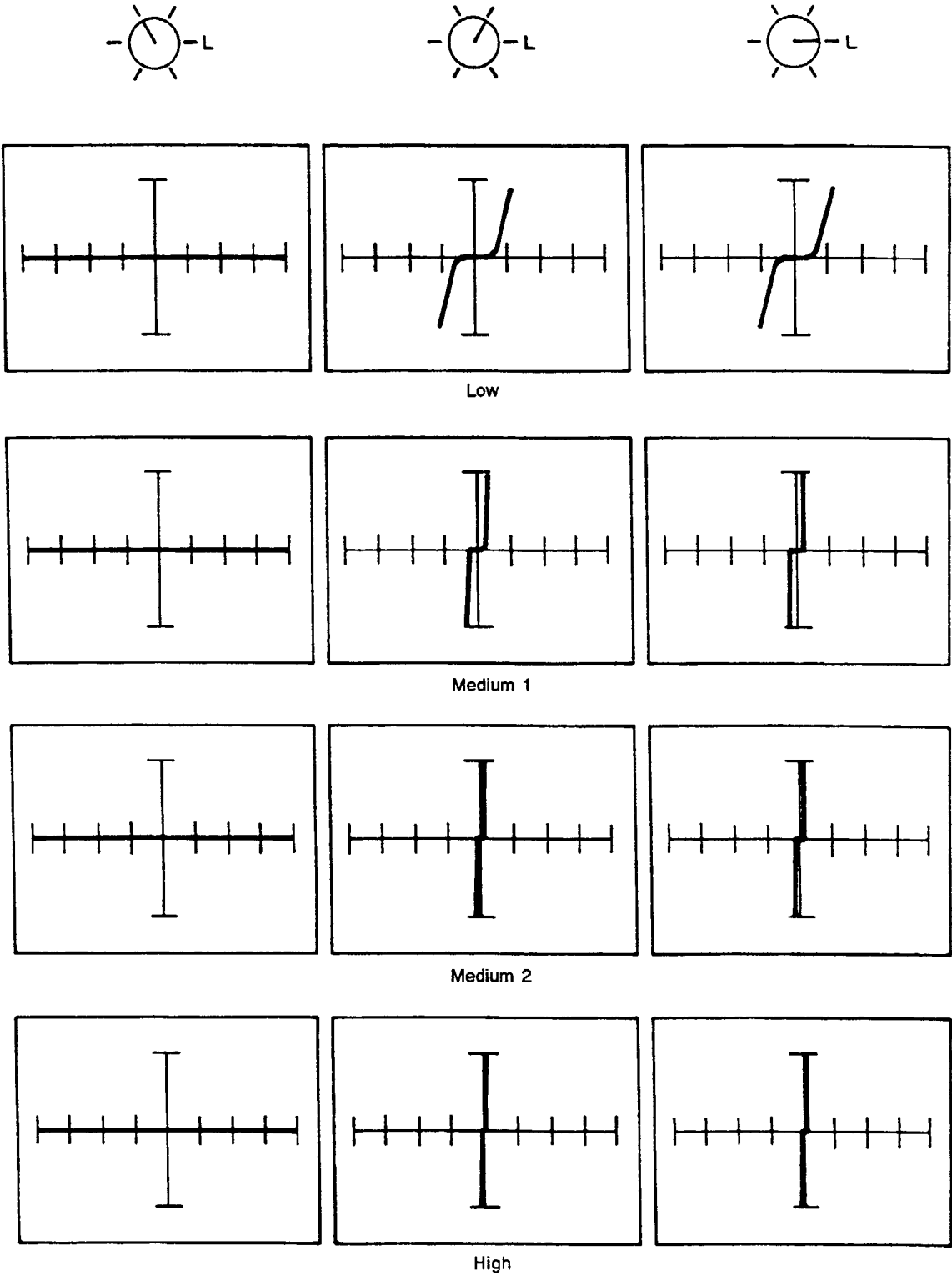

Figure 10-39. Signature Variations of an MOC3010 as a Function of the Pulse Level (Maximum Pulse Width) at 60 Hz.

### 10-10. Photocell Optocoupler

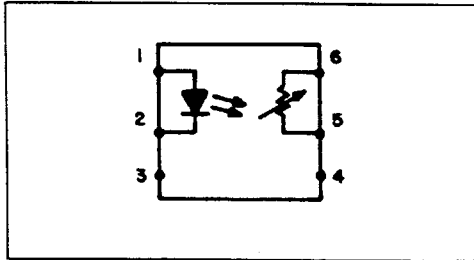

Figure 10-40. Pin Configuration of a CLM51 Photocell Optocoupler.

The Clairex CLM51 photocell optocoupler consists of a gallium arsenide infrared light emitting diode coupled to a symmetrical bilateral photoconductive cell. The cell is electrically isolated from the input. Figure 10-40 shows the pin configuration of a CLM51. The off resistance of the cell is in excess of  $1M\Omega$ , thus it appears as an open circuit to the 2000.

The two terminal mode signatures of CLM51 are shown in Figure 10-41 and Figure 10-42.

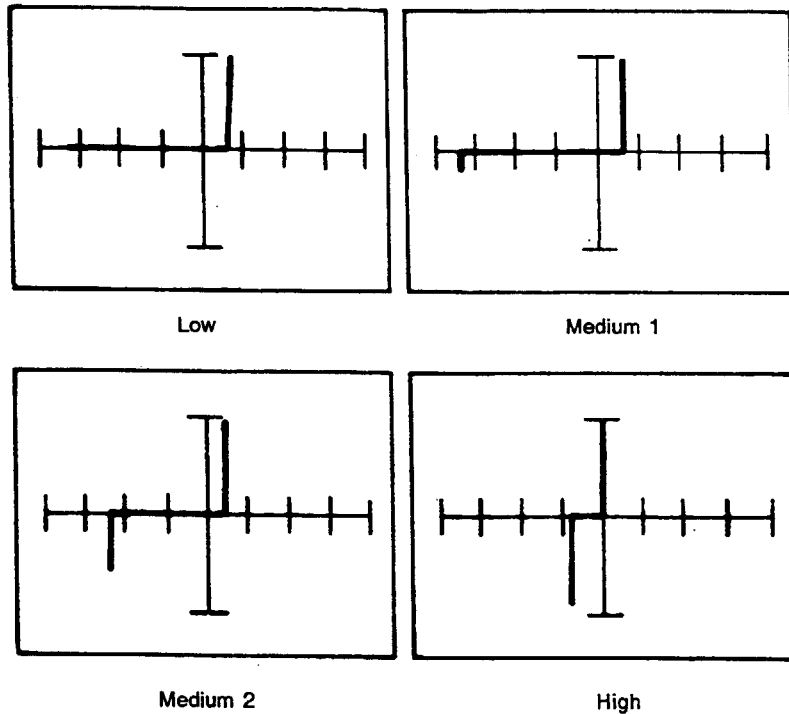

Figure 10-41. Signatures of the LED of a CLM51 at 60 Hz. Pin 1 with Pin 2 as Common.



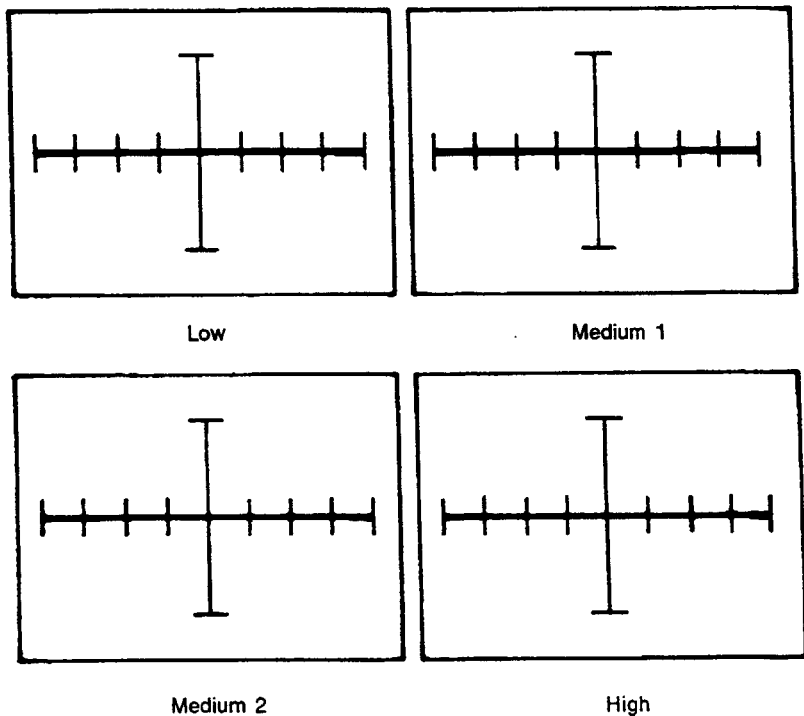

Figure 10-42. Signatures of the Cell of a CLM51 at 60 Hz. Pin 6 with Pin 5 as Common.

The test circuit of a CLM51 using the pulse generator is shown in Figure 10-43, and its signatures are shown in Figure 10-44.

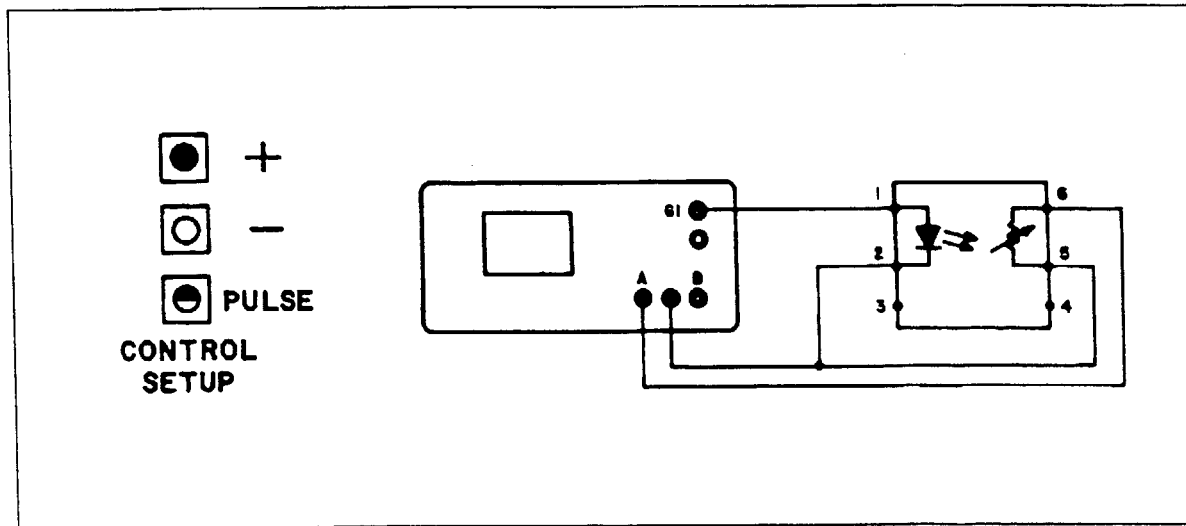
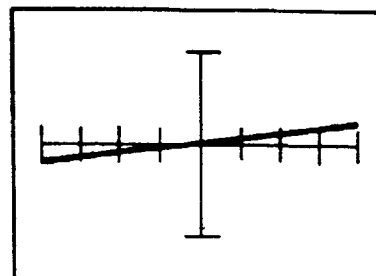
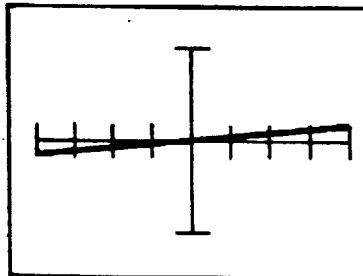
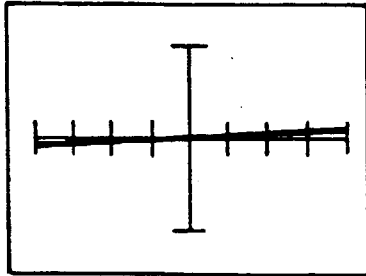
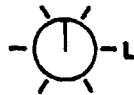
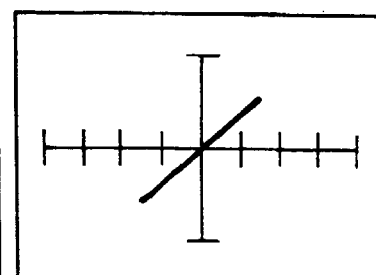
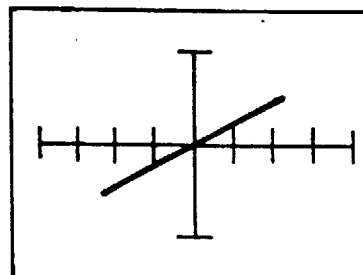
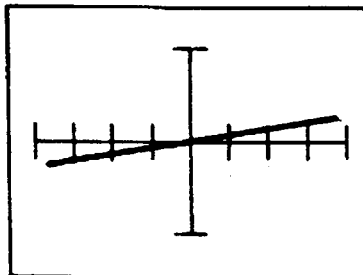

Figure 10-43. Test Circuit for a CLM51 Using the Pulse Generator.

USING THE PULSE GENERATOR



Low



Medium 1

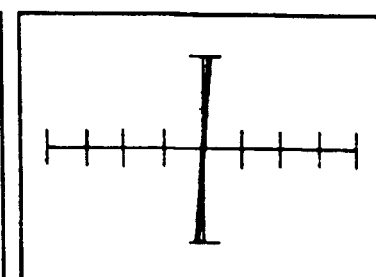
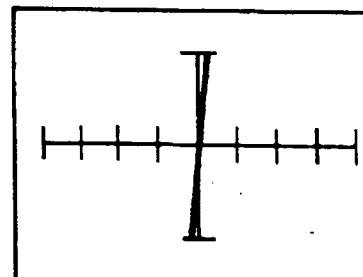
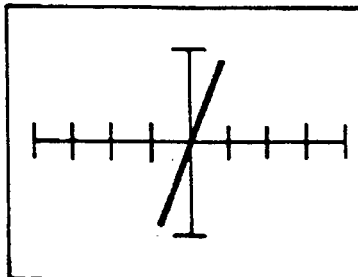

Medium 2

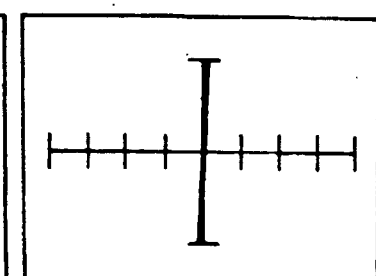
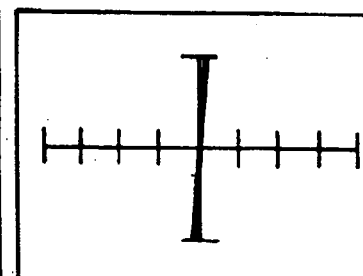
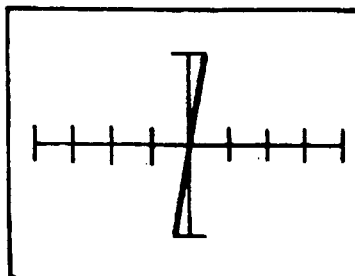

High

Figure 10-44. Signature Variations of a CLM51 as a Function of the Pulse Level (Maximum Pulse Width) at 60 Hz.

# SECTION 11

## TESTING MULTIPLE COMPONENT CIRCUITS

### 11-1. 2000 DIAGNOSTIC PRINCIPLES

The preceding sections discussed in detail the signatures for resistors, capacitors, inductors, diodes, and transistors. This section examines circuits formed by multiple components, such as diodes in series or in parallel with a resistor. It is very important for users to understand composite circuit signatures prior to printed circuit board level troubleshooting. Based on the information contained in the previous sections, the following diagnostics are presented in Table 11-1.

**Table 11-1**  
**Diagnostic Table**

COMPONENTS	RANGE	SIGNATURES DESCRIPTION
Open circuit	All	Horizontal line
Short circuit	All	Vertical line
Resistor	All	Straight diagonal line
Diode	All	"L" shape
Capacitor	All	Ellipse or circle
Inductor	All	Ellipse or circle

### 11-2. DIODE/RESISTOR CIRCUITS

When testing diode/resistor circuits, the best signatures on the 2000 depend on whether the diode is in series or in parallel with a resistor, the value of the resistor, and the selected range.

#### 11-3. Diode in Parallel with a Resistor

Figure 11-1 shows the effect of various resistance values on a diode (1N4001) signature with the low range selected on the 2000. When the value of the resistor is over 1K $\Omega$ , it contributes little to the signature, and the 2000 displays mainly the diode effect. On the other hand, resistance of less than 5 $\Omega$  dominates the signature.

TESTING MULTIPLE COMPONENT CIRCUITS

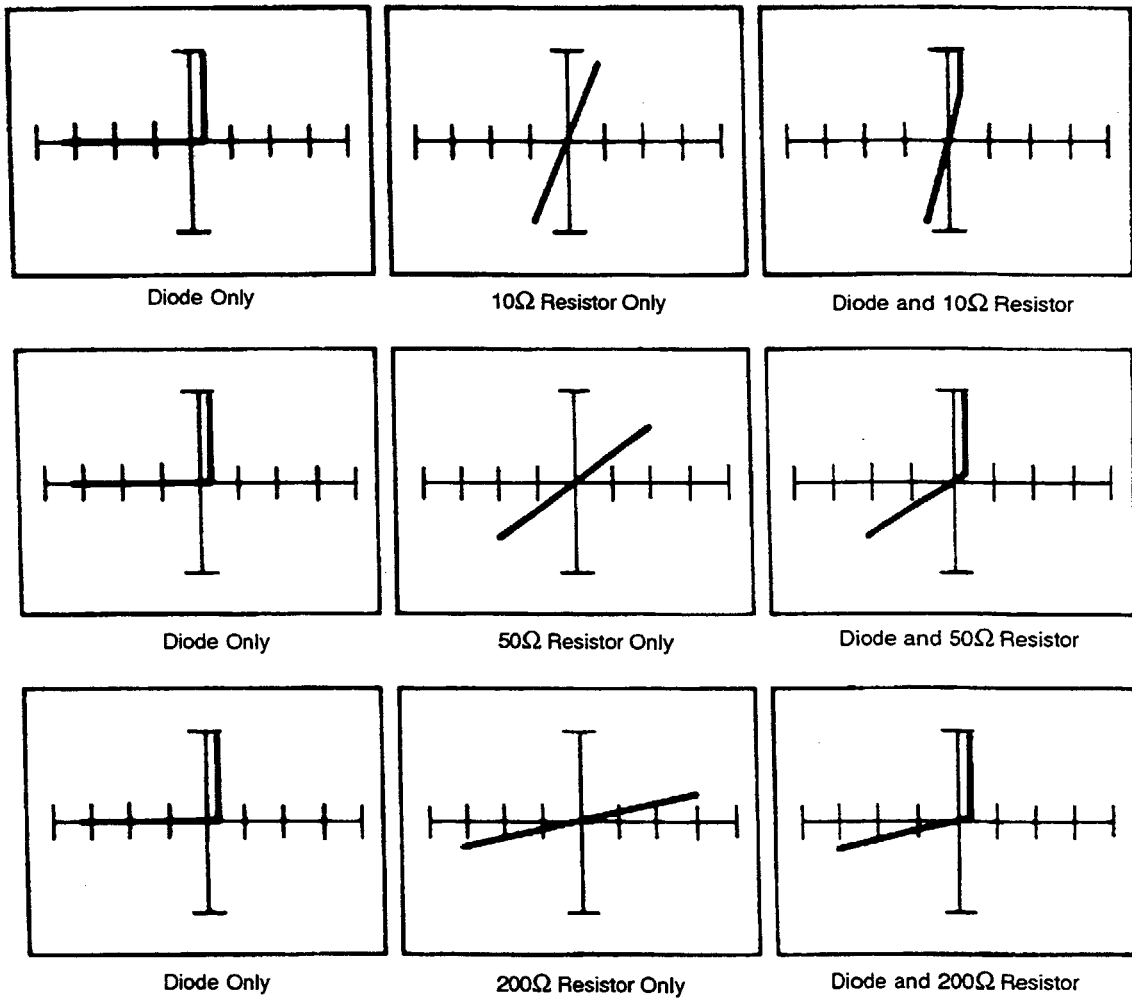

Figure 11-1. Parallel Diode/Resistor Signatures-Low Range.

Figure 11-2 shows the signatures for various resistors in parallel with a diode in the medium 1 range of the 2000. Resistors with values greater than 50KΩ have insignificant influence on the diode signature. For resistors of less than 500Ω, the signature is dominated by the resistor, while the diode contributes little. The medium 2 and high range of the 2000 provide signatures similar to that of the medium 1 range, except that they cover higher resistance values.

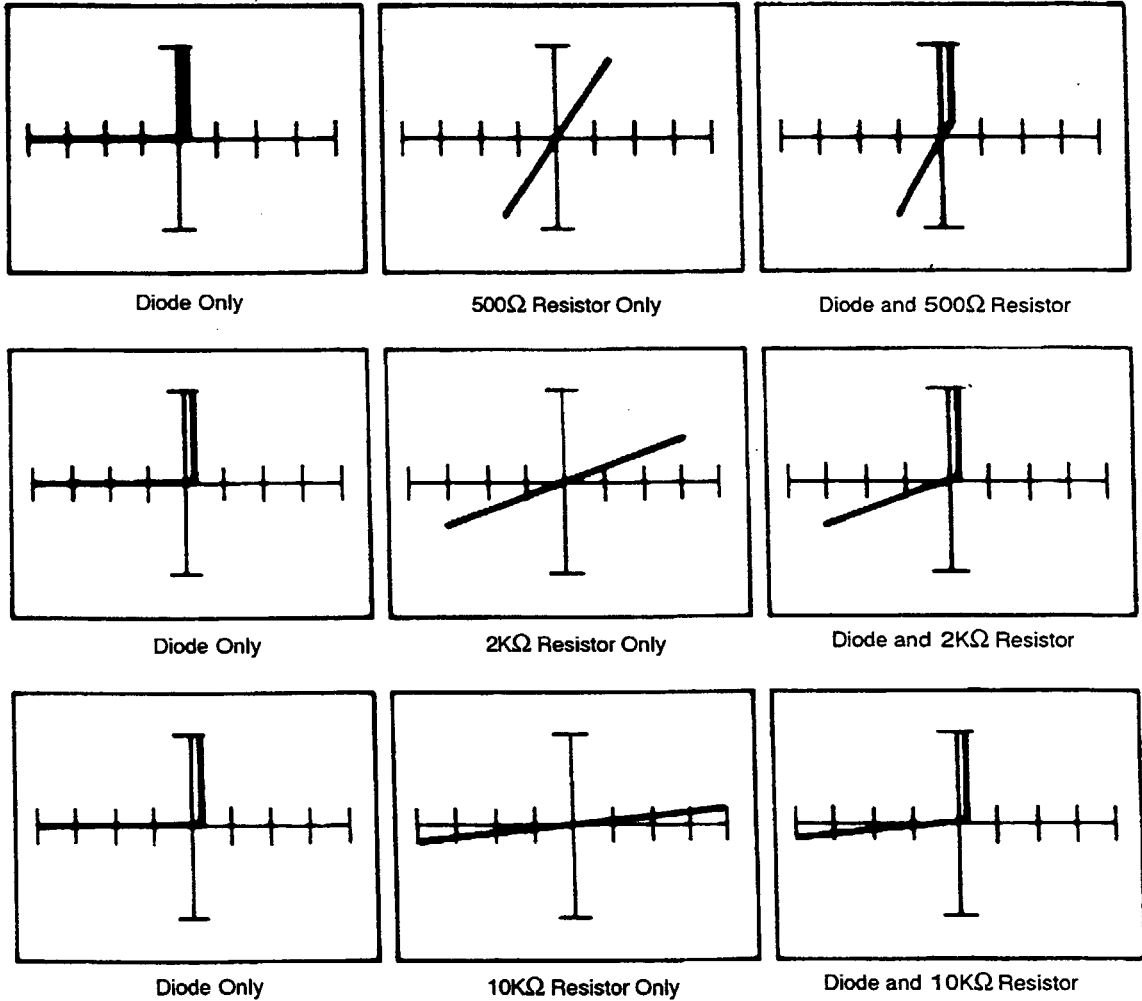

Figure 11-2. Parallel Diode/Resistor Signatures-Medium 1 Range.

### 11-4. Diode in Series with a Resistor

When the diode is forward biased, it is in a low impedance state and the 2000 displays only the resistor. However, if the diode is reverse biased, the series circuit appears as an open circuit to the 2000. Figure 11-3 shows the equivalent circuits for the diode resistor series combination when forward and reversed biased.

Figures 11-4, 11-5, 11-6 and 11-7 show the 2000 signatures for various values of resistors in series with a diode while operating the 2000 in low, medium 1, medium 2, and high range.

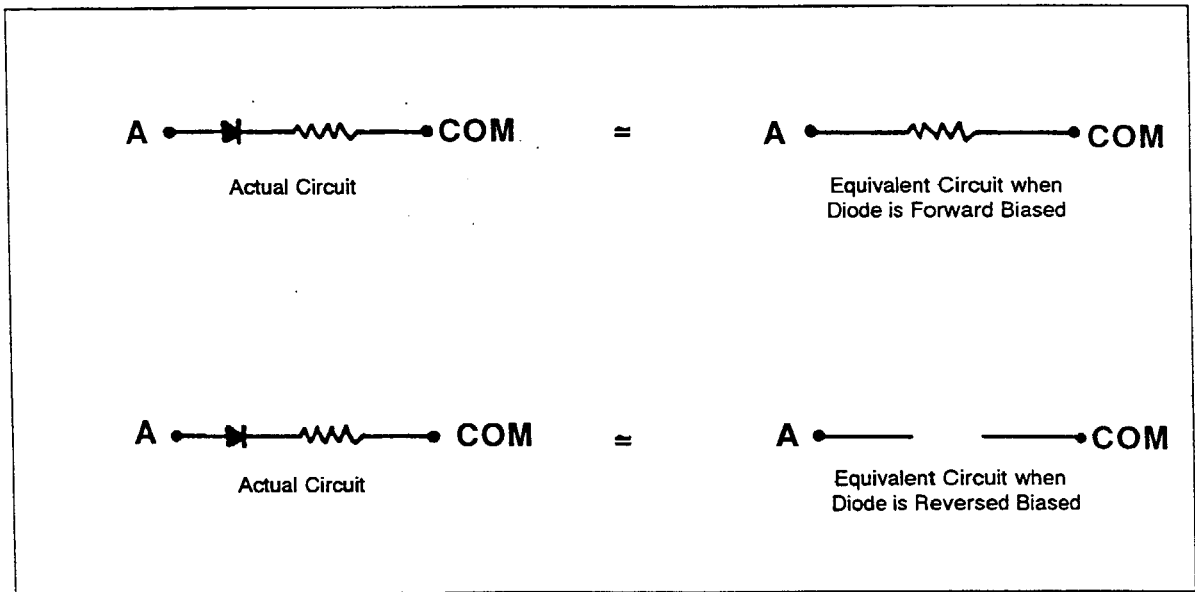

Figure 11-3. Diode/Resistor Equivalent Circuits.

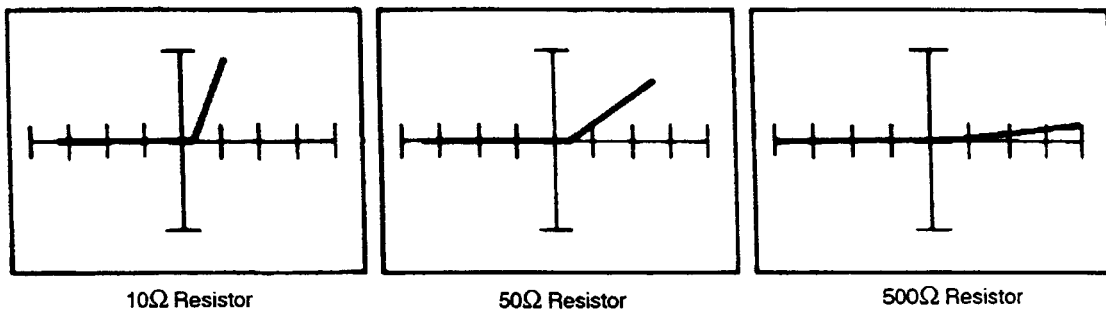

Figure 11-4. Low Range Signatures for Various Resistors and Series Diode at 60 Hz.

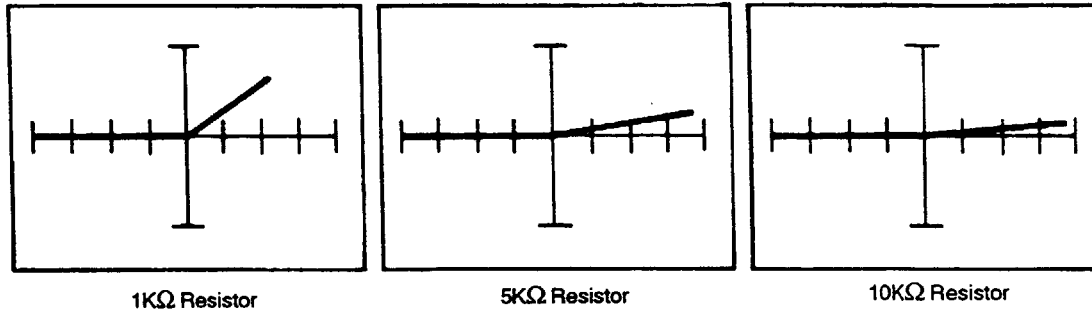

Figure 11-5. Medium 1 Range Signatures for Various Resistors and Series Diode at 60 Hz.

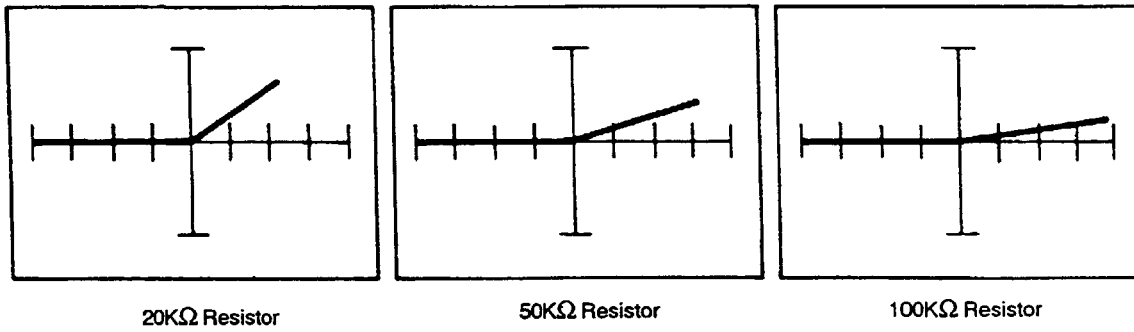

Figure 11-6. Medium 2 Range Signatures for Various Resistors and Series Diode at 60 Hz.

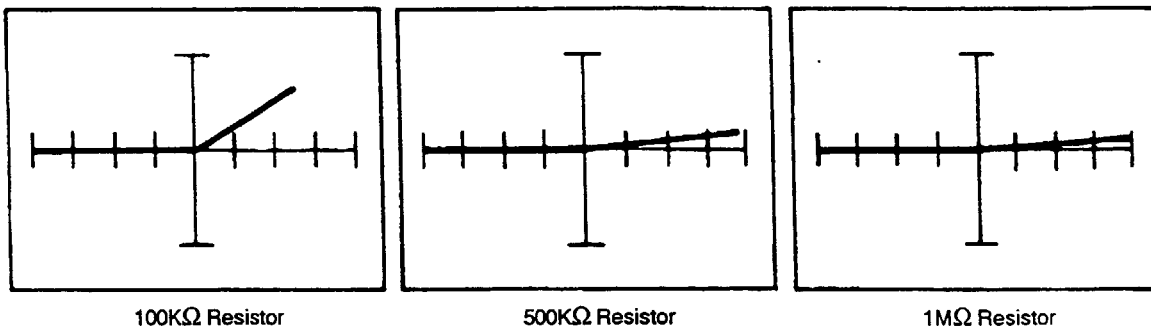

Figure 11-7. High Range Signatures for Various Resistors and Series Diode at 60 Hz.

## 11-5. DIODE AND CAPACITOR PARALLEL COMBINATION

Figure 11-8 shows signatures for a  $.1\mu\text{F}$  capacitor in parallel with a 1N4001 diode tested at 60 Hz and 2000 Hz. At 60 Hz, the low range is not able to detect the  $.1\mu\text{F}$  capacitor. The 2000 Hz test frequency is able to detect the  $.1\mu\text{F}$  capacitor in the low range. However, the diode effect is not detected at 2000 Hz in the medium 2 and high ranges.

Figures 11-9 and 11-10 show the signatures of  $1\mu\text{F}$  and  $100\mu\text{F}$  capacitors respectively in parallel with a 1N4001 diode tested at 60 Hz and 2000 Hz. For capacitors with a value larger than  $100\mu\text{F}$ , the diode effect will no longer be detected in the medium 1, medium 2 and high ranges for all test frequencies.



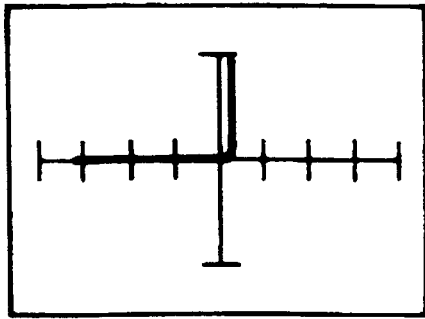

Low, .1 $\mu$ F, 60 Hz

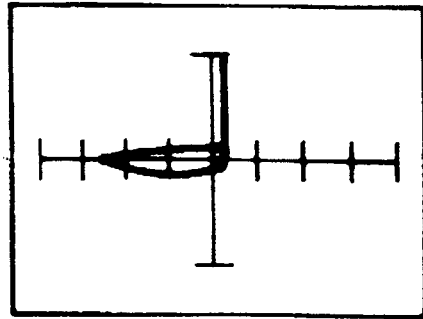

Low, .1 $\mu$ F, 2000 Hz

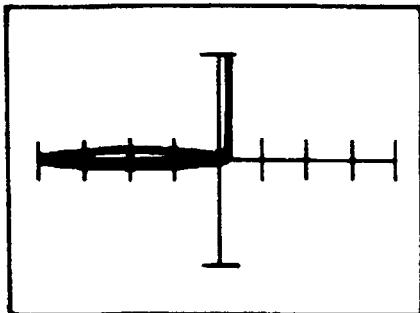

Medium 1, .1 $\mu$ F, 60 Hz

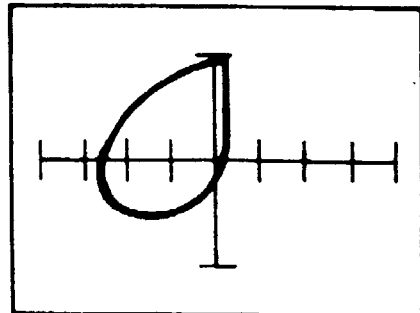

Medium 1, .1 $\mu$ F, 2000 Hz

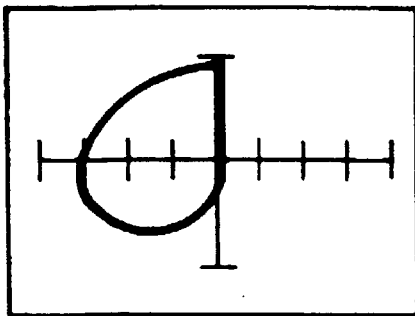

Medium 2, .1 $\mu$ F, 60 Hz

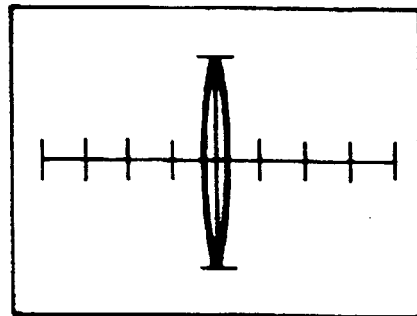

Medium 2, .1 $\mu$ F, 2000 Hz

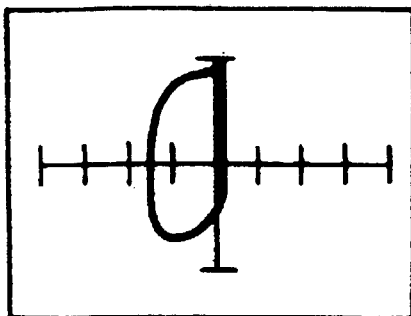

High, .1 $\mu$ F, 60 Hz

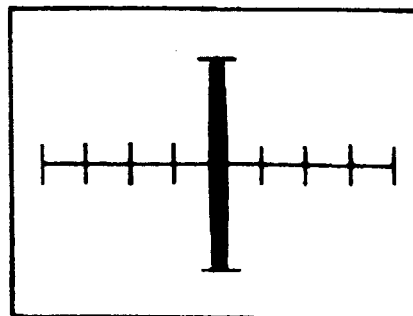

High, .1 $\mu$ F, 2000 Hz

Figure 11-8. Signatures of .1 $\mu$ F Capacitor In Parallel with 1N4001 Diode Tested at 60 Hz and 2000 Hz.

TESTING MULTIPLE COMPONENT CIRCUITS

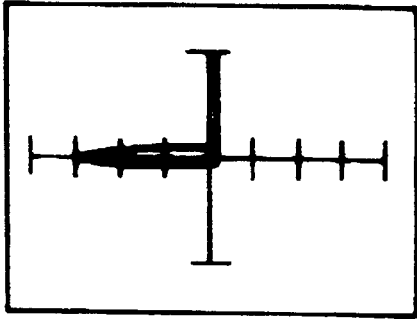

Low, 1µF, 60 Hz

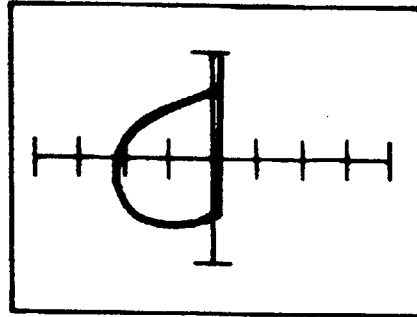

Low, 1µF, 2000 Hz

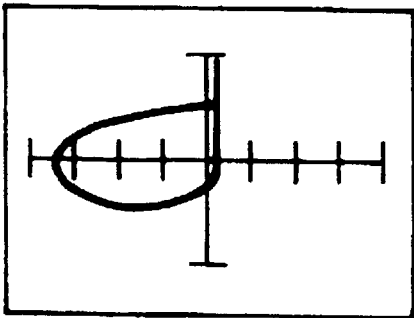

Medium 1, 1µF, 60 Hz

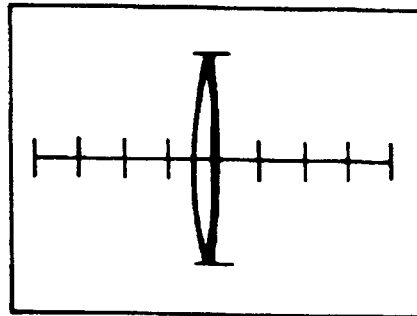

Medium 1, 1µF, 2000 Hz

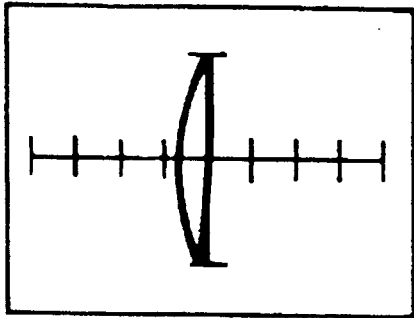

Medium 2, 1µF, 60 Hz

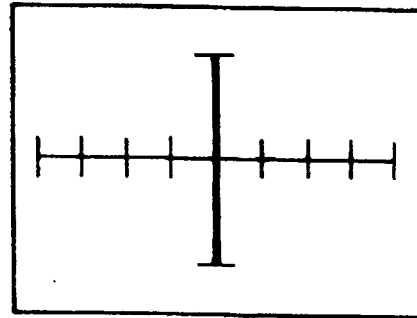

Medium 2, 1µF, 2000 Hz

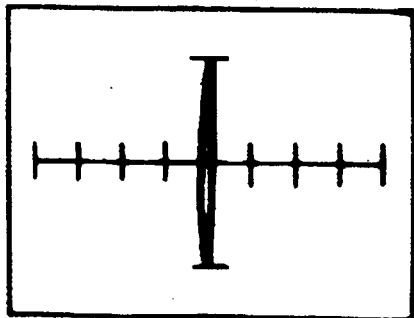

High, 1µF, 60 Hz

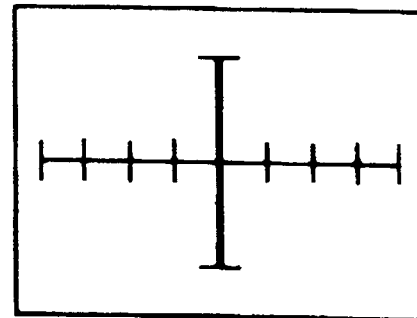

High, 1µF, 2000 Hz

Figure 11-9. Signatures of 1µF Capacitor in Parallel with 1N4001 Diode Tested at 60 Hz and 2000 Hz.

TESTING MULTIPLE COMPONENT CIRCUITS

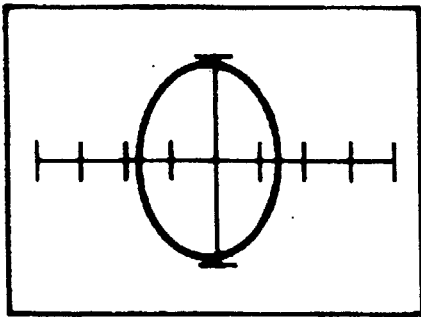

Low, 100µF, 60 Hz

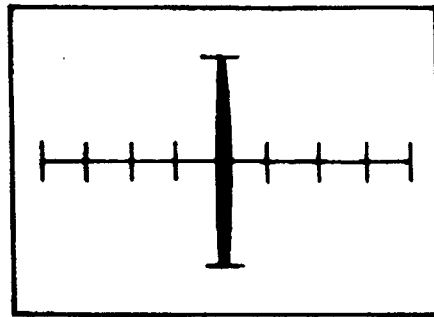

Low, 100µF, 2000 Hz

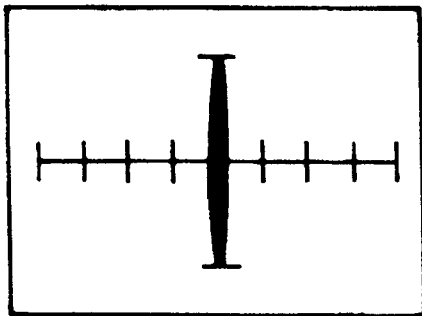

Medium 1, 100µF, 60 Hz

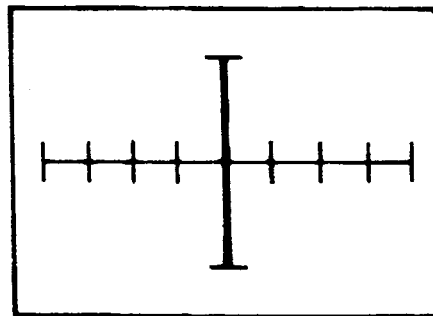

Medium 1, 100µF, 2000 Hz

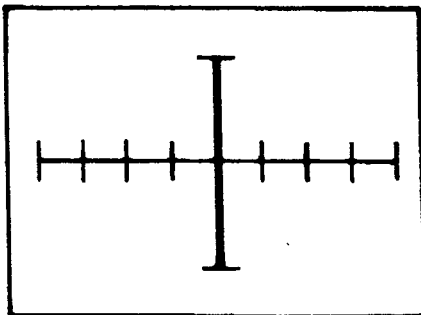

Medium 2, 100µF, 60 Hz

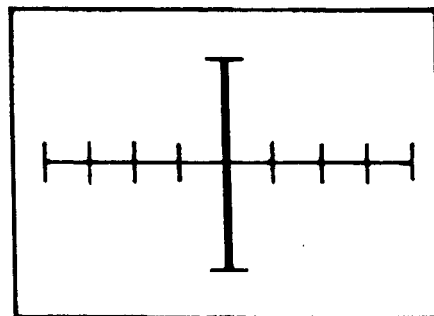

Medium 2, 100µF, 2000 Hz

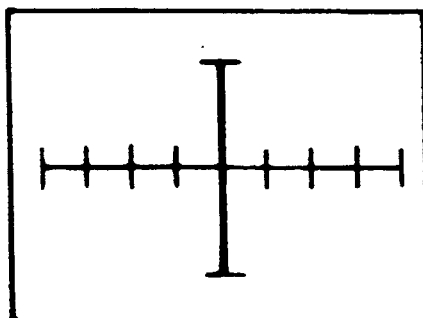

High, 100µF, 60 Hz

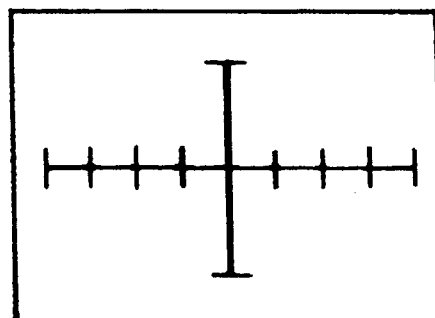

High, 100µF, 2000 Hz

Figure 11-10. Signatures of 100µF Capacitor in parallel with 1N4001 Diode Tested at 60 Hz and 2000 Hz.

### 11-6. RESISTOR AND CAPACITOR PARALLEL COMBINATION

As previously discussed, a capacitor produces an ellipse and a resistor produces a rotated straight line. Consequently, a resistor reduces the size of an ellipse and causes its major axis to rotate. The magnitude of the angle is determined by the value of the resistor and the range selected on the 2000.

Figure 11-11 shows the effect of a  $50\text{K}\Omega$  resistor on a  $.1\mu\text{F}$  capacitor (rotation and shrinkage of the ellipse) in the High range.

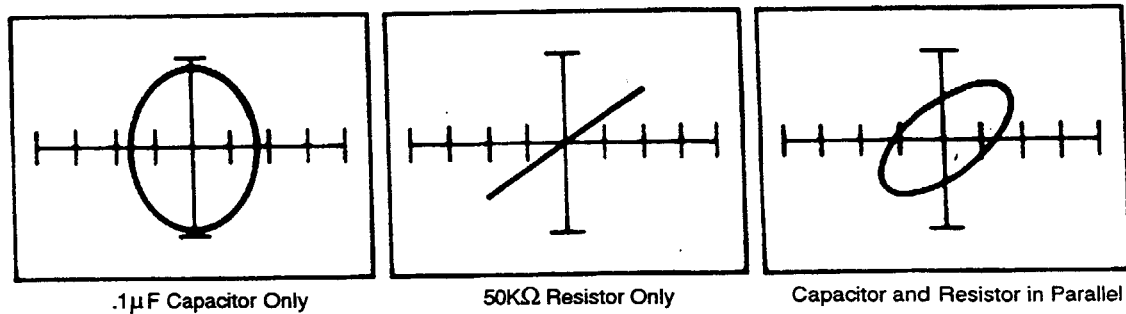

Figure 11-11. Effect of a  $50\text{K}\Omega$  Resistor on a  $.1\mu\text{F}$  Capacitor in the High Range at 60 Hz.

Figure 11-12 shows the effect of a  $1\text{K}\Omega$  resistor on a  $1\mu\text{F}$  capacitor in the Medium 1 range.

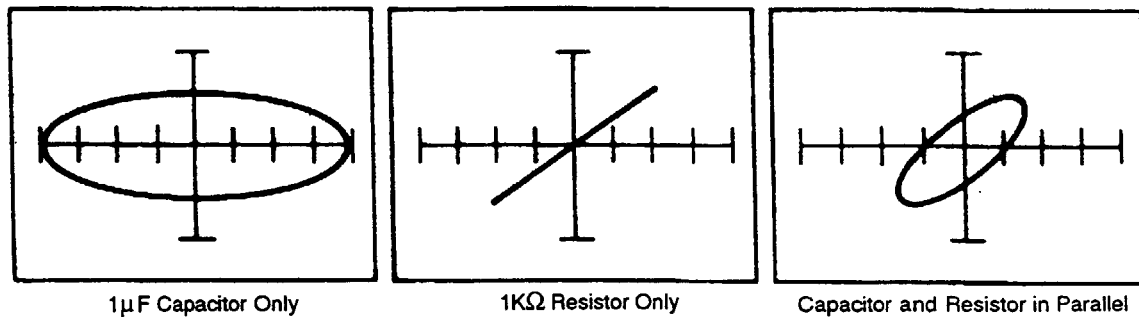

Figure 11-12. Effect of a  $1\text{K}\Omega$  Resistor on a  $1\mu\text{F}$  Capacitor in the Medium 1 Range at 60 Hz.

### 11-7. INDUCTOR AND DIODE PARALLEL COMBINATION

This type of circuit is found in relays and line printers. The diode suppresses the high voltage "kick" produced when the inductor or coil is de-energized.

Figure 11-13 displays signatures of a 1N4001 diode in parallel with an Aromat relay HB1E-DC12.

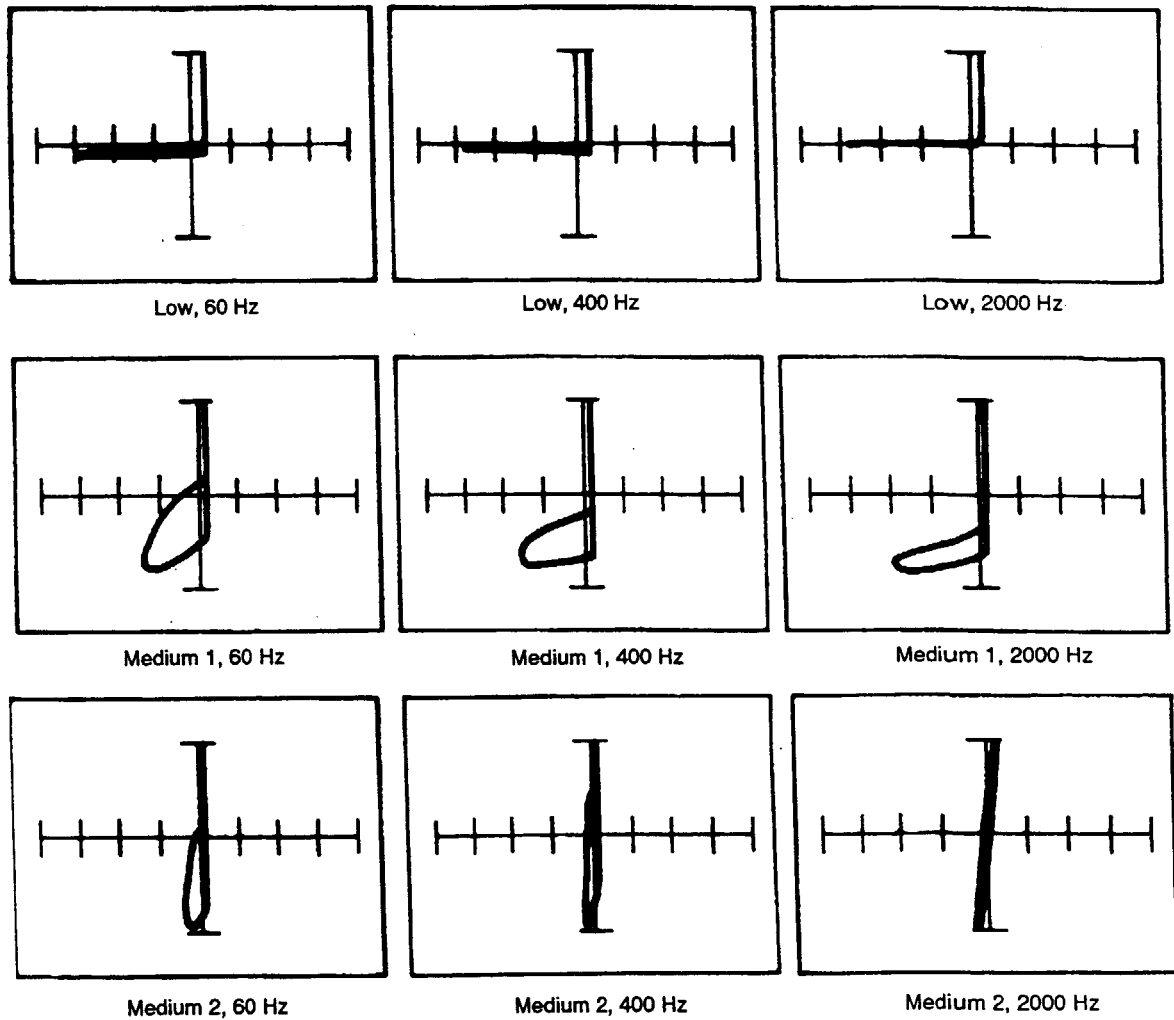

Figure 11-13. Signatures of a 1N4001 Diode in Parallel with an Aromat Relay HB1E-DC12.

**TESTING MULTIPLE COMPONENT CIRCUITS**

**NOTES:**

# SECTION 12

## TESTING INTEGRATED CIRCUITS

### 12-1. INTRODUCTION

### 12-2. Integrated Circuit Technology

An integrated circuit consists of a single crystal chip of silicon, typically 50 x 50 mils in cross-section, containing both active and passive elements, plus their interconnections. Such circuits are produced by the same processes used to fabricate individual transistors and diodes. These processes include epitaxial growth, masked impurity diffusion, oxide growth, and oxide etching, using photolithography for pattern definition.

The basic structure of an integrated circuit is shown in Figure 12-1, and consists of four distinct layers of material. The bottom layer (1) (6 mils thick) is P-type silicon and serves as a substrate upon which the integrated circuit is to be built. The second layer (2), typically 25 mils thick, is an N-type layer which is grown as a single crystal extension of the substrate. All components are built within the N-type layer using a series of diffusion steps. The third layer of material (3) is silicon dioxide, and it also provides protection of the semiconductor surface against contamination. Finally, a fourth metallic (aluminum) layer (4) is added to supply the necessary interconnections between components.

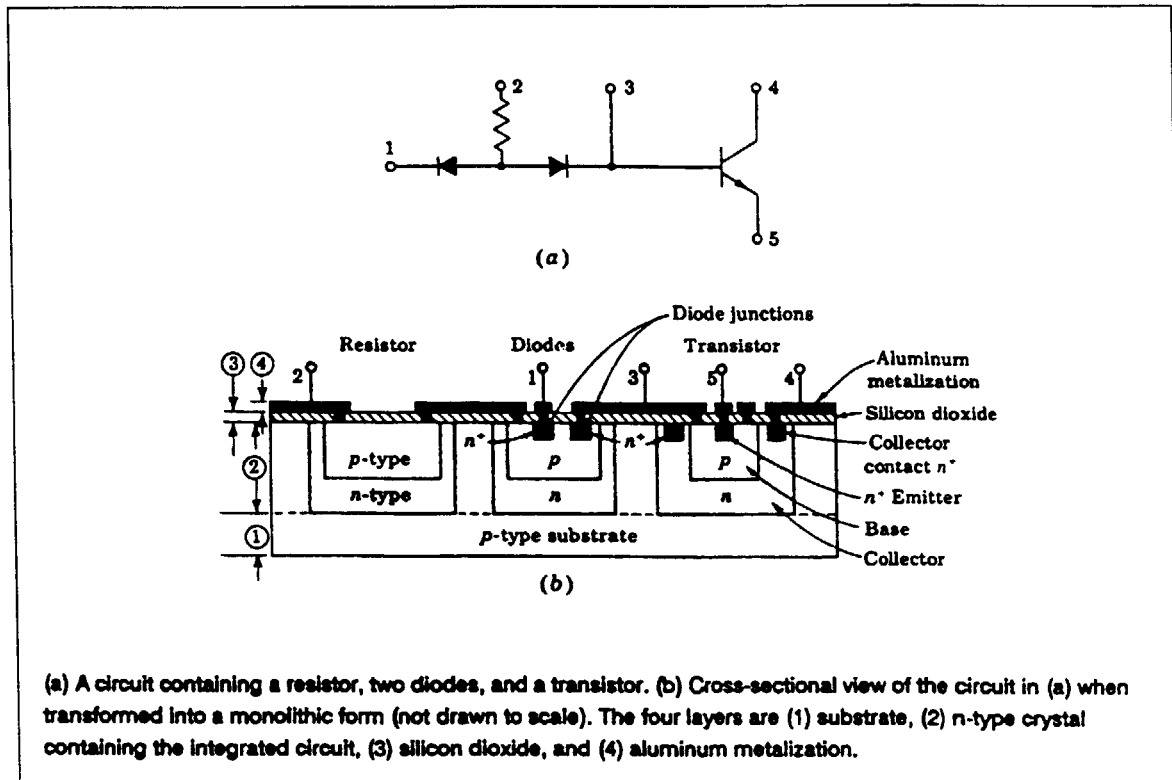

Figure 12-1. Typical Integrated Circuit Construction.

## 12-3. Integrated Circuit Testing Techniques

This manual has discussed the techniques of testing resistors, capacitors, inductors, diodes, and transistors. All these techniques can be applied to test integrated circuits. The signature produced across any two pins of an integrated circuit is the resultant effect of resistors, diodes, transistors, and capacitors. Apply the probes between two pins on an integrated circuit to display the resultant signature of these composite components.

This section provides information related to testing the following devices:

- Linear operational amplifiers
- Linear voltage regulators
- 555 timers
- TTL digital ICs
- Low power Schottky TTL digital ICs
- CMOS digital ICs
- MOS static RAMs
- EPROMs
- Bipolar PROMs
- Digital to Analog converters
- Microprocessors

To test an integrated circuit, the leads are connected to two pins at a time. Since the typical integrated circuit has many pins, the number of possible testing combinations becomes very large; for example, a 16 pin device has 120 possible two pin combinations. It becomes impractical to test all possibilities, and our experience has shown that it is adequate to test the input and output pins with respect to V+ or V- in order to determine whether a device is good or bad.

Since there are two ways to hook up the 2000 to any two pins of an integrated circuit, it is necessary to establish a polarity convention so that the user can reproduce all signatures properly on the CRT display. Throughout this section, the convention used is as follows:

- The first pin mentioned is connected to the channel A (or channel B) test terminal on the 2000.
- The second pin is the common pin which is connected to the COMMON test terminal on the 2000.

As an example, a figure that is titled "Signatures Between Pin 5 and Pin 8 of an XXXX at 60 Hz" means that the channel A probe should be connected to pin 5 of the IC and that the common probe should be connected to pin 8. Also, the phrase "...with respect to pin 8" means that pin 8 is the common pin.



### 12-4. LINEAR OPERATIONAL AMPLIFIERS

When checking an analog device or circuit, the low range is used most of the time. Analog circuits have many more single junctions to examine, and analog flaws are easier to detect in the low range. The 54Ω internal impedance of the low range makes it less likely that other components, in parallel with the device under test, will load the 2000 sufficiently to modify the signatures produced if the device were tested out of circuit.

When checking an op amp in-circuit, it is almost mandatory to do a direct comparison with a known-good circuit because the many different feedback loops associated with op amps may cause an almost infinite number of signatures. Figure 12-2 shows the schematic and connection diagram of a National Semiconductor 1458 Op Amp.

Figure 12-3 through 12-6 shows the signatures of various pins of the LM1458 with respect to pin 8 (V+), while Figures 12-7 through 12-9 show the signatures of the same pins with respect to pin 4 (V-). Figure 12-10 shows the signatures of a defective LM1458.

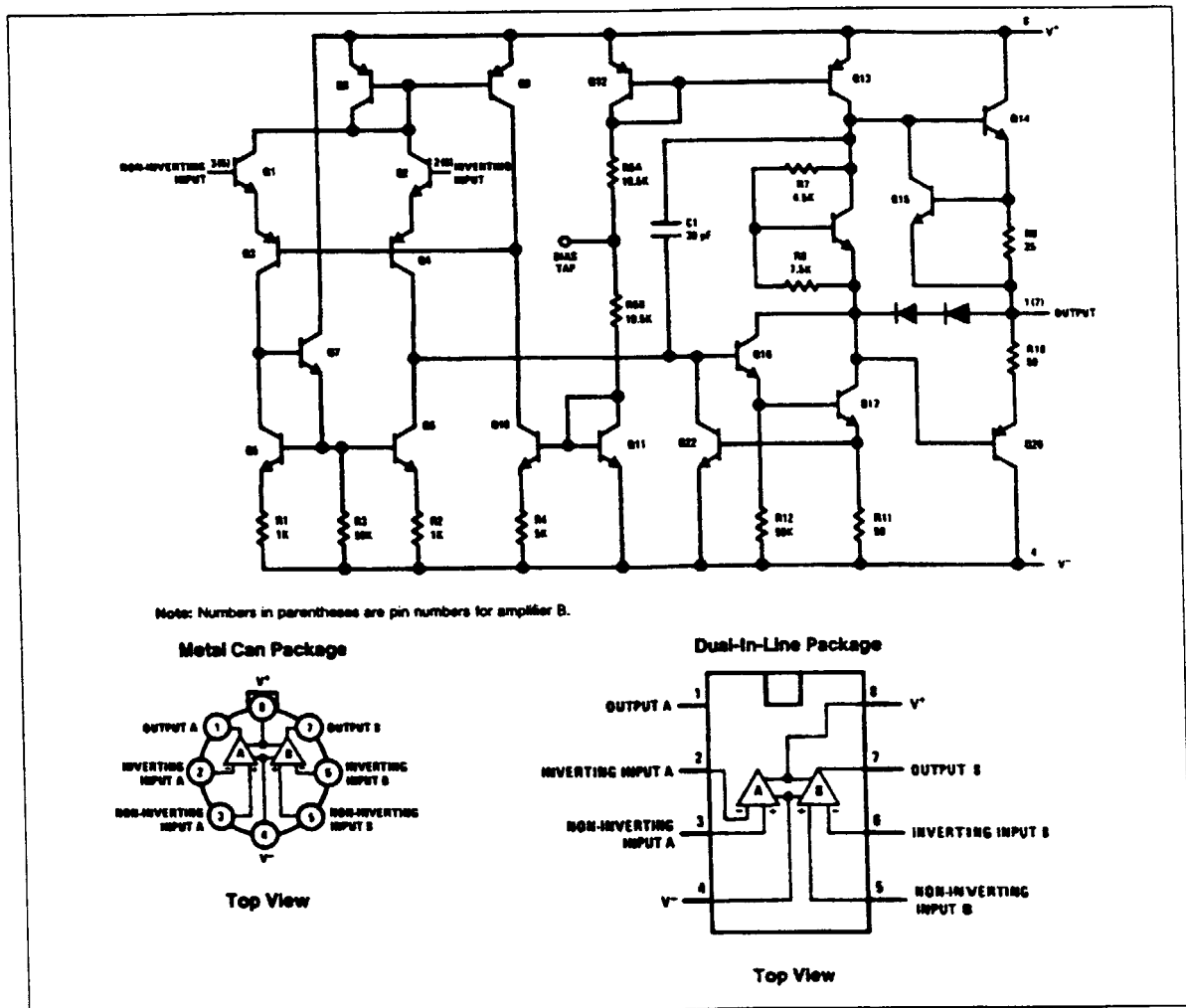

Figure 12-2. The LM1458 Op Amp, Schematic and Connections.

TESTING INTEGRATED CIRCUITS

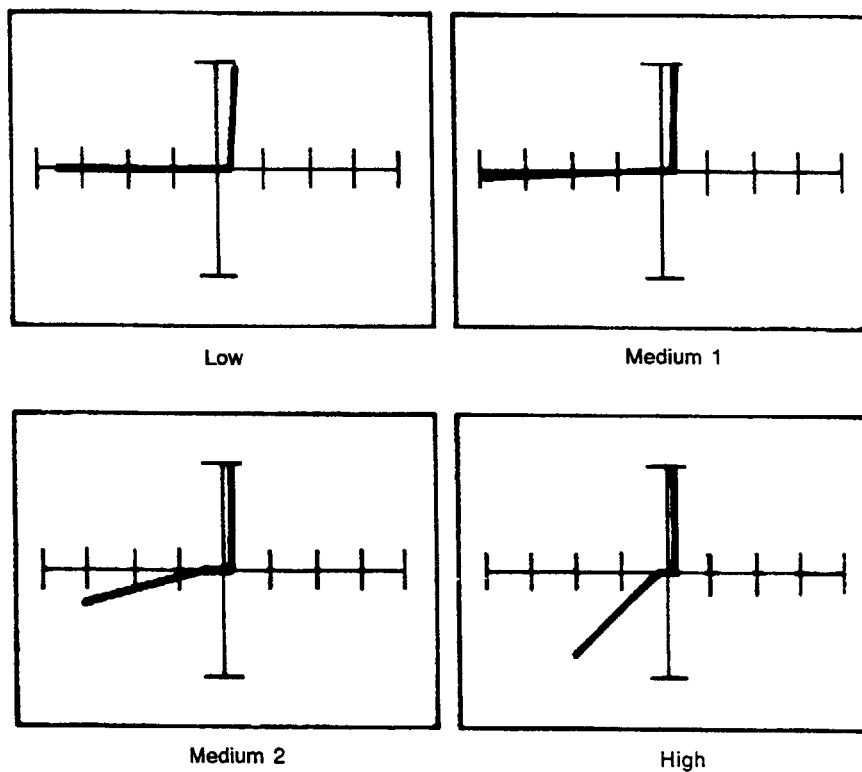

Figure 12-3. Signatures Between Pin 4 (V-) and Pin 8 (V+) of an LM1458 at 60 Hz.

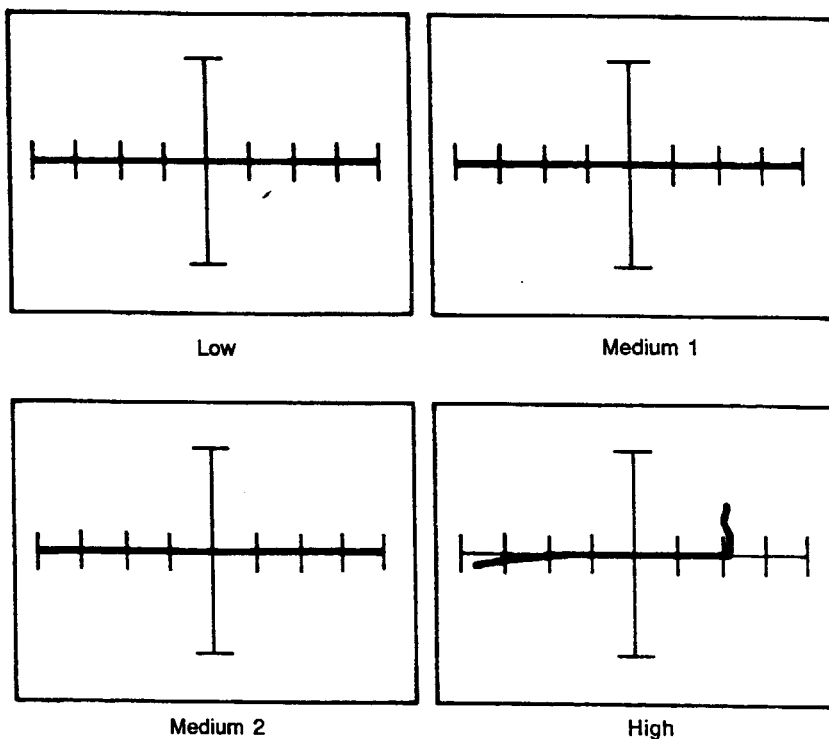

Figure 12-4. Signatures Between Pin 2 (Inverting Input) and Pin 8 (V+) of an LM1458 at 60 Hz.

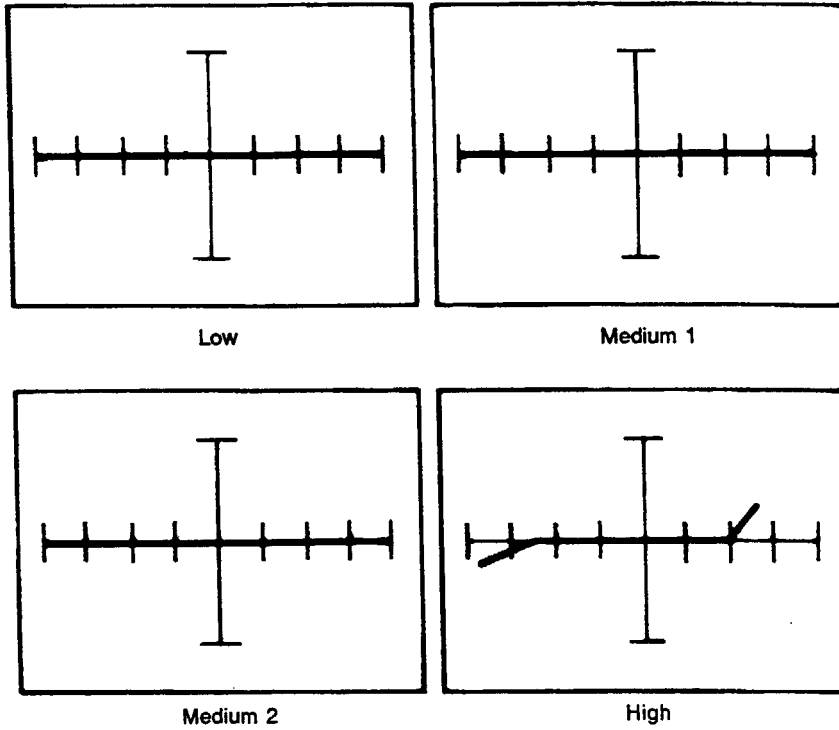

Figure 12-5. Signatures Between Pin 3 (Non-Inverting Input) and Pin 8 (V+) of an LM1458 at 60 Hz.

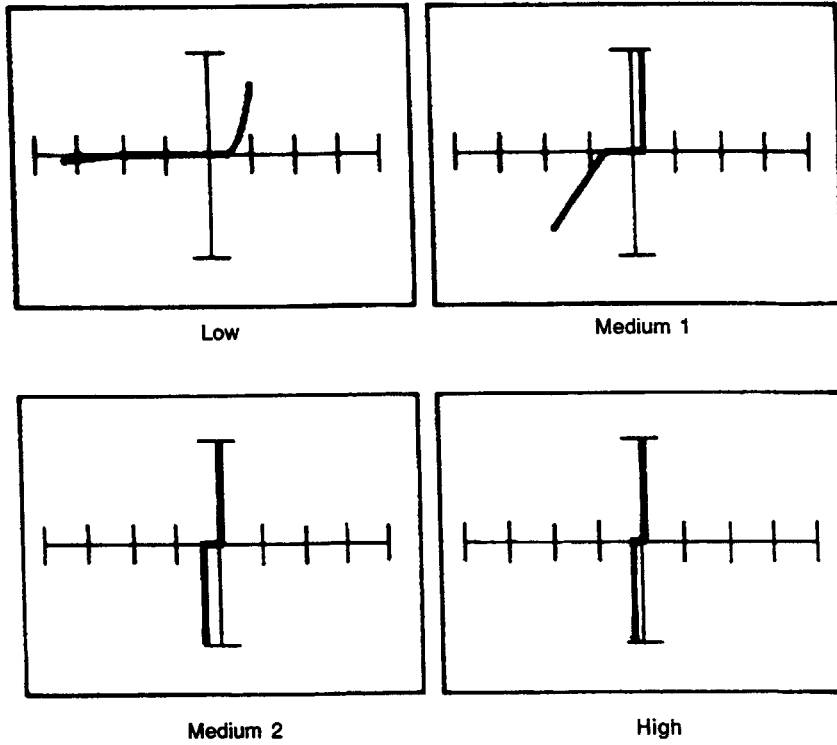

Figure 12-6. Signatures Between Pin 1 (Output) and Pin 8 (V+) of an LM1458 at 60 Hz.

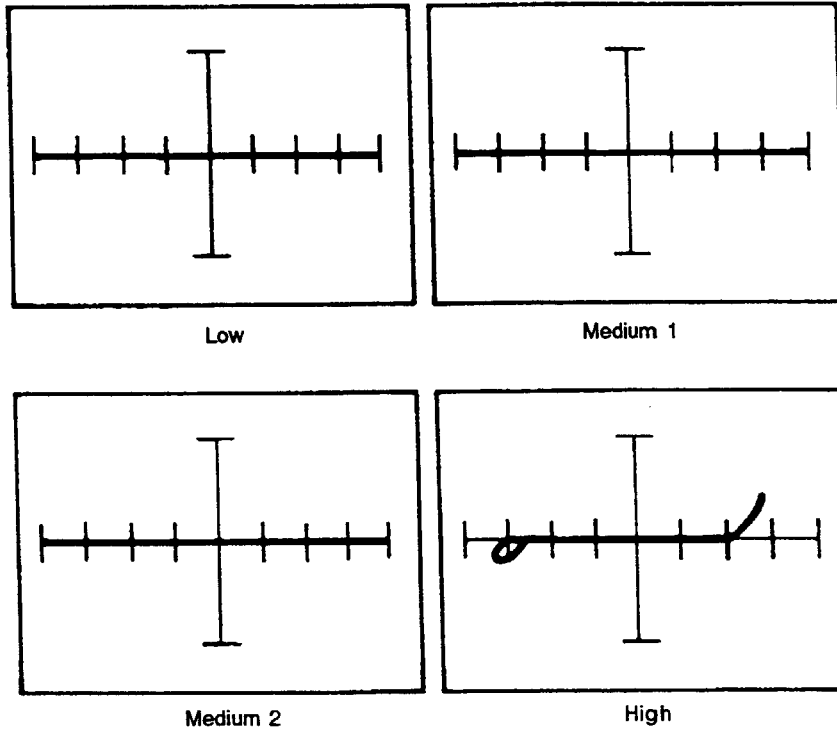

Figure 12-7. Signatures Between Pin 2 (Inverting Input) and Pin 4 (V-) of an LM1458 at 60 Hz.

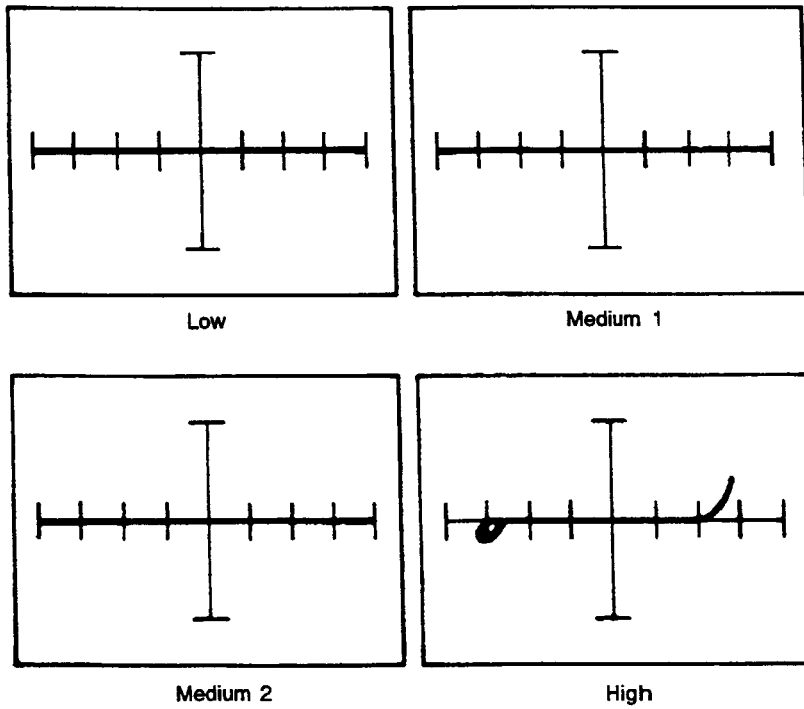

Figure 12-8. Signatures Between Pin 3 (Non-Inverting Input) and Pin 4 (V-) of an LM1458 at 60 Hz.

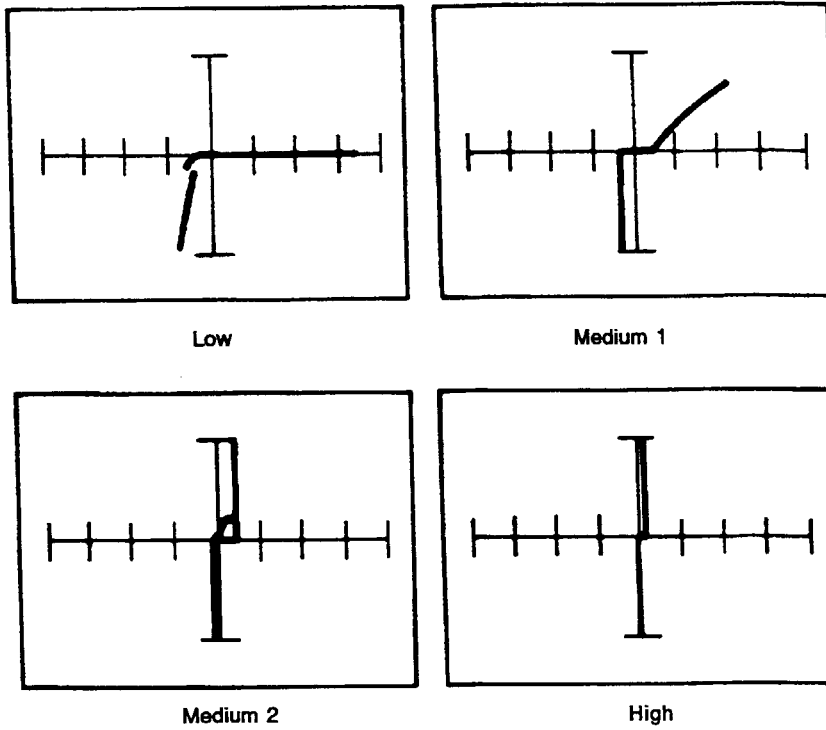

Figure 12-9. Signatures Between Pin 1 (Output) and Pin 4 (V-) of an LM1458 at 60 Hz.

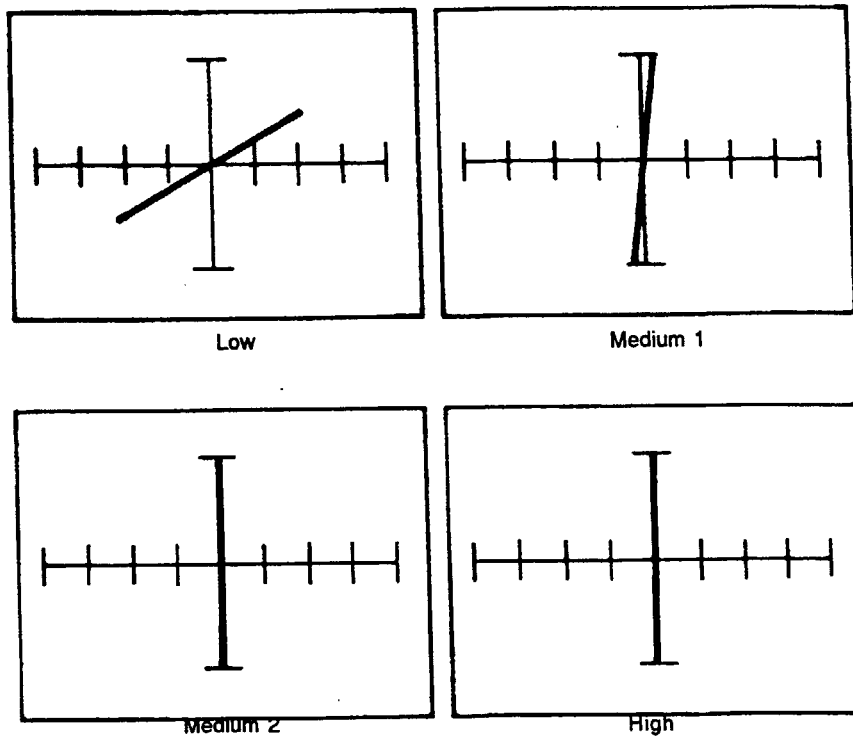

Figure 12-10. Signatures Between Pin 8 (V+) and Pin 4 (V-) of an LM1458 at 60 Hz.

## 12-5. LINEAR VOLTAGE REGULATORS

Voltage regulators, especially the 7800 and 7900 series, are used in many pieces of electronic equipment.

### 12-6. The 7805 Regulator

Figure 12-11 shows the schematic and pin layout of a 7805 + 5V regulator. Figures 12-12 through 12-14 show the test signatures for a 7805. Different manufacturers implement their products with different topologies and it is expected that the signatures will vary for the same devices from different manufacturers. Figure 12-14 shows the signatures of a defective 7805. There is a substantial difference in the signatures between a good device and a defective device in the low and medium 1 ranges.

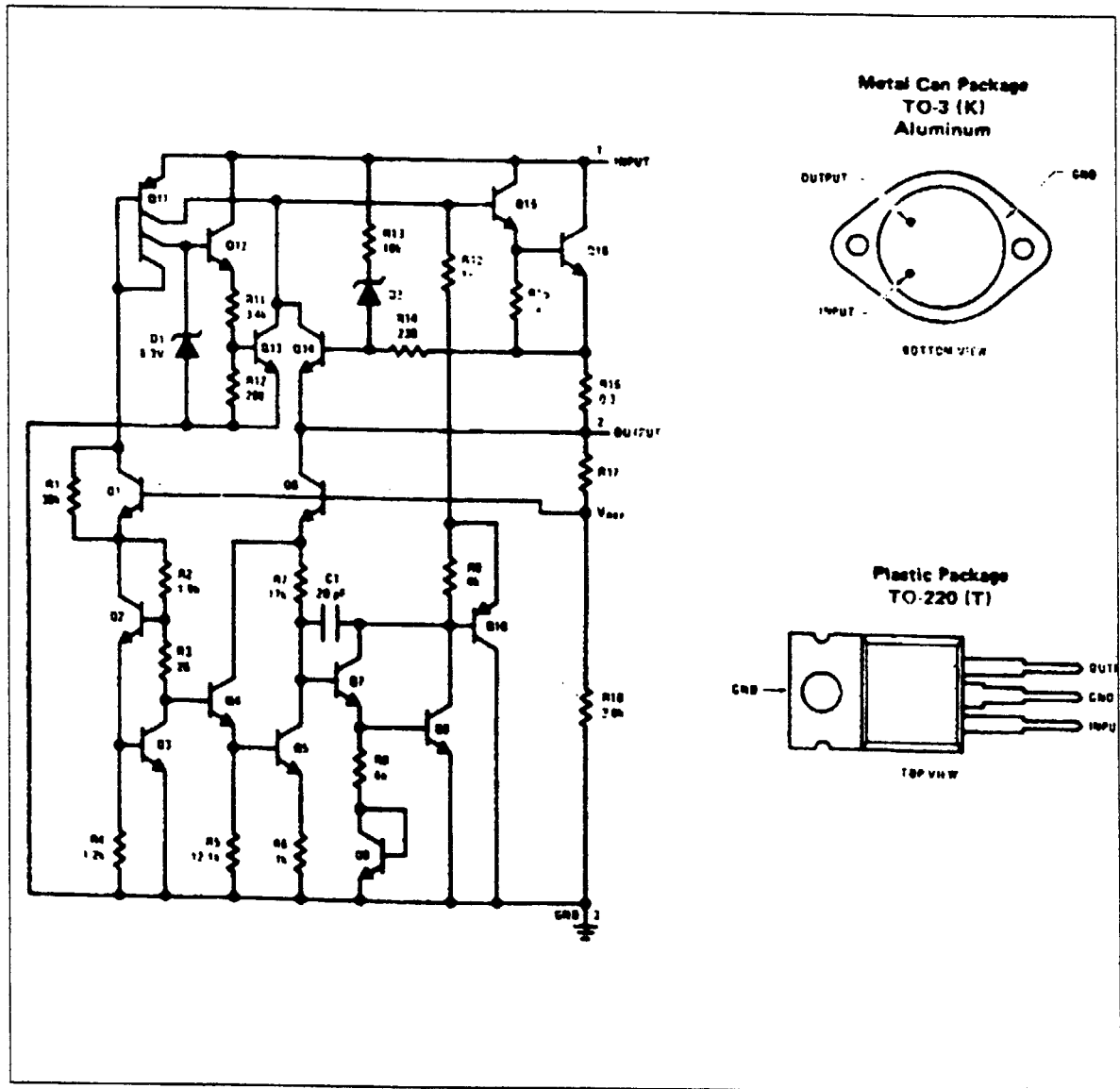

Figure 12-11. Schematic and Pin Layout of the 7805.

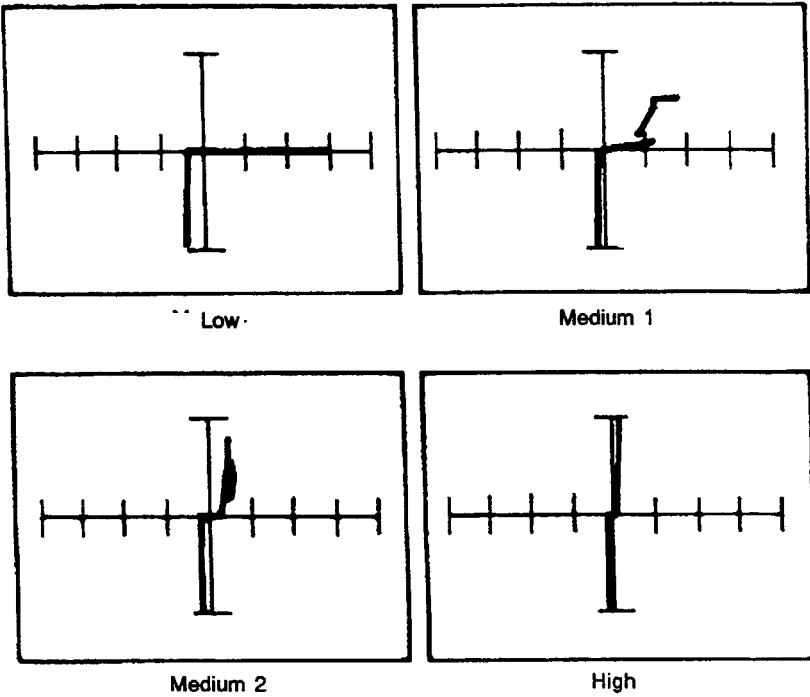

Figure 12-12. Signatures Between the Input and Ground Pins - 7805 at 60 Hz.

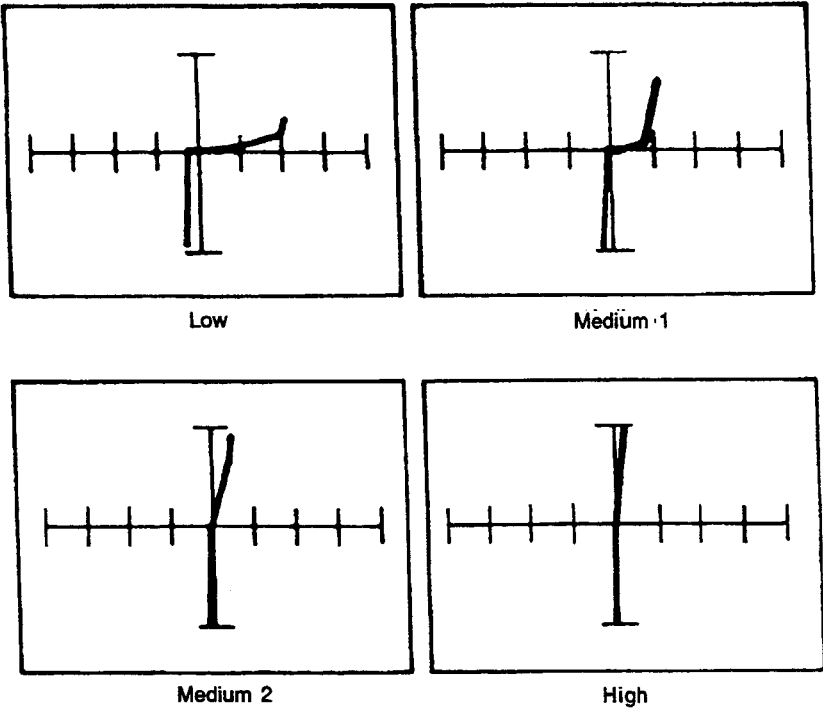

Figure 12-13. Signatures Between the Output and Ground Pins - 7805 at 60 Hz.

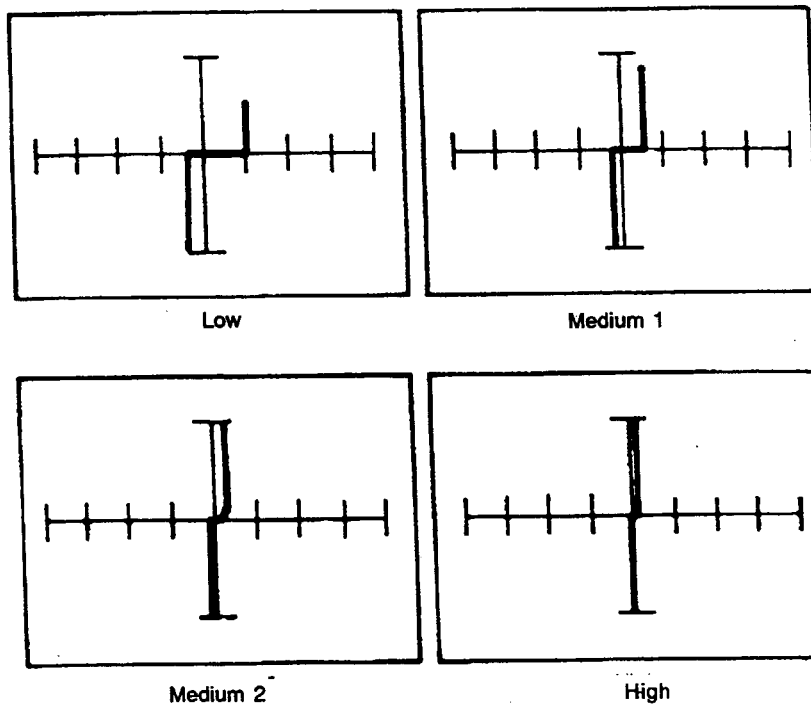

Figure 12-14. Signatures Between the Input and Output Pins - 7805 at 60 Hz.

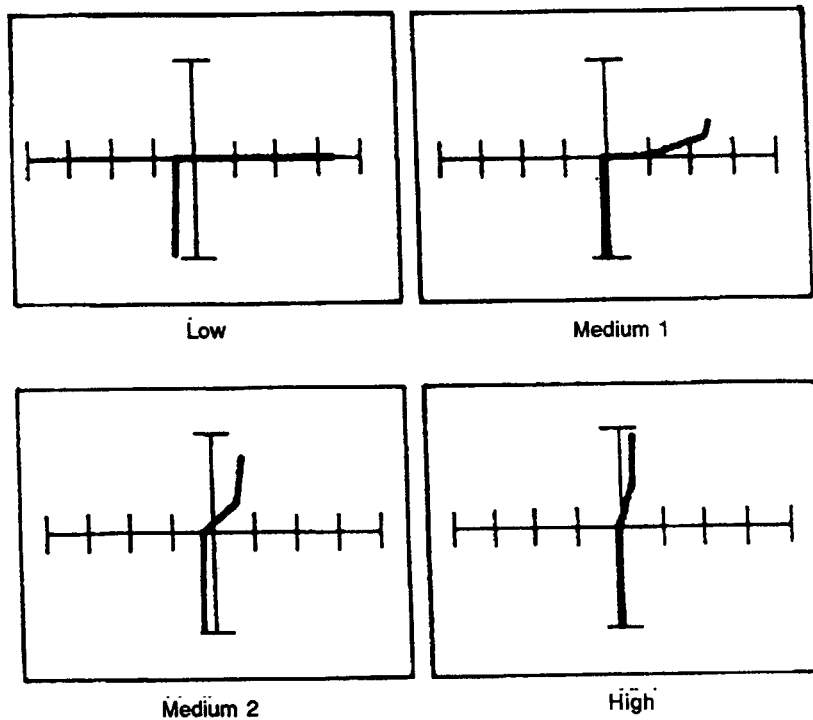

Figure 12-15. Signatures Between the Input and Output Pins of a Defective 7805 at 60 Hz.



### 12-7. The 7905 Regulator

Figure 12-16 shows the schematic and pin layout for a 7905 -5V regulator. Figures 12-17 through 12-19 show the test signatures for a 7905 voltage regulator on all ranges. Again, these signatures are for reference only and change slightly from manufacturer to manufacturer.

Figure 12-20 shows the signatures of a defective 7905 voltage regulator. Comparing Figure 12-19 and Figure 12-20 in medium 1 range, there is a significant difference in signatures.

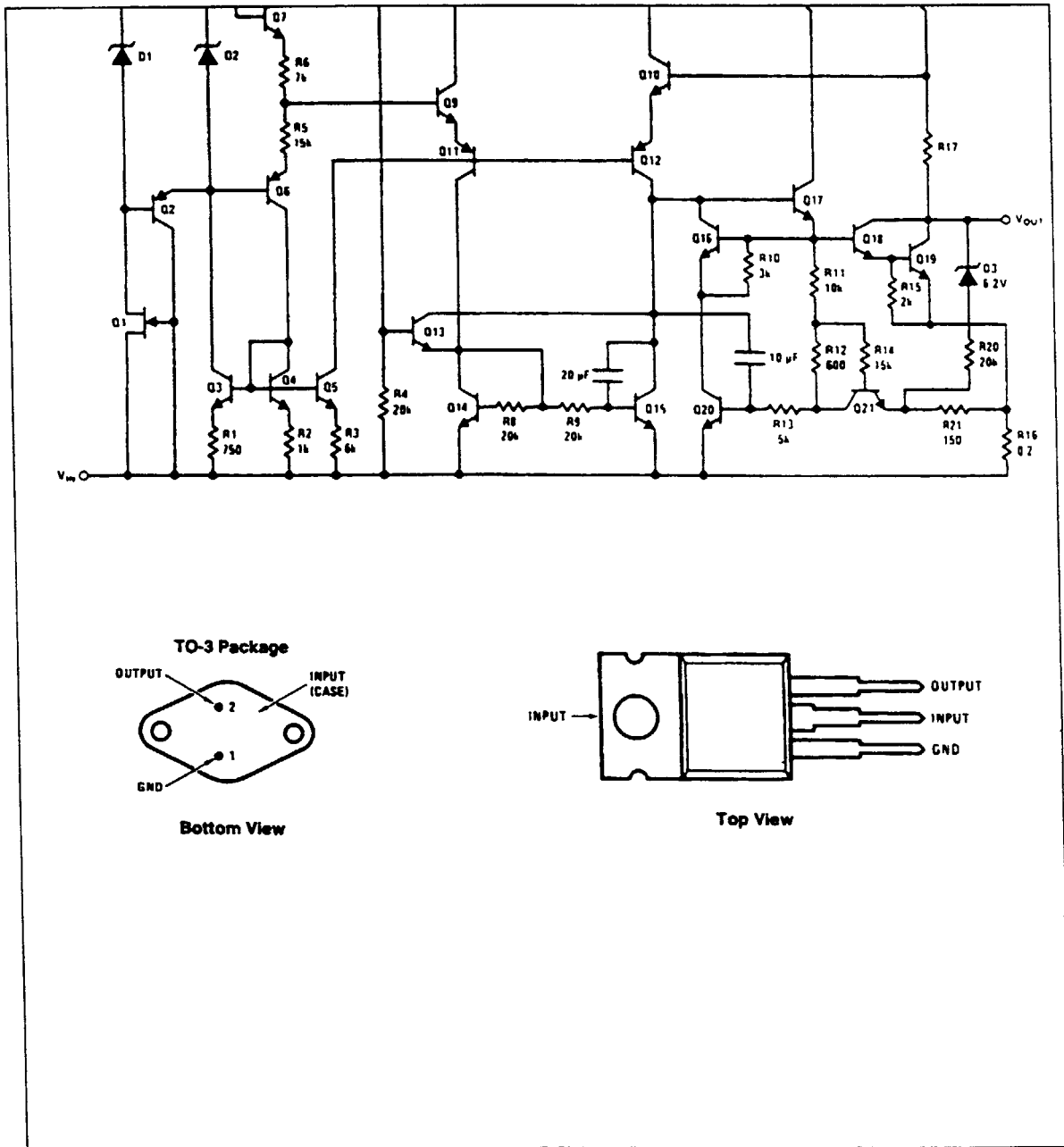

Figure 12-16. Schematic and Pin Layout of the 7905.

TESTING INTEGRATED CIRCUITS

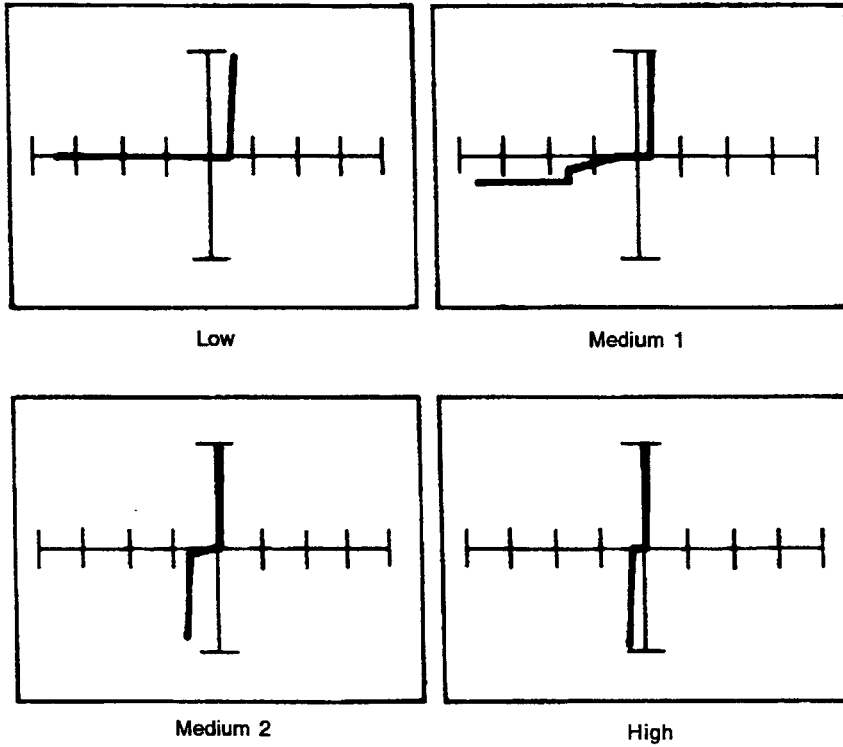

Figure 12-17. Signatures Between the Input and Ground Pins - 7905 at 60 Hz.

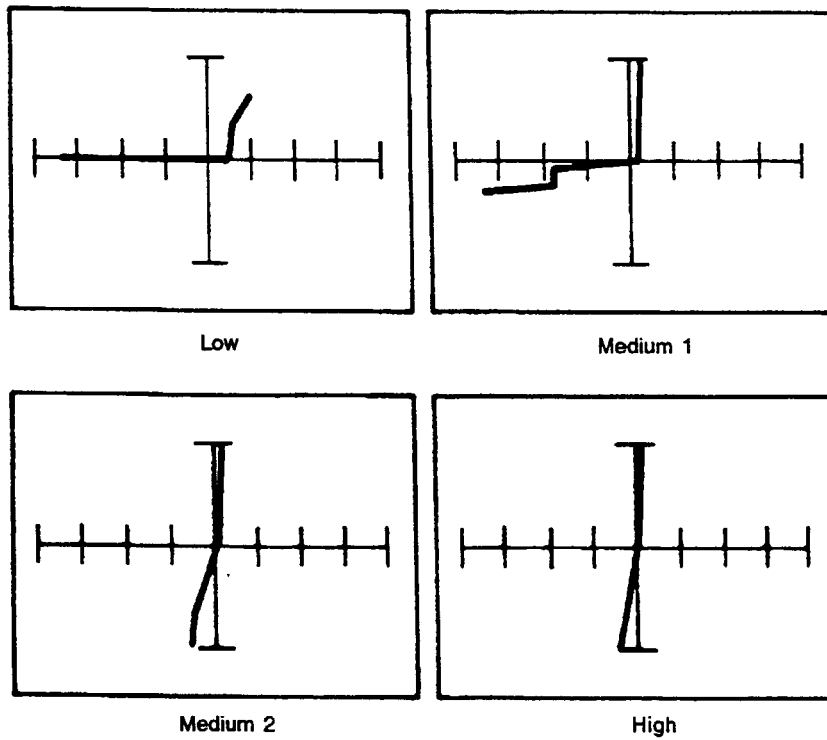

Figure 12-18. Signatures Between the Output and Ground Pins - 7905 at 60 Hz.

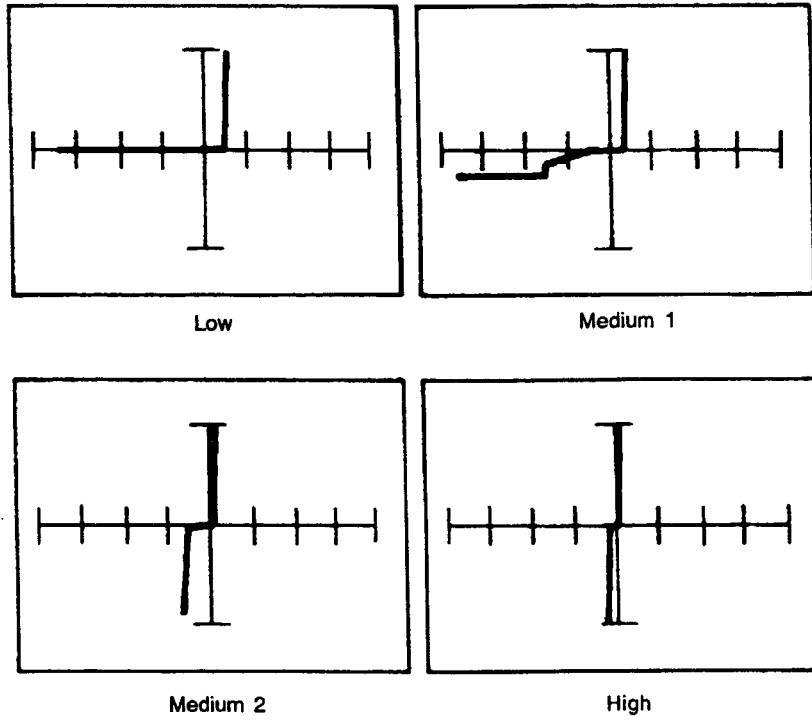

Figure 12-19. Signatures Between the Input and Output Pins - 7905 at 60 Hz.

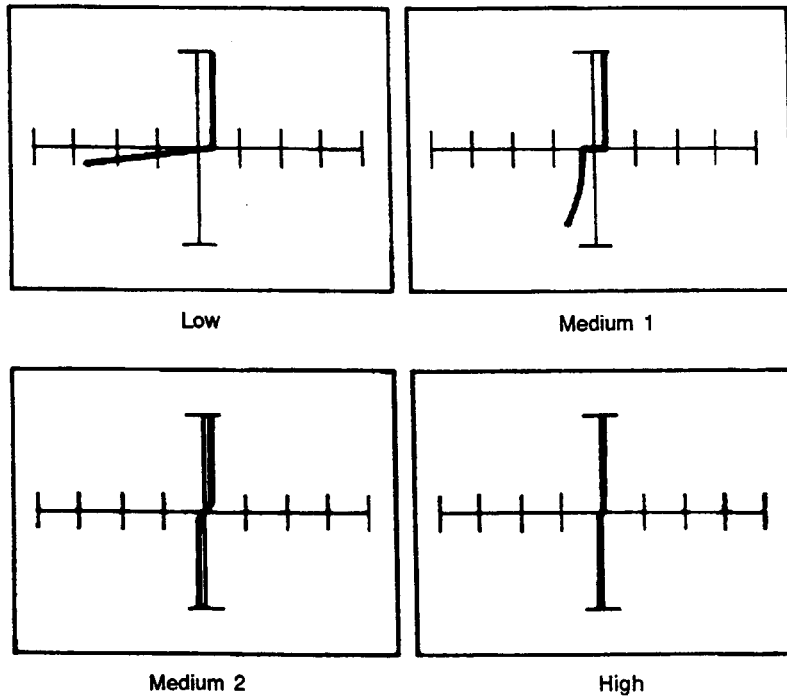

Figure 12-20. Signatures Between the Input and Output Pins of a Defective 7905 at 60 Hz.

## 12-8. 555 TIMERS

The 555 timer is a popular linear integrated circuit, and is used in precision timing, pulse generation, and pulse width modulation applications. The 2000 is used to examine signatures between various pins with respect to ground. Figure 12-21 shows the schematic and pin layout of the National Semiconductor LM555 timer.

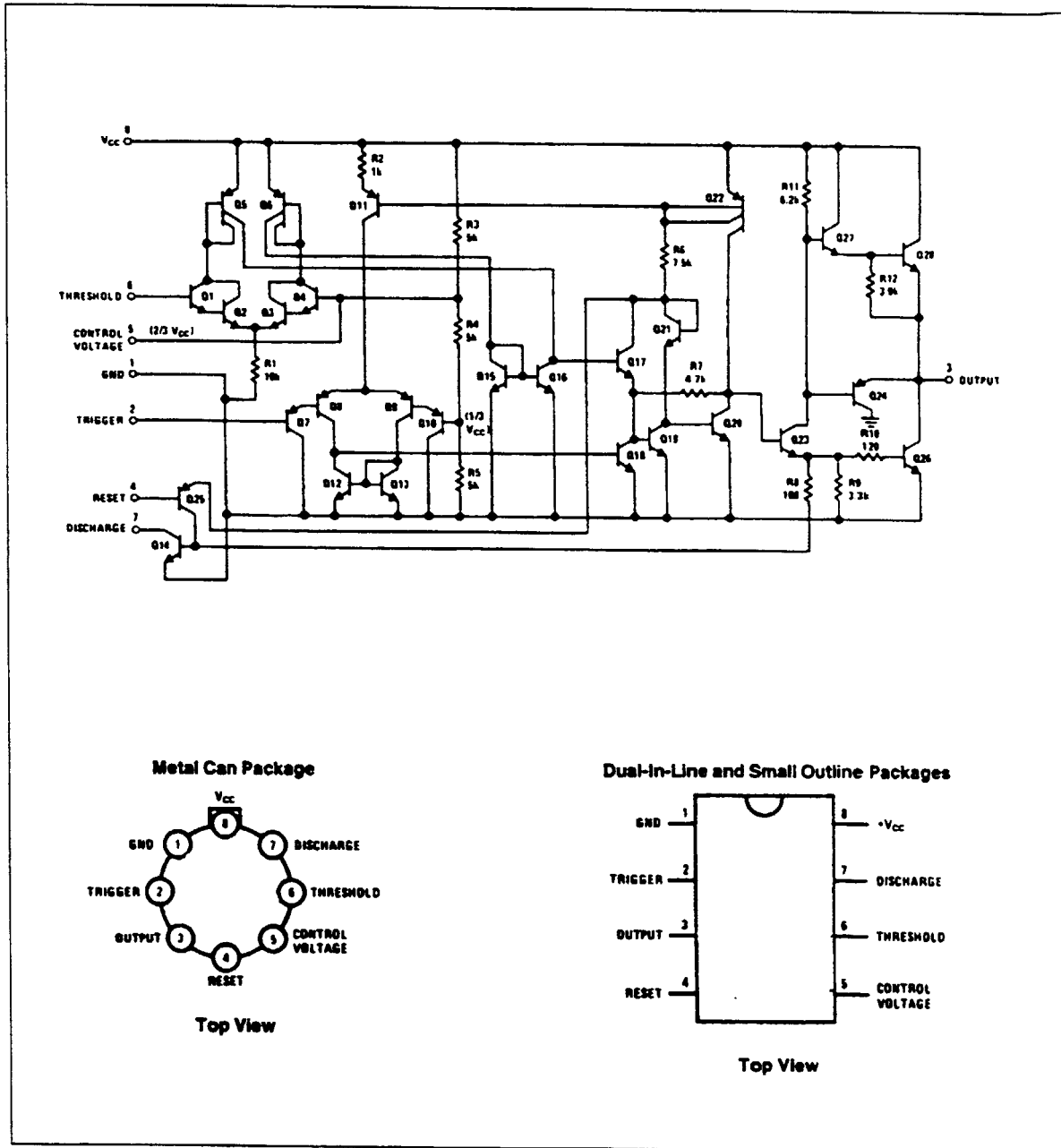

Figure 12-21. Schematic and Pin Layout of an LM555 Timer.

Figures 12-22 through 12-25, and 12-27 through 12-30, show the signatures between different pins of the LM555 using all ranges. In Figure 12-22 the 2000 displays the collector-base junction of transistor Q7 (see schematic in Figure 12-21).

Figure 12-24 shows the signatures between pin 4 (reset) and pin 1 (gnd). In this case, the 2000 displays the protection diode (not shown on the schematic).

Figure 12-25 shows the signatures between pin 5 (control voltage) and pin 1. Pin 5 is connected to resistors R3, R4, R5, and the Darlington transistor formed by Q3 and Q4. Refer also to Figure 12-26.

TESTING INTEGRATED CIRCUITS

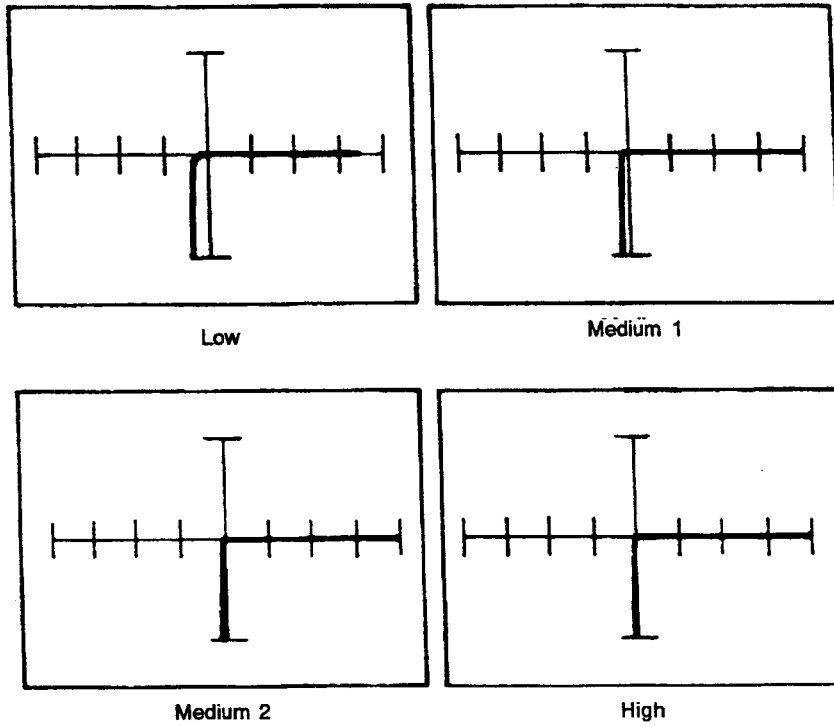

Figure 12-22. Signatures Between Pin 2 (Trigger) and Pin 1 of an LM555 Timer at 60 Hz.

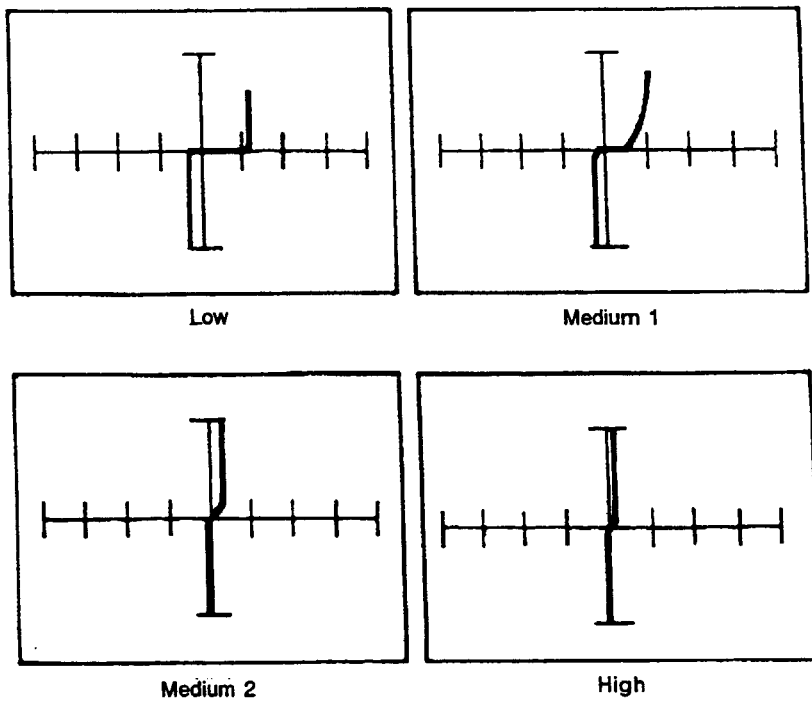

Figure 12-23. Signatures Between Pin 3 (Output) and Pin 1 of an LM555 Timer at 60 Hz.

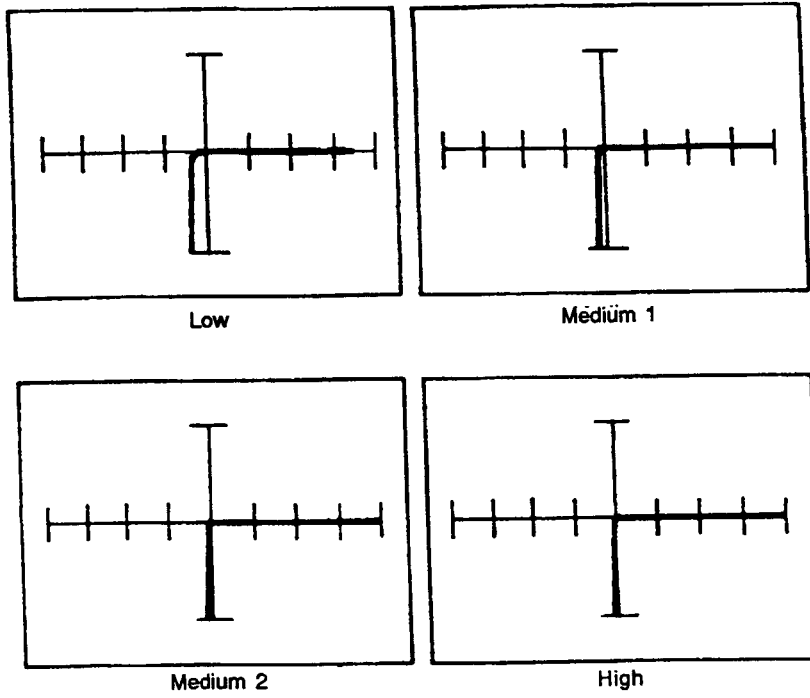

Figure 12-24. Signatures Between Pin 4 (Reset) and Pin 1 of an LM555 Timer at 60 Hz.

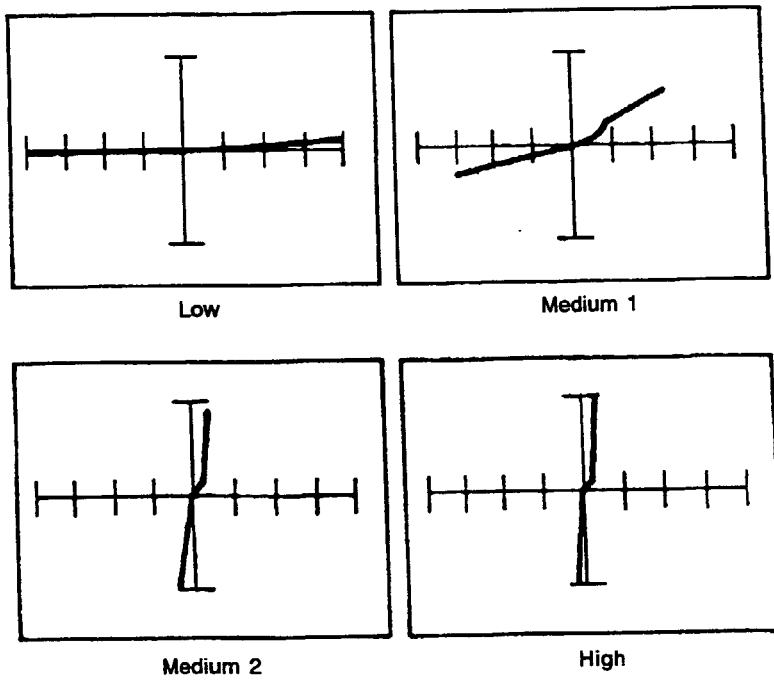

Figure 12-25. Signatures Between Pin 5 (Control Voltage) and Pin 1 of an LM555 Timer at 60 Hz.

## TESTING INTEGRATED CIRCUITS

Figure 12-27 shows the signatures between pin 6 and pin 1. Pin 6 is connected to a Darlington transistor (formed by Q1 and Q2) which is in series with resistor R1 (10K $\Omega$  resistor). The impedance is too high to show much change in the low range.

Figure 12-28 shows the signatures between pin 7 and pin 1. These pins are connected to the collector and emitter of Q14, however the dominant effect is caused by the protection diode that exists between these two pins.

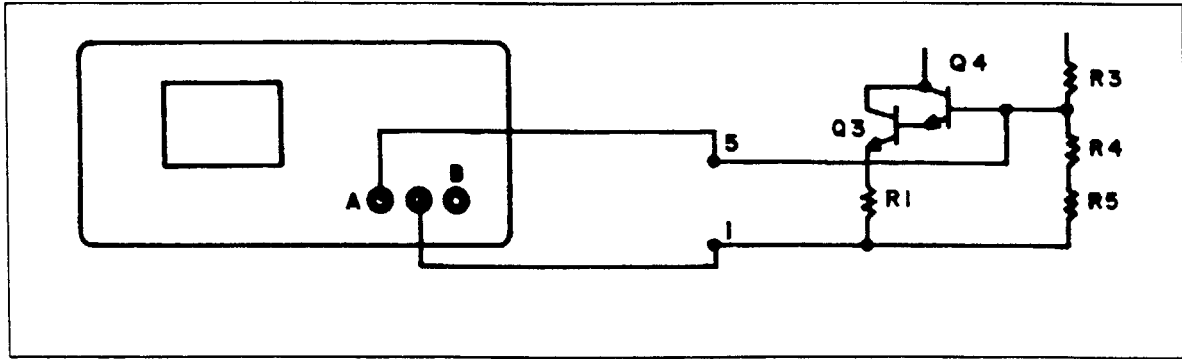

Figure 12-26. Test Circuit of an LM555 Timer Pin 5 and Pin 1.

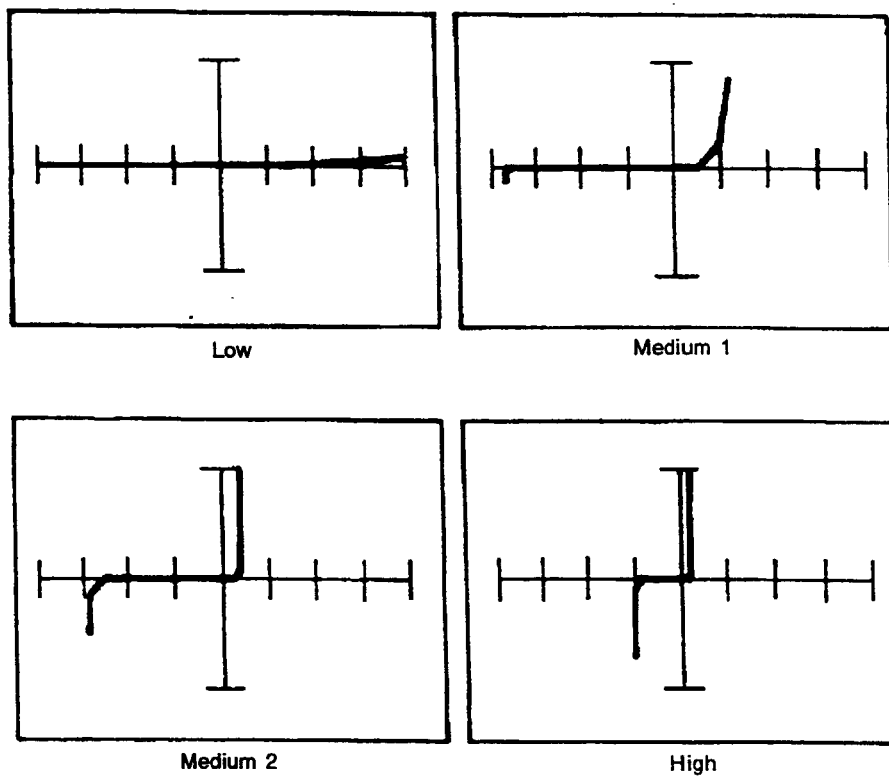

Figure 12-27. Signatures Between Pin 6 (Threshold) and Pin 1 of an LM555 Timer at 60 Hz.



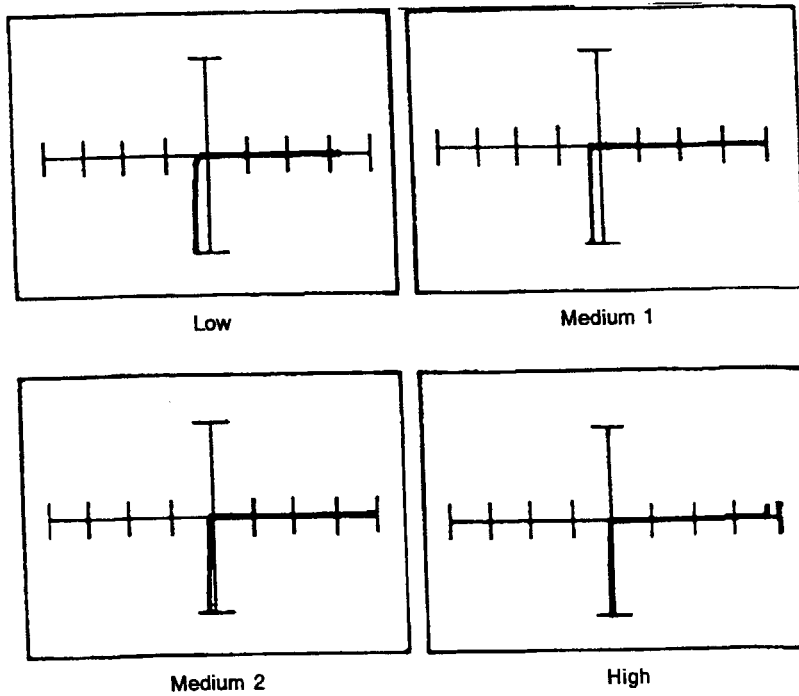

Figure 12-28. Signatures Between Pin 7 (Discharge) and Pin 1 of an LM555 Timer at 60 Hz.

Figure 12-29 shows the signatures between pin 8 ( $V_{cc}$ ) and pin 1. Figure 12-30 shows the signatures between the same pins of an LM555 timer which was damaged by power supply polarity reversal.

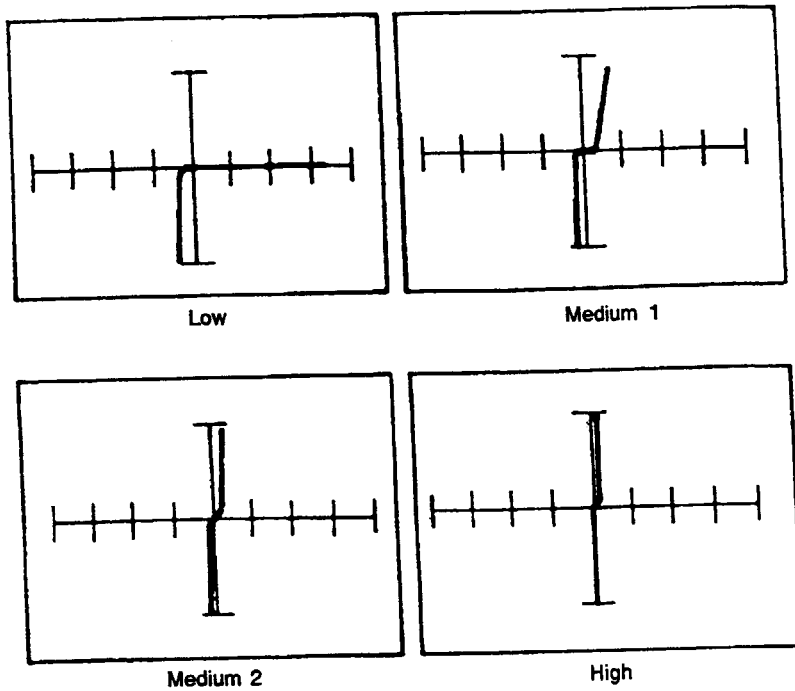

Figure 12-29. Signatures Between Pin 8 ( $V_{cc}$ ) and Pin 1 of an LM555 Timer at 60 Hz.

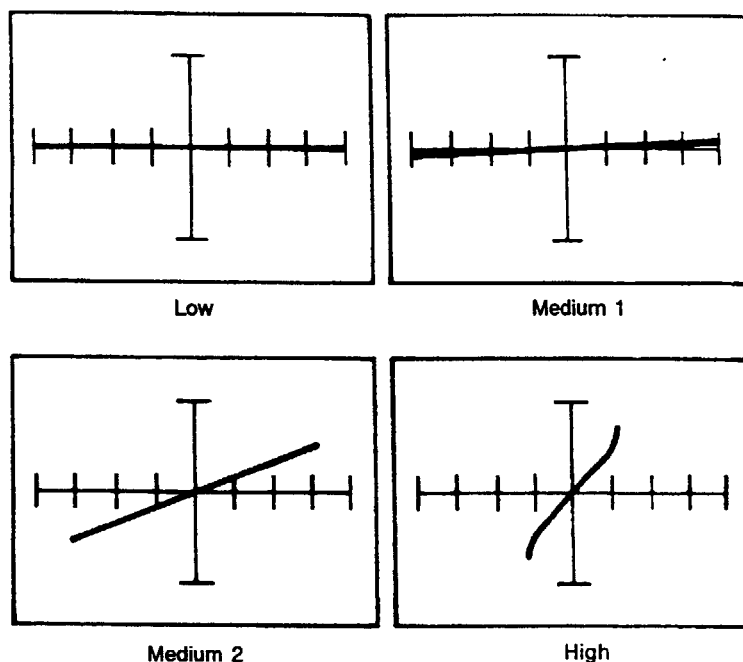

Figure 12-30. Signatures Between Pin 8 ( $V_{cc}$ ) and Pin 1 of a Damaged LM555 Timer at 60 Hz.

## 12-9. TTL DIGITAL INTEGRATED CIRCUITS

### 12-10. General

The schematics of the basic gates of the various families are shown in Figures 12-31a, b, c, d, and e. All are similar, containing inputs, gate, phase splitter (Q2 with emitter and collector load resistors), pull-up mechanism (Q3/Q4) and pull-down transistor (Q5). In all TTL circuits, except LS TTL circuits, the AND function is formed by a multiple-emitter transistor in which the emitter-base junctions serve to isolate the input signal sources from each other.

The inputs of these gates contain input protection diodes. To test a digital IC, we need to examine:

- Inputs with respect to ground to see if the input diode and transistor are damaged.
- Output pin with respect to ground to see if the C-E junction of Q5 is damaged.
- Output pin with respect to  $V_{cc}$  to see if Q4 is damaged.
- $V_{cc}$  with respect to ground. Generally, the 2000 can display flaws caused by overloading.

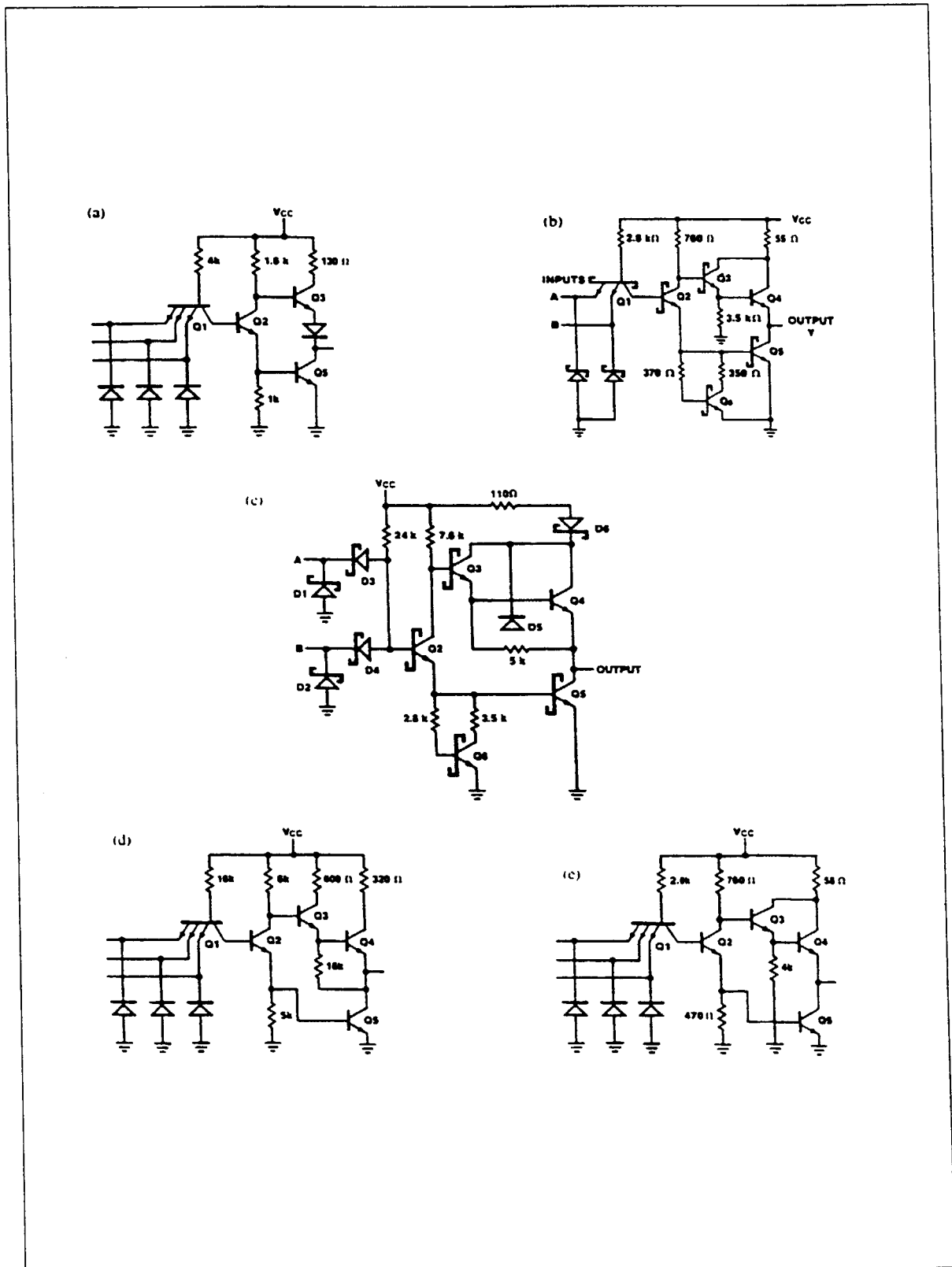

Figure 12-31. Various TTL Implementations.

### 12-11. TTL Devices With Totem Pole Output

Figures 12-32 through 12-34 show the signatures of input, output, and  $V_{cc}$  with respect to ground of the 7410 TTL device. As mentioned previously, the test signatures may vary from device to device, and from manufacturer to manufacturer, depending on the level of doping and logic implementation.

Figure 12-32 shows the signatures between an input pin and the ground pin. In the low range, the input protection diode signature is represented by XYZ instead of WYZ (as a regular diode would have been represented). The difference between a regular diode and a protection diode is that protection diodes have a  $50\Omega$  resistance in series with the diode junction.

Figure 12-33 shows the signatures between an output pin and the ground pin. In the low range, the test voltage is not high enough to cause non-destructive breakdown.

Figure 12-34 shows the signatures between the  $V_{cc}$  pin and the ground pin.

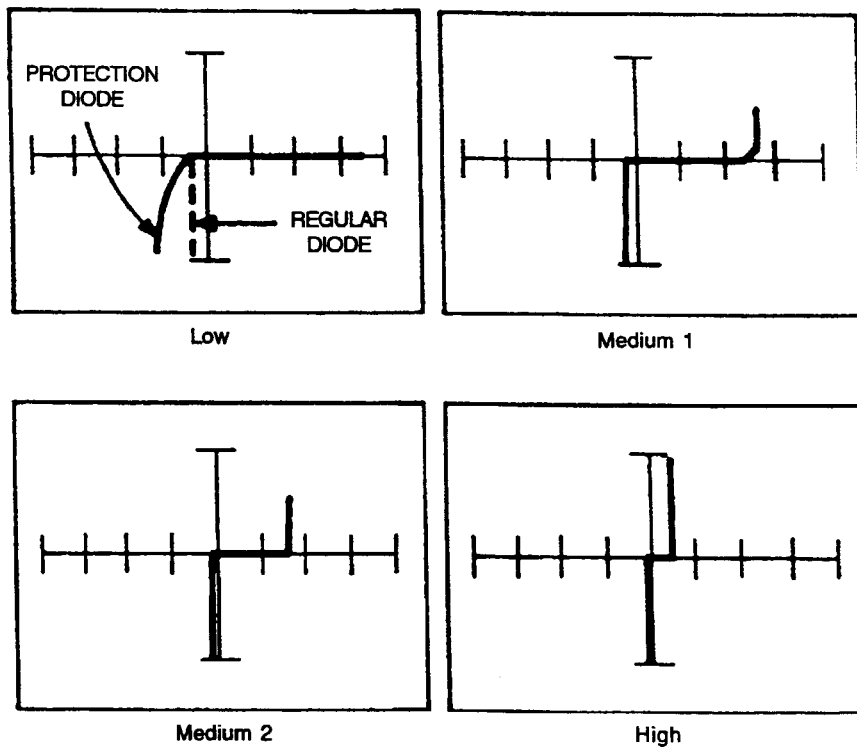

Figure 12-32. Signatures Between an Input Pin and the Ground Pin of a 7410 at 60 Hz.

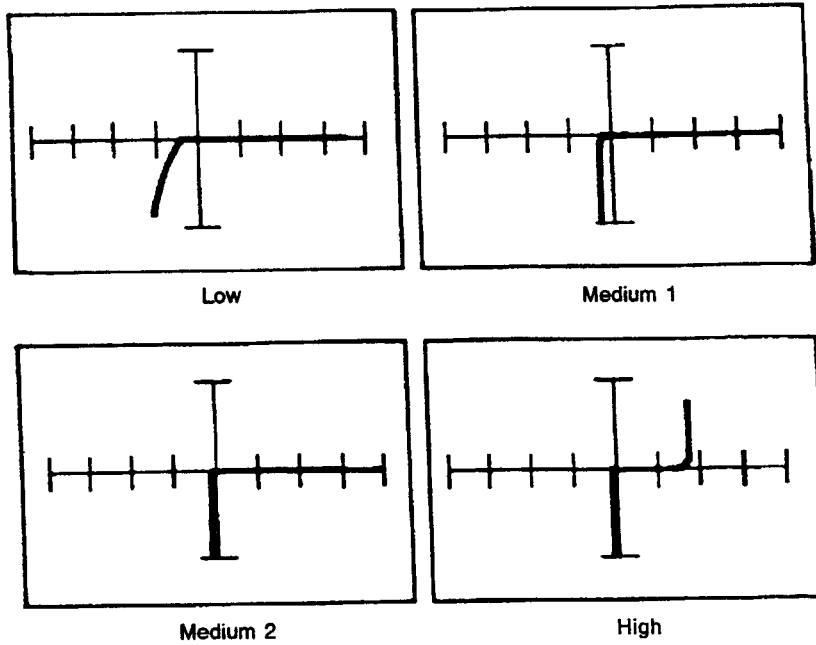

Figure 12-33. Signatures Between an Output Pin and the Ground Pin of a 7410 at 60 Hz.

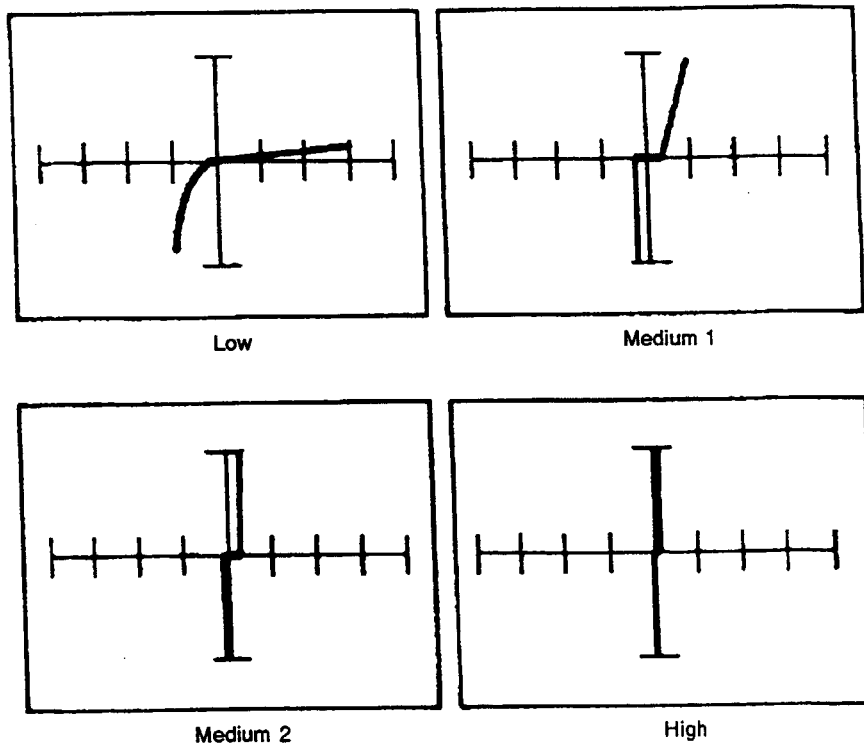

Figure 12-34. Signatures Between the  $V_{CC}$  Pin and the Ground Pin of a 7410 at 60 Hz.

## 12-12. LS TTL Devices

Implementation of LS digital ICs is different from others. The LS series is not implemented with multiple-emitter transistor topology. Figures 12-35 through 12-37 show the signatures between different pins of a 74LS32.

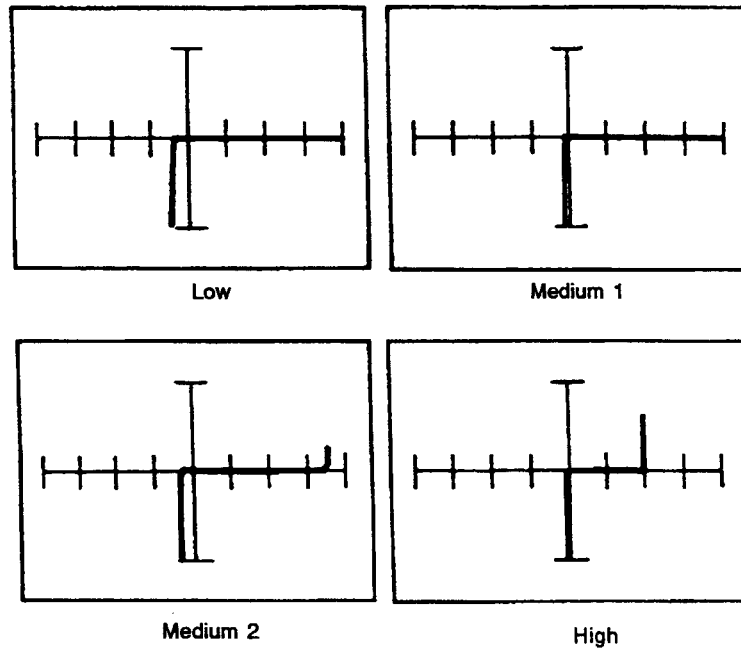

Figure 12-35. Signatures Between an Input Pin and the Ground Pin of a 74LS32 at 60 Hz.

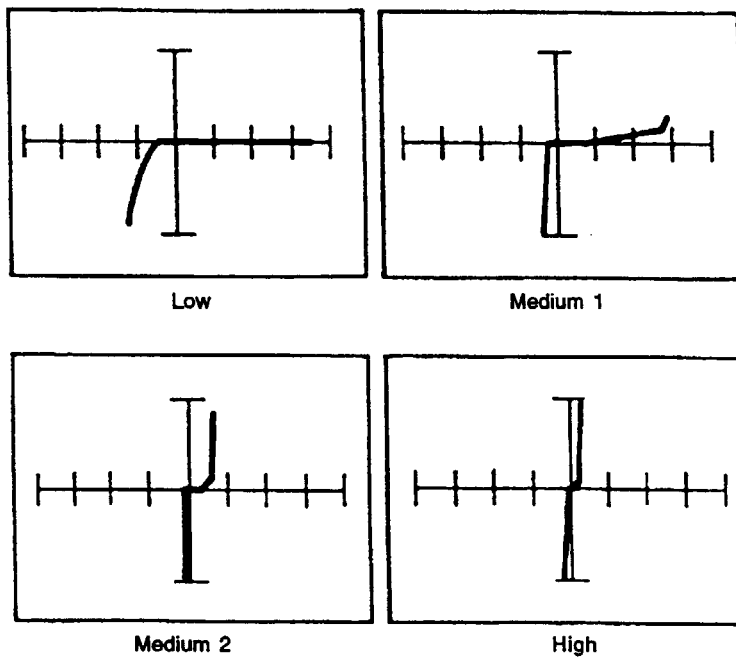

Figure 12-36. Signatures Between an Input Pin and an Output Pin of a 74LS32 at 60 Hz.

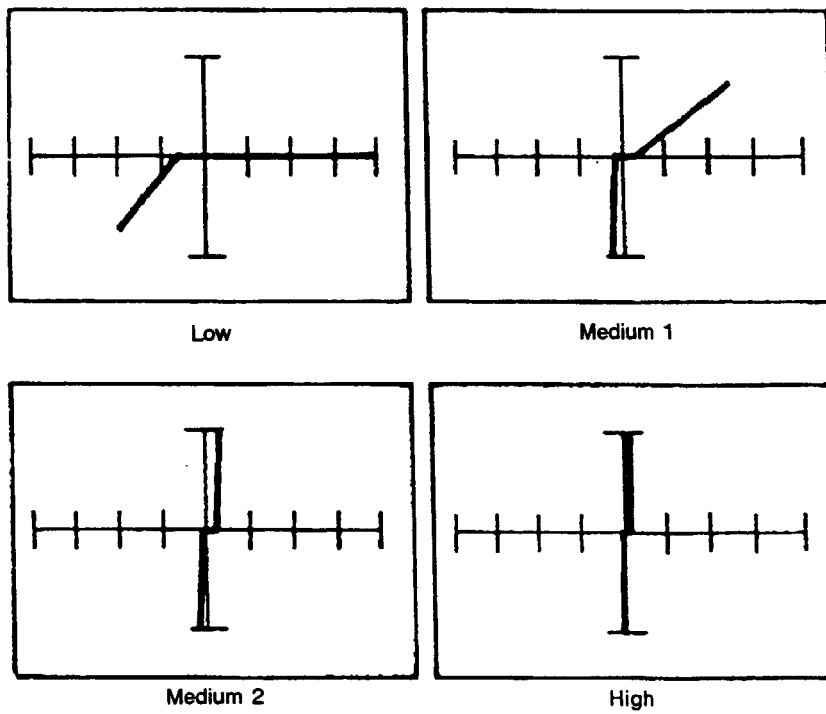

Figure 12-37. Signatures Between the Vcc Pin and the Ground Pin of a 74LS32 at 60 Hz.

### 12-13. Tri-State LS TTL Devices

In the tri-state LS TTL family, there are many circuits that have an auxiliary control input that allows both the output pull-up and pull-down circuitry to be disabled. This condition is called the high impedance (high Z) state and allows the outputs of different circuits to be connected to a common line or data bus. Figure 12-38 shows a typical tri-state output device. The device to be tested has power off so the enable pin is considered just another input pin, and tri-state devices are tested in the same manner as other TTL devices except their signatures are different. It is extremely easy to test a tri-state device when compared with a known-good device. Figure 12-39 shows a pin layout of a 74LS125.

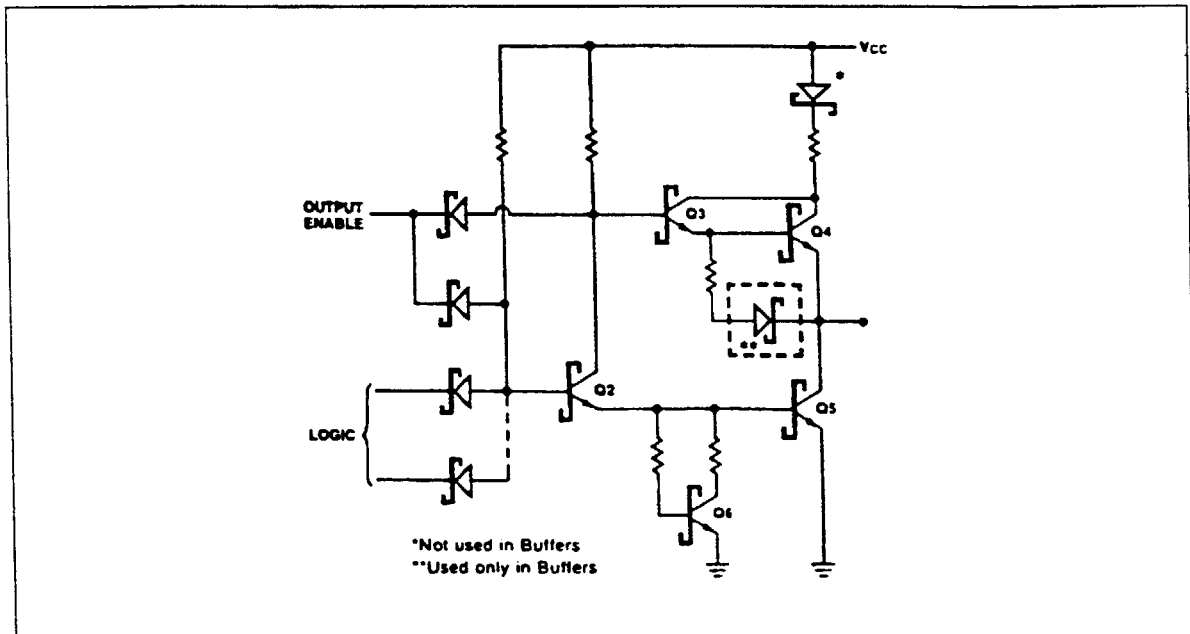

Figure 12-38. Typical Tri-State Output Control.

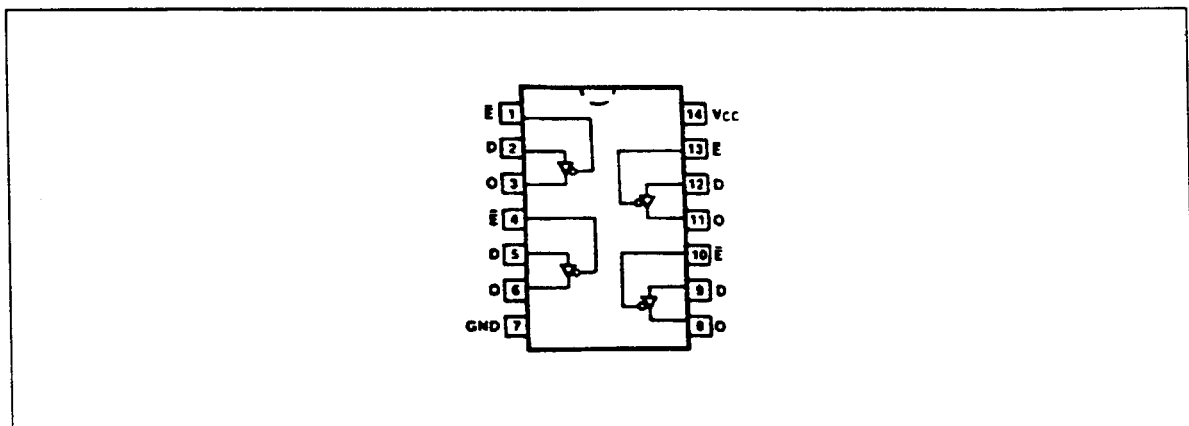

Figure 12-39. Pin Layout of a 74LS125.

Figure 12-40 shows the signatures between an input pin and ground pin, and Figure 12-41 shows the signatures between the enable pin and ground pin. These two figures exhibit similar signatures because both the input and enable pins have similar electrical paths to ground.



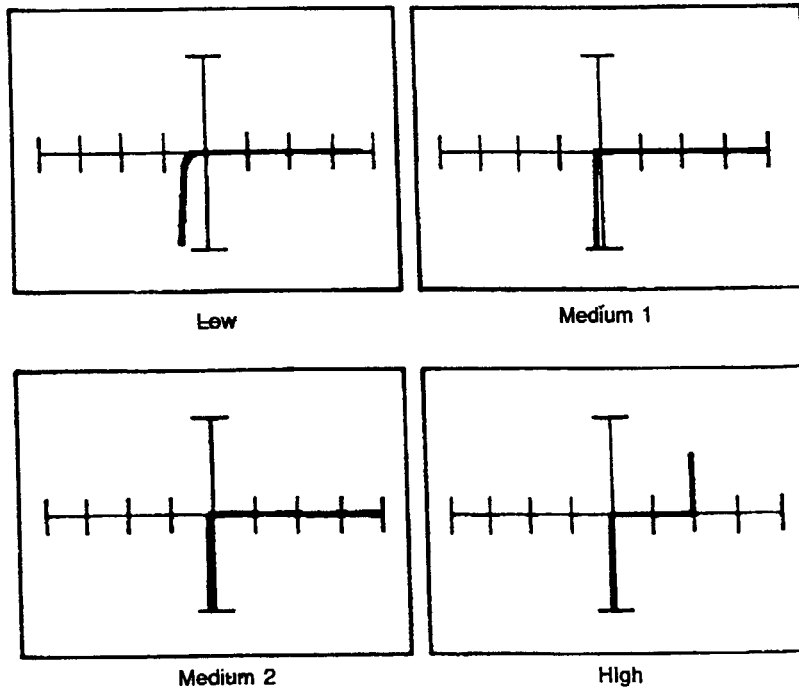

Figure 12-40. Signatures Between an Input Pin and the Ground Pin of a 74LS125 at 60 Hz.

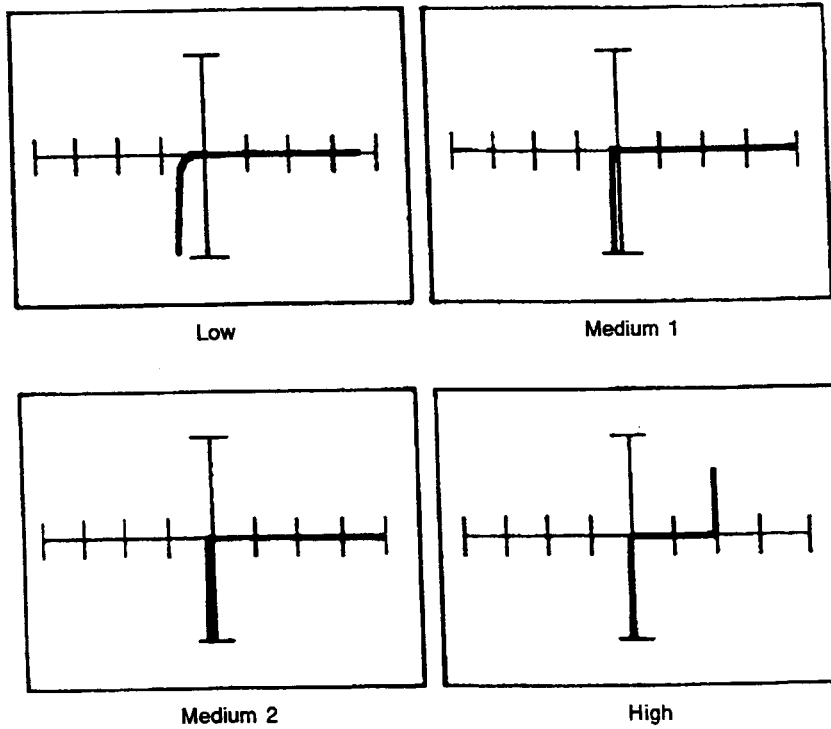

Figure 12-41. Signatures Between the Enable Pin and the Ground Pin of a 74LS125 at 60 Hz.

## TESTING INTEGRATED CIRCUITS

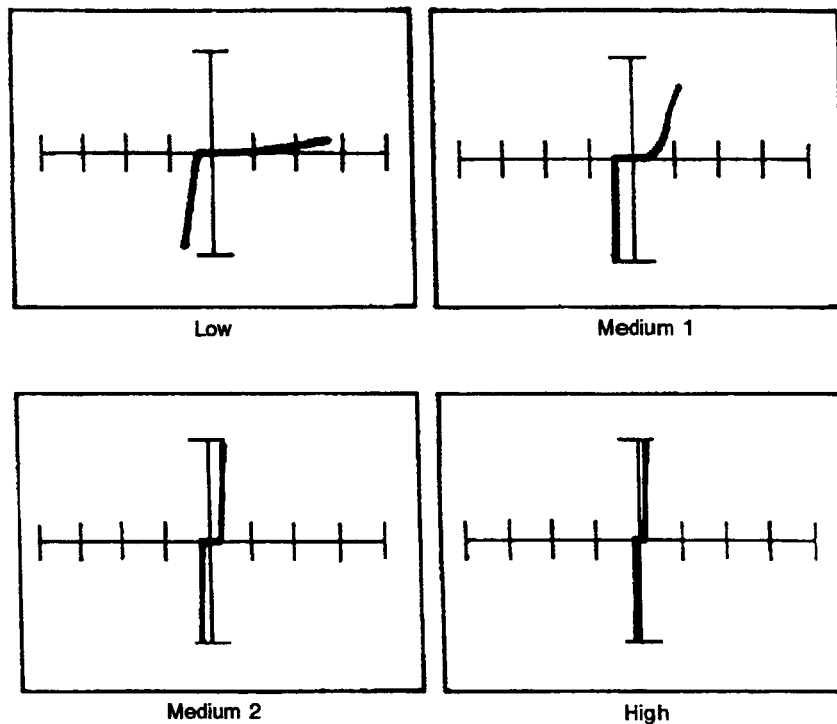

Figure 12-42. Signatures Between the  $V_{cc}$  Pin and the Ground Pin of a 74LS125 at 60 Hz.

## 12-14. CMOS INTEGRATED CIRCUITS

### CAUTION

**WHEN TESTING CMOS COMPONENTS BE SURE TO FOLLOW ALL STATIC HANDLING PRECAUTIONS. THESE INCLUDE:**

- Store and transport in conductive packaging.
- The person handling the device should be grounded with a  $1M\Omega$  wrist strap.
- All surfaces should dissipate static and be connected to earth ground.
- All parts should be handled by their packages and not by the leads.

*THESE ARE SOME OF THE MAJOR PRECAUTIONS-  
CHECK THE MANUFACTURER'S HANDLING TECHNIQUES  
FOR COMPLETE PROCEDURES.*

### 12-15. Quad NAND Gate

*NOTE: Tests were conducted in an independent laboratory to show that the Tracker test signals are safe to test CMOS, MOS, and low power Schottky devices. Refer to the Appendixes at the back of this manual.*

*NOTE: When testing CMOS devices, it is recommended that the  $V_{SS}$  and  $V_{DD}$  pins be shorted together to eliminate instability in the 2000 signatures.*

The CMOS IC has become very popular because of its low power consumption and high noise immunity. Figure 12-43 shows the schematic and pin layout of a 4011B CMOS NAND gate. All CMOS input pins have protection diodes which have fairly high DC resistance. Figures 12-44 through 12-45 show the signatures between different pins of the 4011B. Figure 12-44 shows the signatures between an input pin and  $V_{SS}$ - $V_{DD}$  of the 4011B. In the low range, the signatures do not look like that of a regular diode because of the high input resistance in series with the protection diodes.

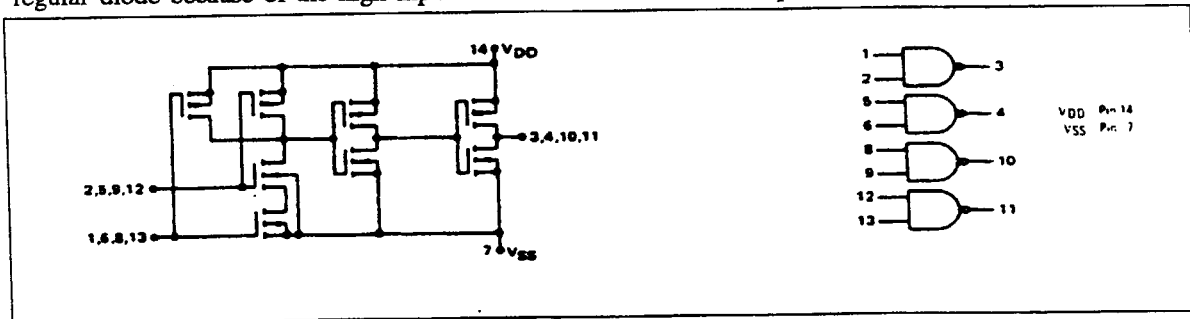

Figure 12-43. Schematic and Pin Layout of a 4011B.

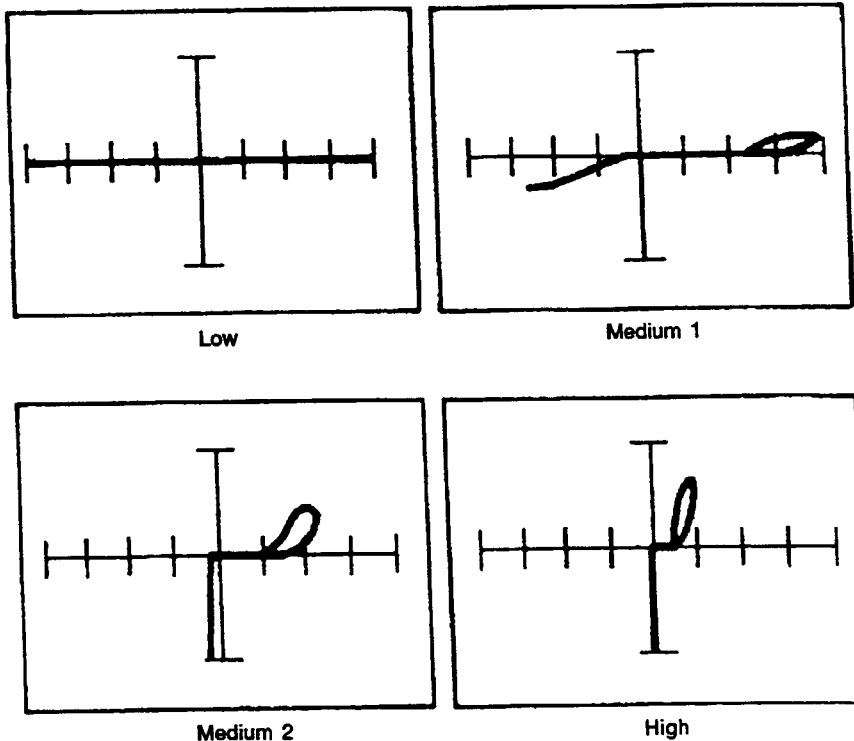

Figure 12-44. Signatures Between an Input Pin and  $V_{SS}$ - $V_{DD}$  of a 4011B at 60 Hz.

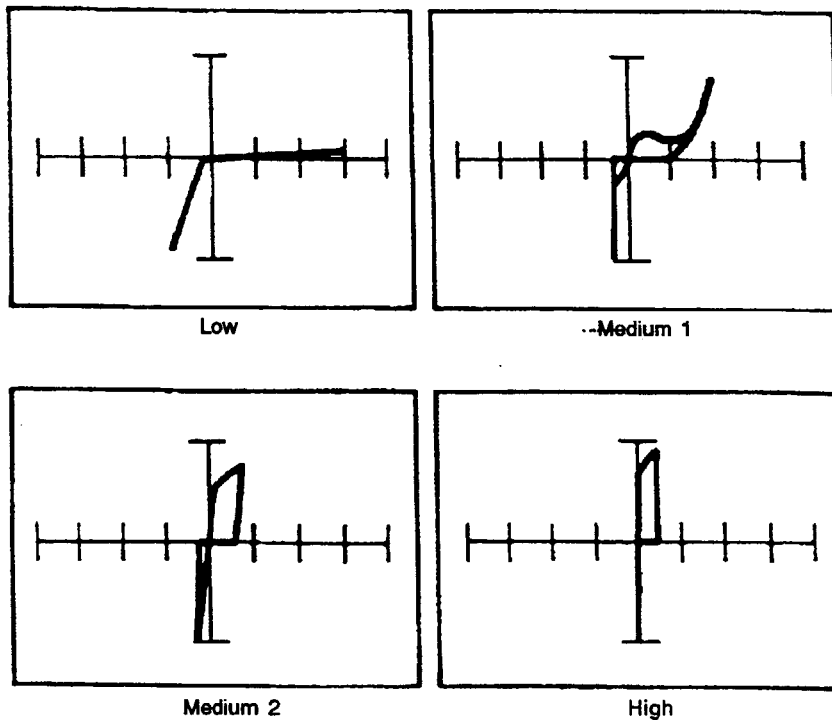

Figure 12-45. Signature Between an Output Pin and  $V_{SS}$ - $V_{DD}$  of a 4011B at 60 Hz.

### 12-16. Analog Switch

The 4016B quad bilateral switch is constructed with MOS P-channel and N-channel enhancement mode devices in a single monolithic structure. Each 4016B consists of four independent switches capable of controlling either digital or analog signals. The quad bilateral switch is used in signal gating, chopper, modulator, demodulator, and CMOS logic implementation.

To test a 4016B analog switch we need to examine the input, output, and control pins with respect to  $V_{SS}$ - $V_{DD}$ . Figures 12-47 through 12-49 show the signatures of a good 4016B analog switch. Figure 12-50 exhibits the signatures of a defective 4016B. Comparing Figure 12-47 to Figure 12-50, the signatures show a significant difference between a good device and a defective device.

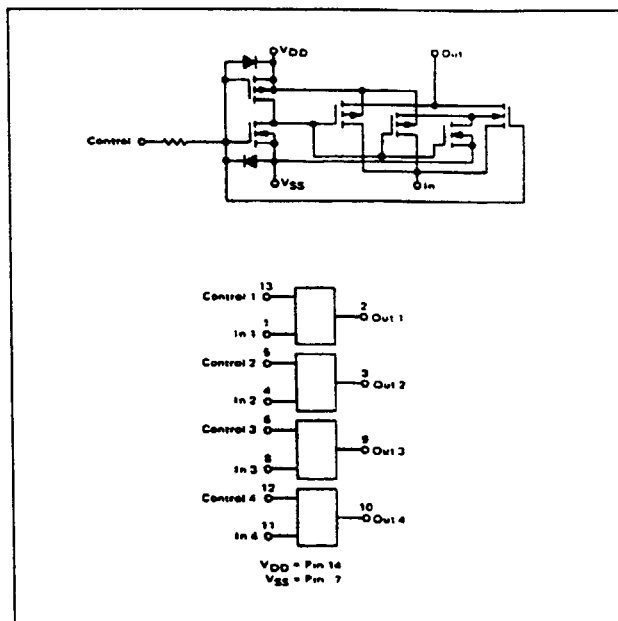

Figure 12-46. Schematic and Pin Layout of a 4016B.

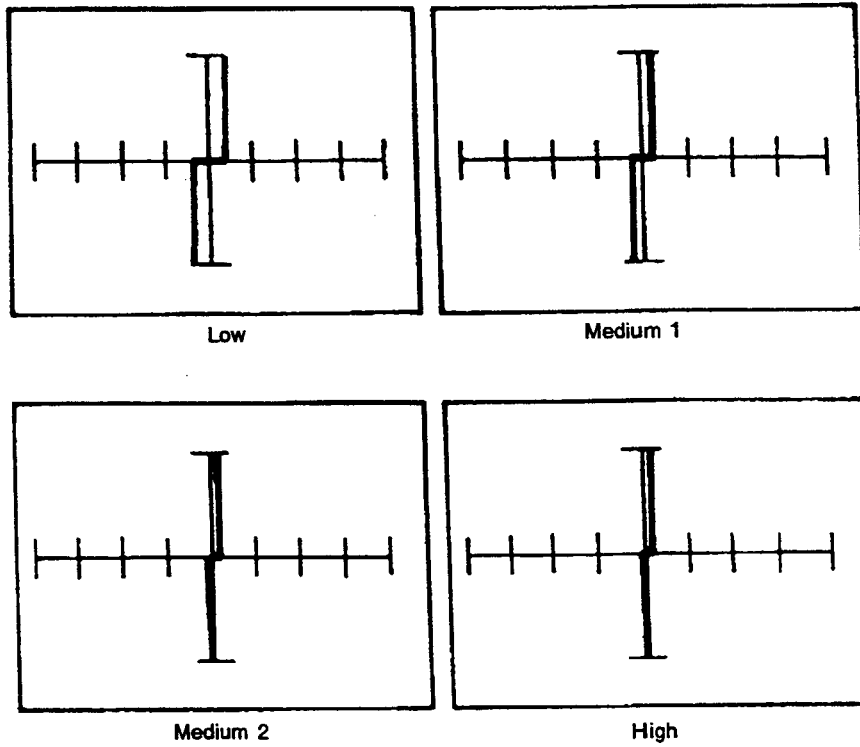

Figure 12-47. Signatures Between an Input Pin and  $V_{ss}$ - $V_{dd}$  of a 4016B at 60 Hz.

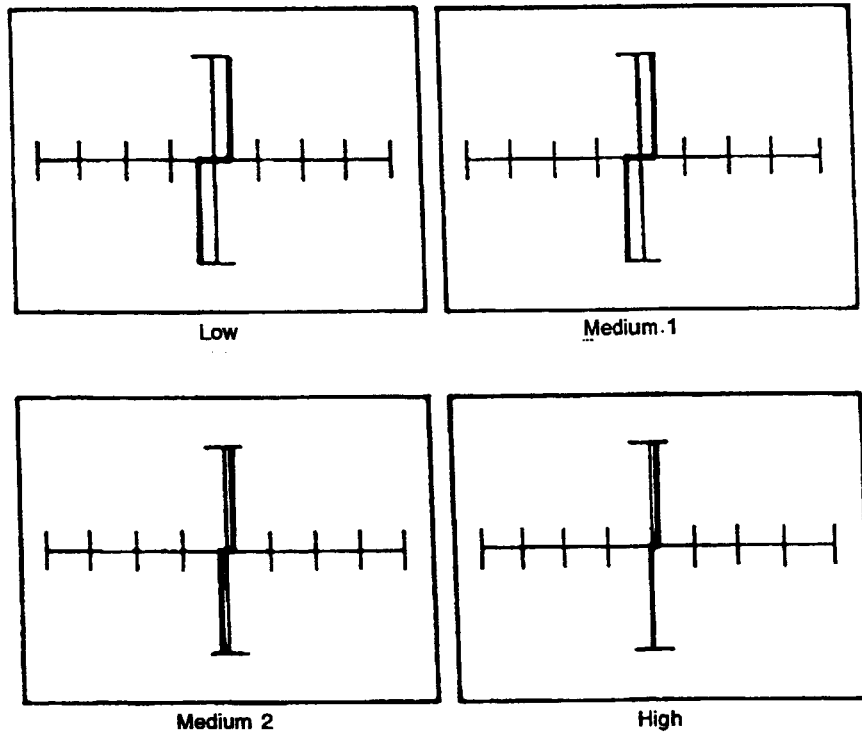

Figure 12-48. Signatures Between an Output Pin and  $V_{ss}$ - $V_{dd}$  of a 4016B at 60 Hz.

TESTING INTEGRATED CIRCUITS

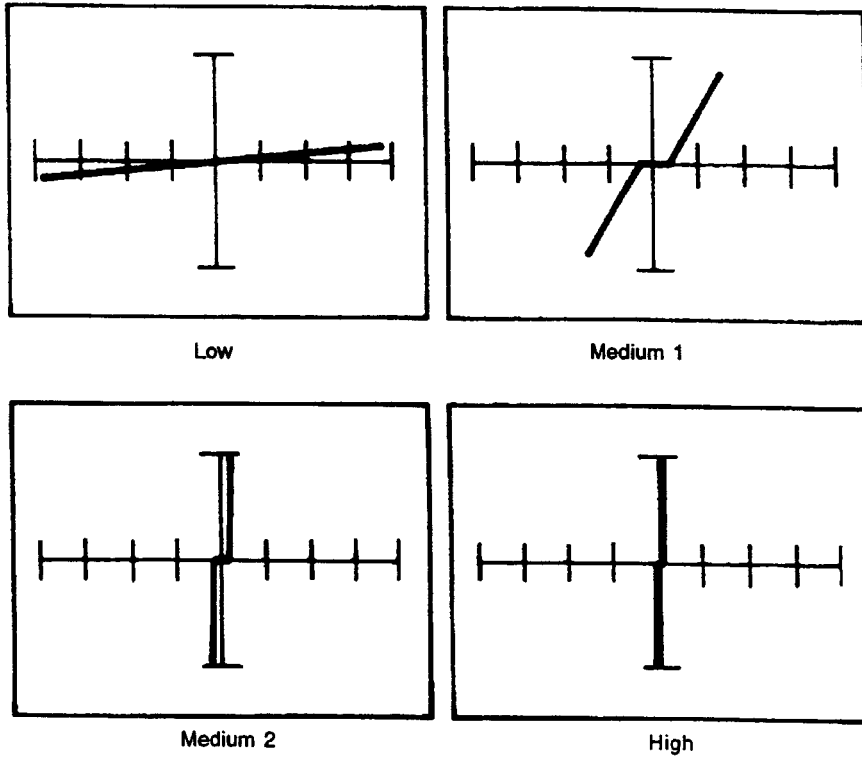

Figure 12-49. Signatures Between a Control Pin and  $V_{ss}$ - $V_{dd}$  of a 4016B at 60 Hz.

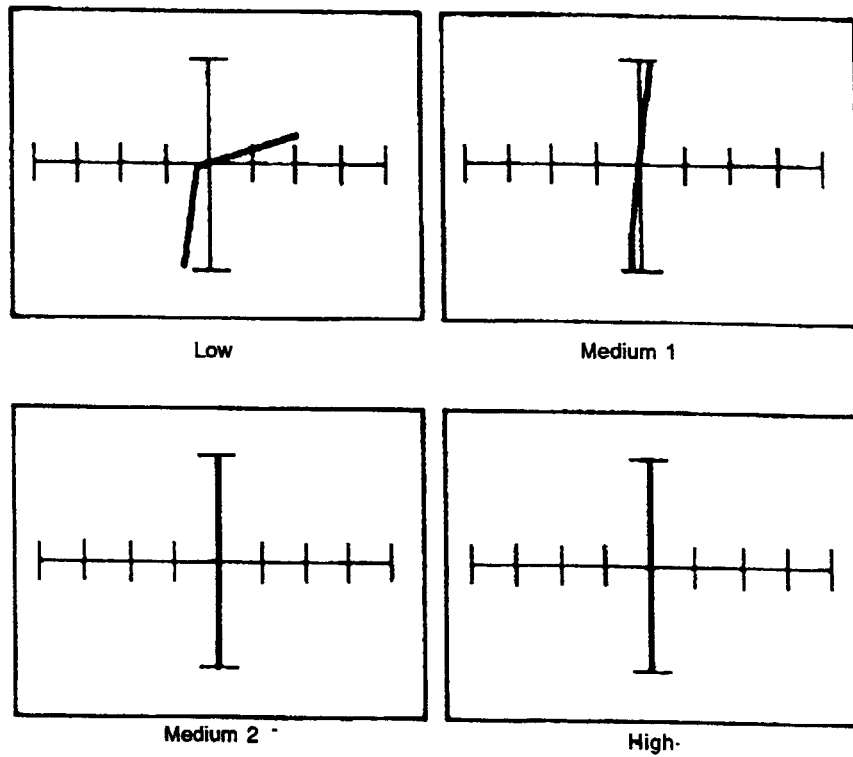

Figure 12-50. Signatures Between an Input Pin and  $V_{ss}$ - $V_{dd}$  of a Defective 4016B at 60 Hz.

### 12-17. MOS STATIC RAM

The 2114A is a 4096 bit static Random Access Memory (RAM) organized as 1024 words by 4 bits using HMOS, a high performance MOS technology. It uses fully DC stable (static) circuitry throughout, both in array and decoding.

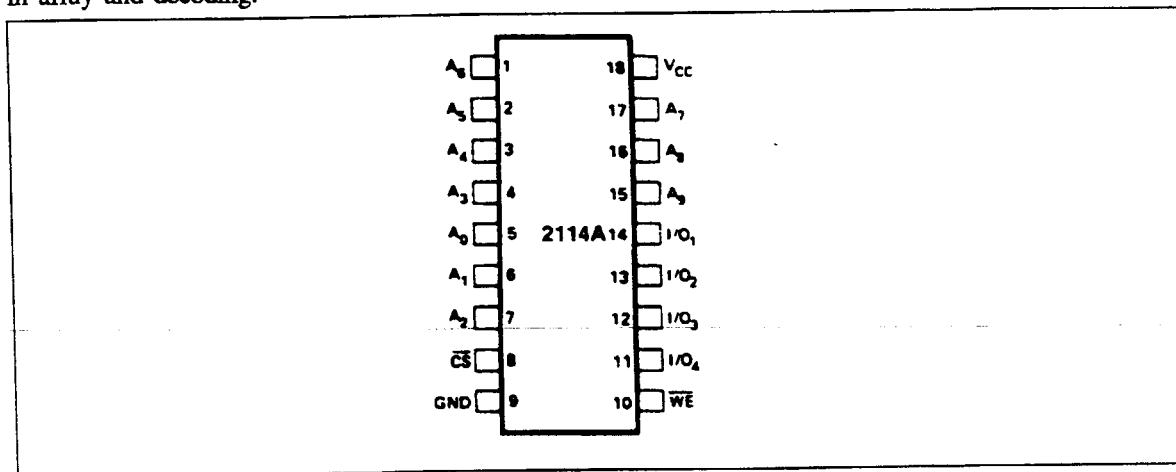

Figure 12-51. Pin Layout of a 2114A Static RAM.

Figures 12-52 through 12-56 show the signatures of the Address, CS, WE, I/O, and  $V_{cc}$  pins with respect to the ground pin. Signatures of the Address, CS, and WE are similar because they have similar fabrication structure.

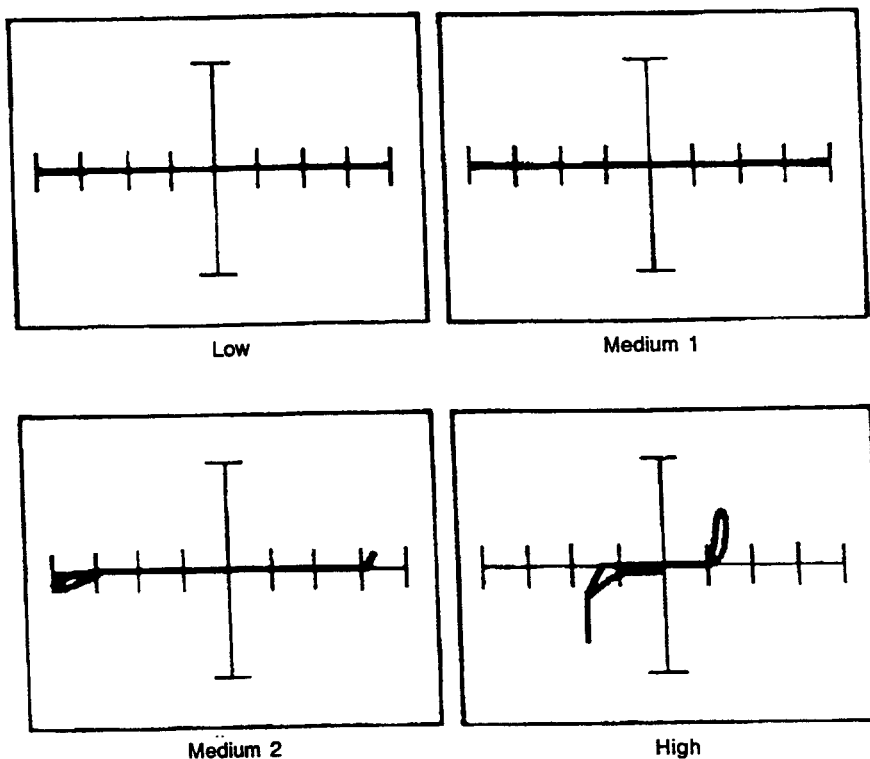

Figure 12-52. Signatures Between an Address Pin and the Ground Pin of a 2114A Static RAM at 60 Hz.

TESTING INTEGRATED CIRCUITS

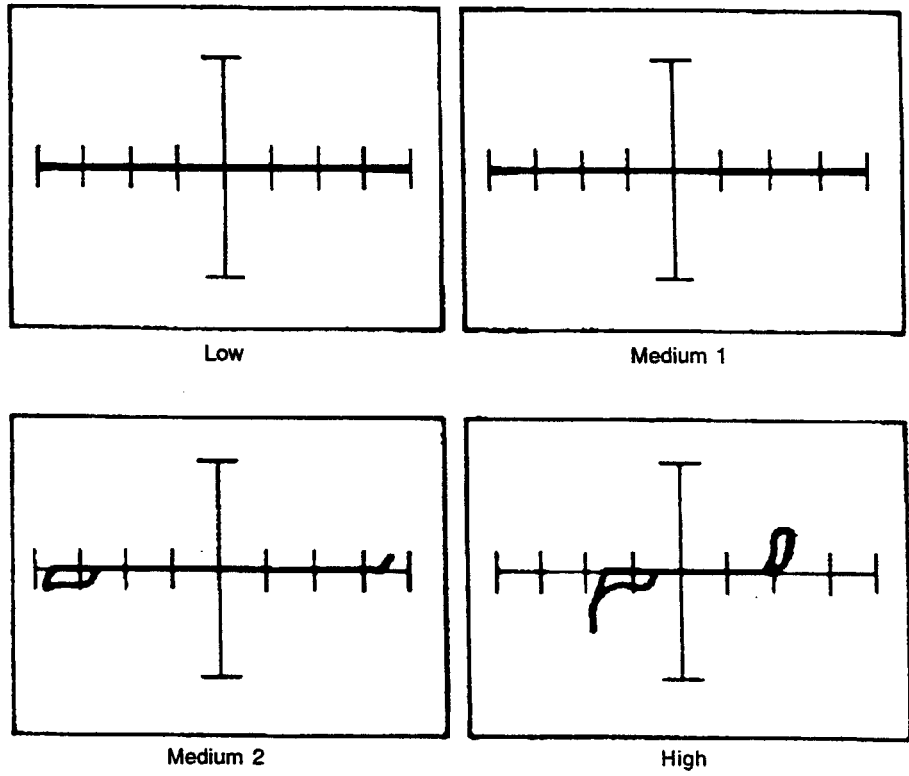

Figure 12-53. Signatures Between the CS Pin and the Ground Pin of a 2114A Static RAM at 60 Hz.

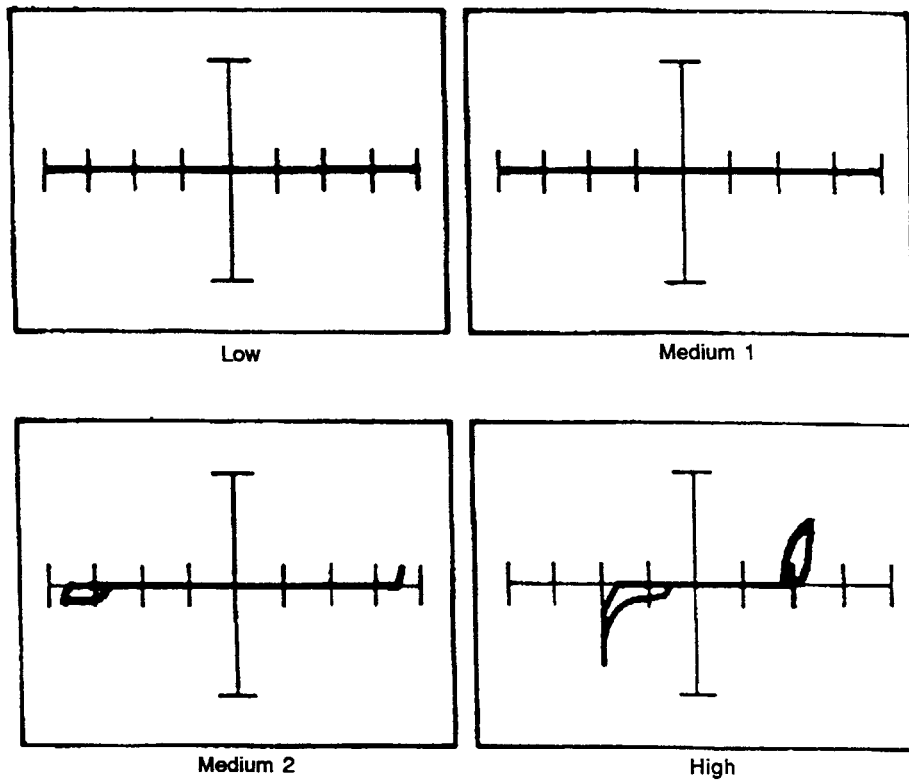

Figure 12-54. Signatures Between the WE Pin and the Ground Pin of a 2114A Static RAM at 60 Hz.



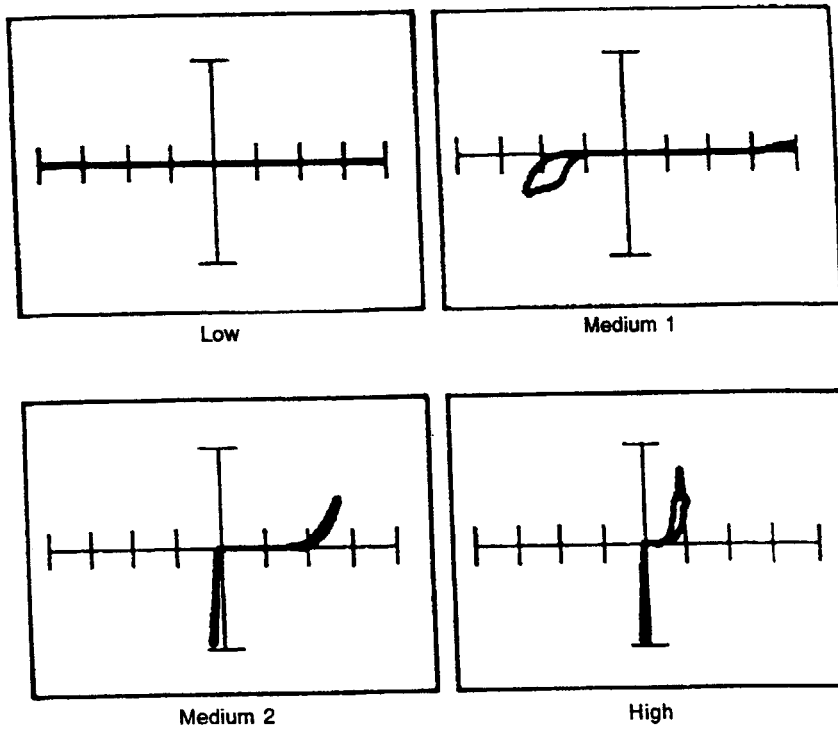

Figure 12-55. Signatures Between an I/O Pin and the Ground Pin of a 2114A Static RAM at 60 Hz.

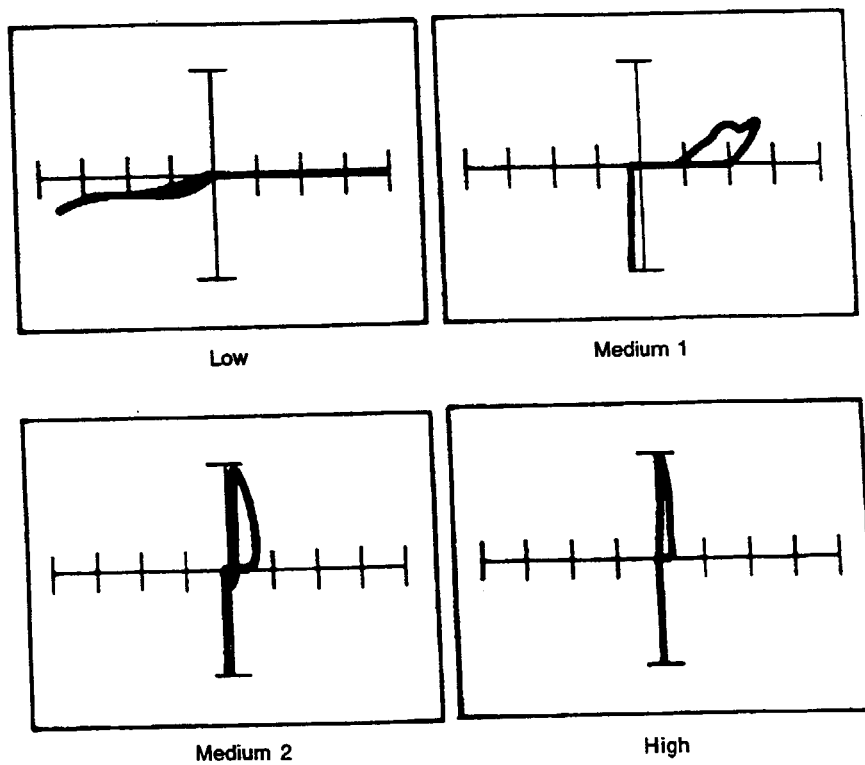

Figure 12-56. Signatures Between the  $V_{cc}$  Pin and the Ground Pin of a 2114A Static RAM at 60 Hz.

### 12-18. EPROM

The 2708JL is an ultraviolet light erasable, electrically programmable read only memory (EPROM). The 2708JL has 8192 bits organized as 1024 words of 8 bit length. These devices are fabricated using N-channel silicon gate technology for high speed and simple interface with MOS and bipolar circuits. The data outputs for all three circuits are tri-state for connecting multiple devices on a common bus. The pin layout of a 2708JL is shown in Figure 12-57. The signatures of various pins with respect to  $V_{SS}$  are shown in Figures 12-58 through 12-64. Signatures may vary from manufacturer to manufacturer. In general, however, the signatures will be similar.

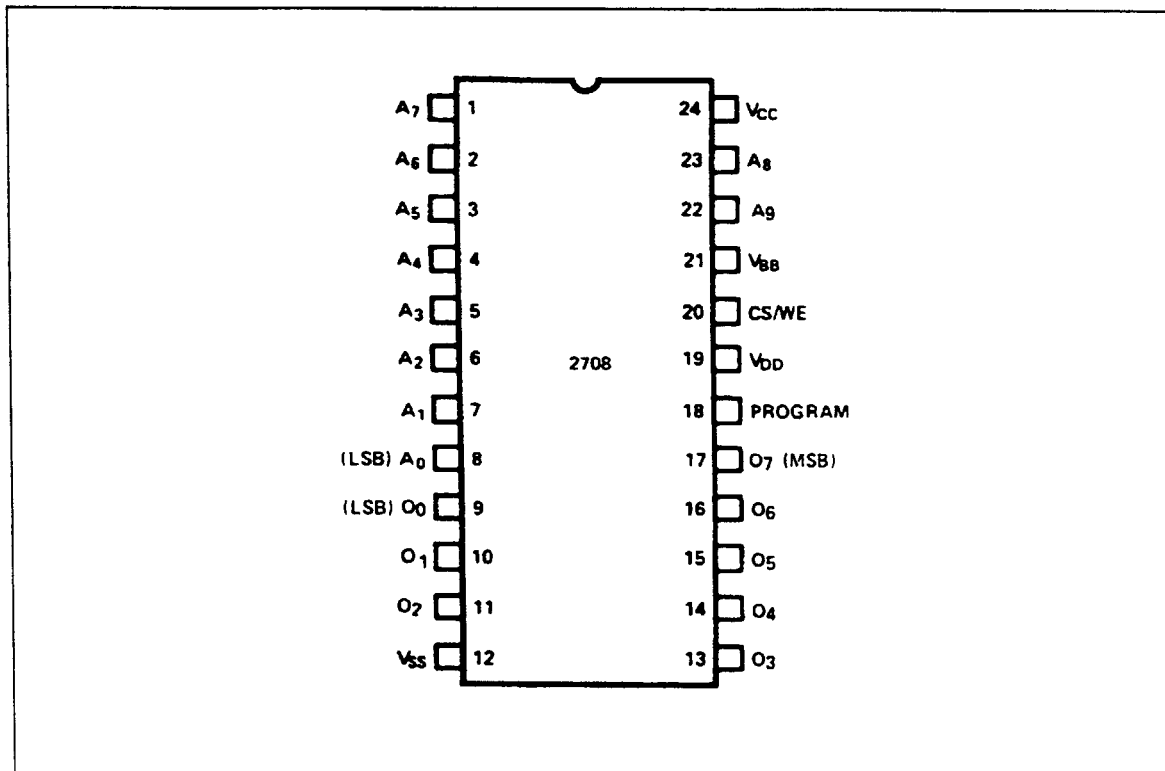

Figure 12-57. Pin Layout of a 2708JL

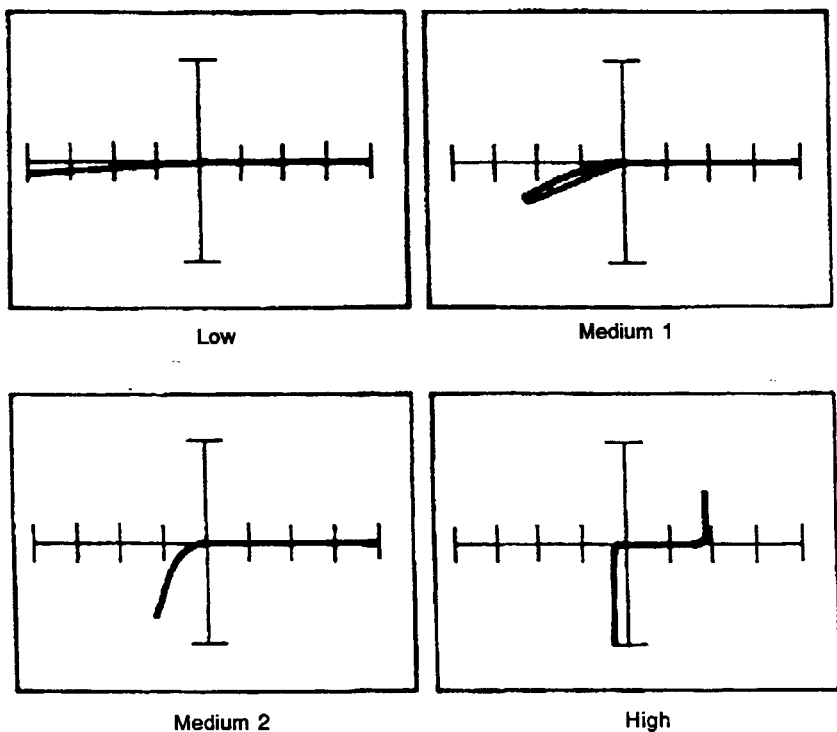

Figure 12-58. Signatures Between an Address Pin and the  $V_{ss}$  Pin of a 2708JL at 60 Hz.

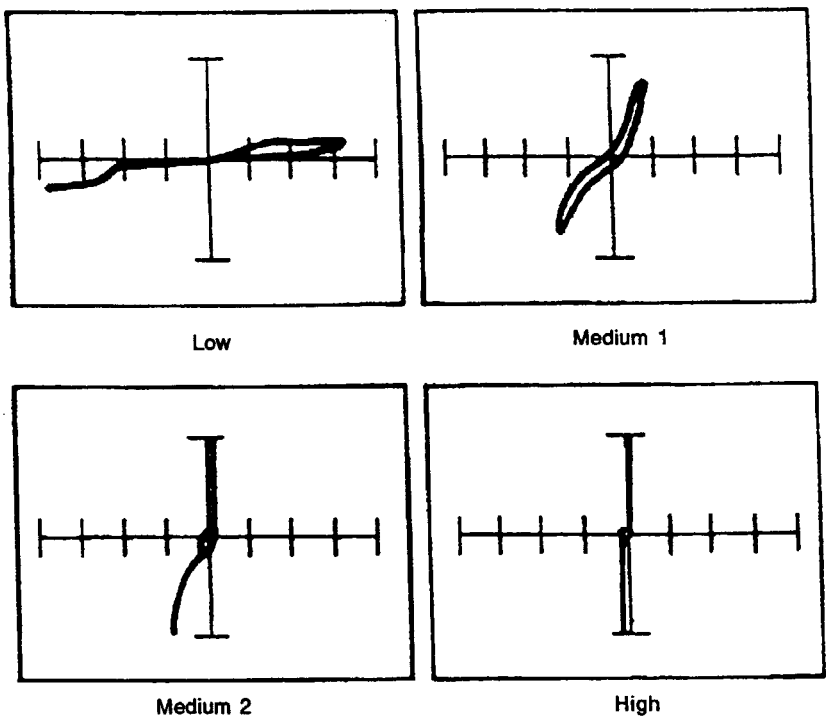

Figure 12-59. Signatures Between an Output Pin and the  $V_{ss}$  Pin of a 2708JL at 60 Hz.

TESTING INTEGRATED CIRCUITS

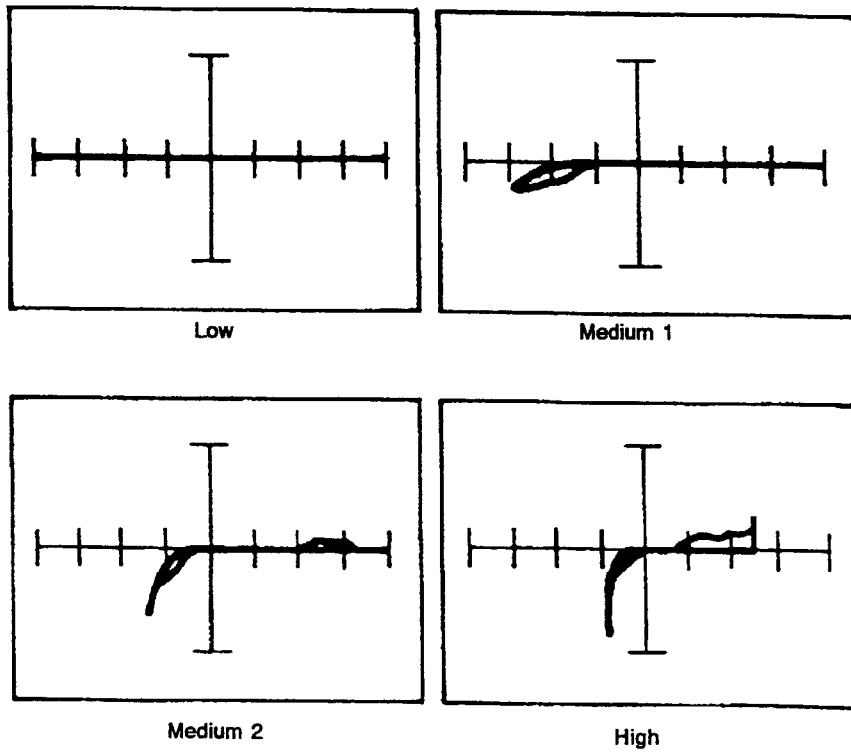

Figure 12-60. Signatures Between the Program Pin and the V<sub>SS</sub> Pin of a 2708JL at 60 Hz.

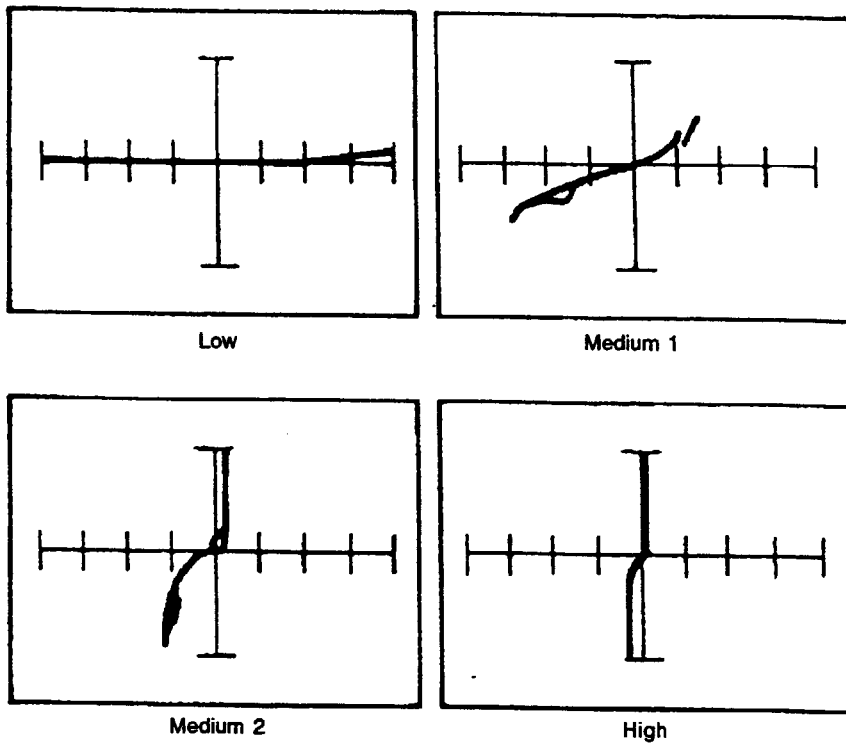

Figure 12-61. Signatures Between the V<sub>DD</sub> Pin and the V<sub>SS</sub> Pin of a 2707JL at 60 Hz.

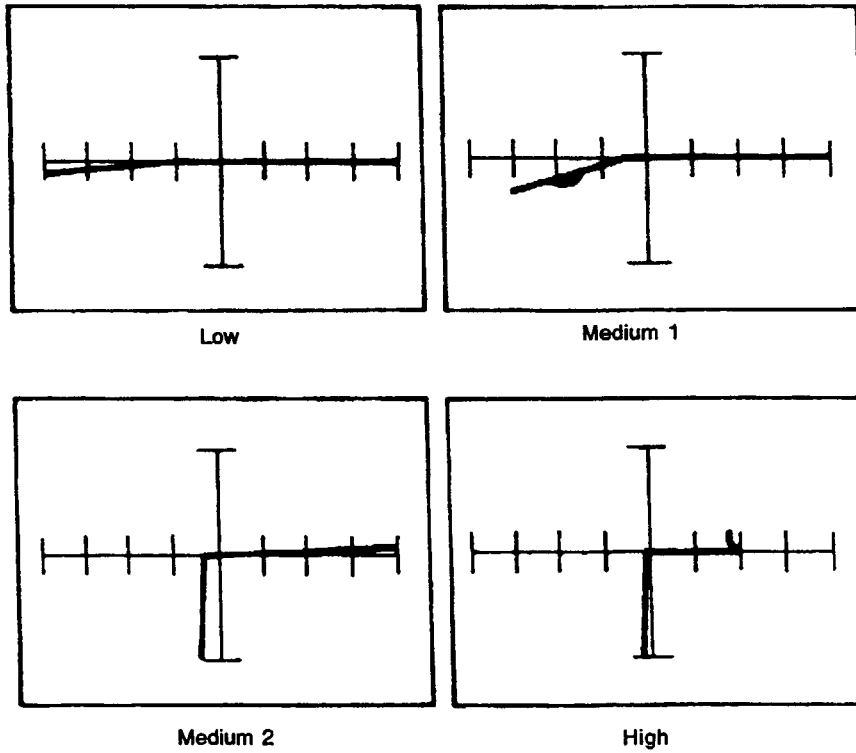

Figure 12-62. Signatures Between the CS Pin and the  $V_{SS}$  Pin of a 2708JL at 60 Hz.

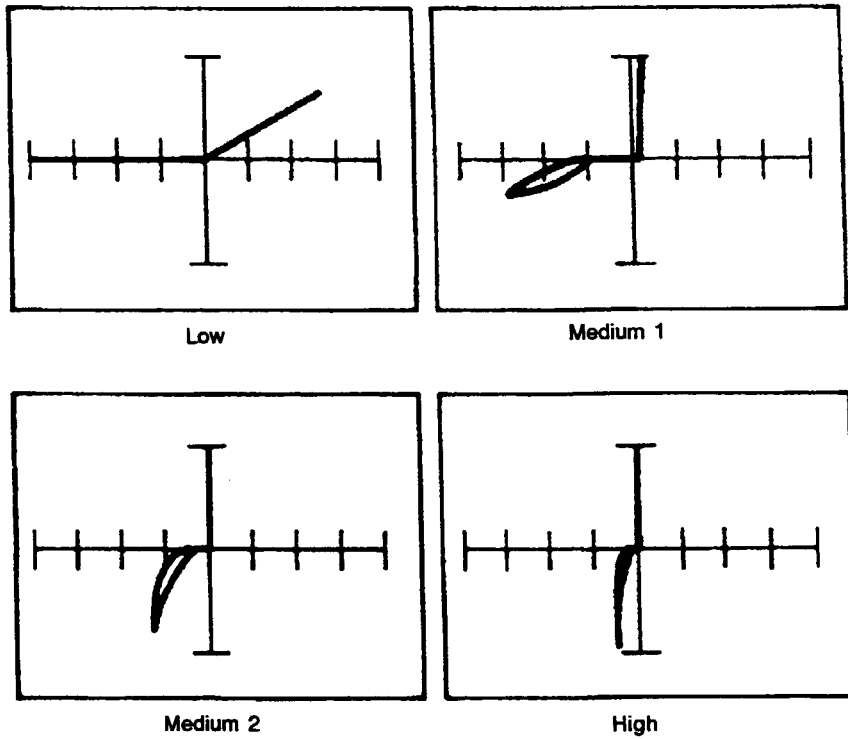

Figure 12-63. Signatures Between the  $V_{bb}$  Pin and the  $V_{SS}$  Pin of a 2708JL at 60 Hz.

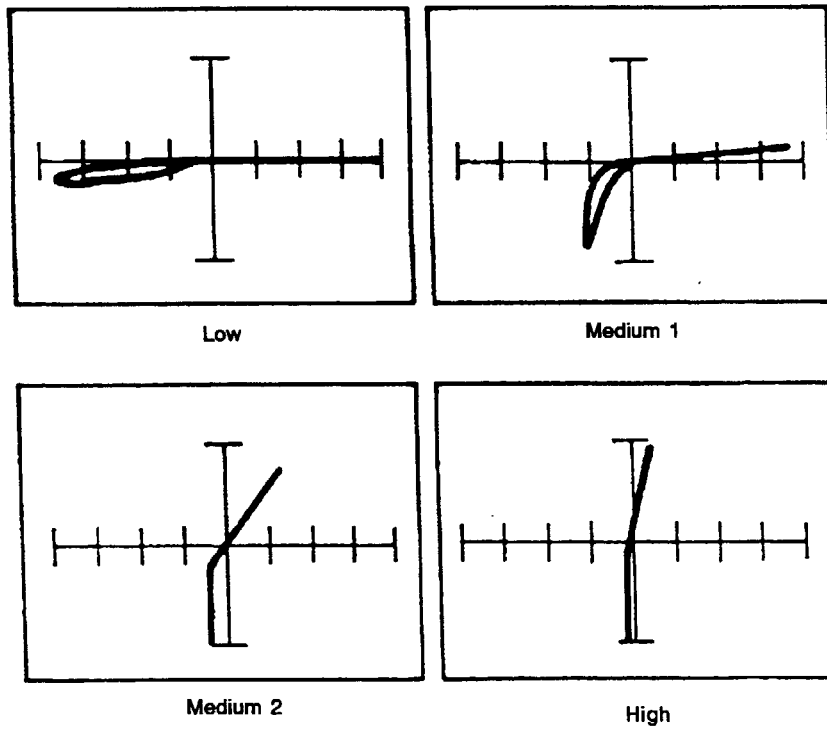

Figure 12-64. Signatures Between the  $V_{cc}$  Pin and the  $V_{ss}$  Pin of a 2708JL at 60 Hz.

### 12-19. BIPOLAR PROM

The Monolithic Memories 6301-1J is a 256 x 4 PROM with tri-state outputs. It is implemented with standard Schottky technology. The pin layout of a 6301-1J is shown in Figure 12-65. The signatures of various pins with respect to ground are shown in Figures 12-66 through 12-69.

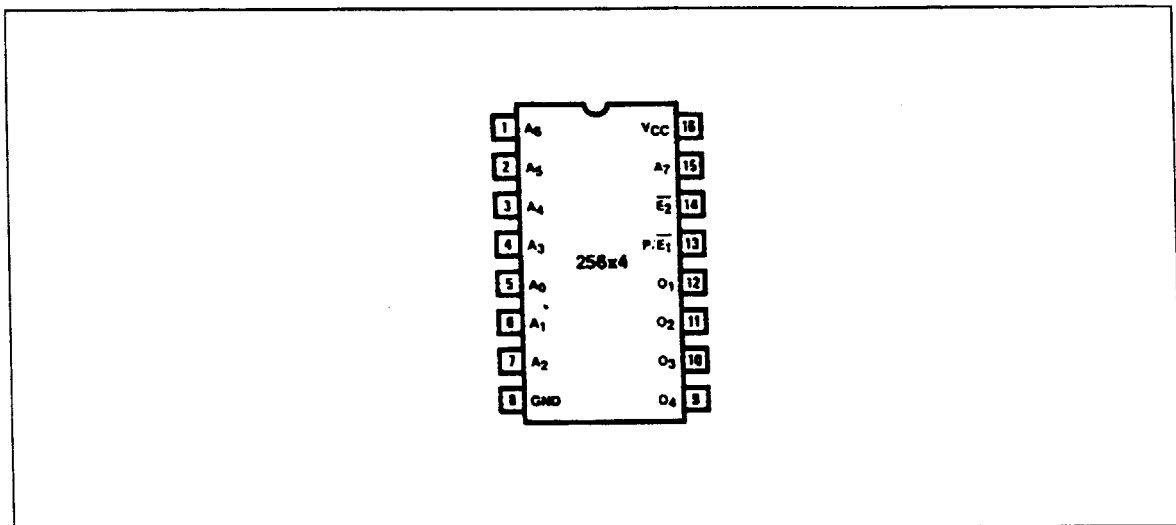

Figure 12-65. Pin Layout of a 6301-1J.

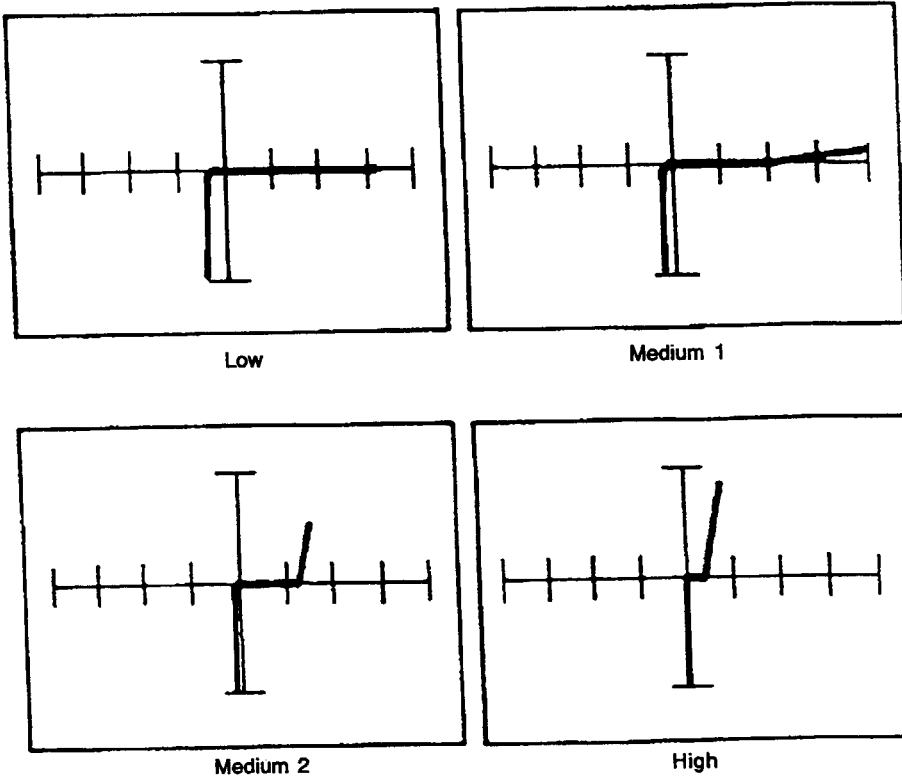

Figure 12-66. Signatures Between an Address Pin and the Ground Pin of a 6301-1J at 60 Hz.

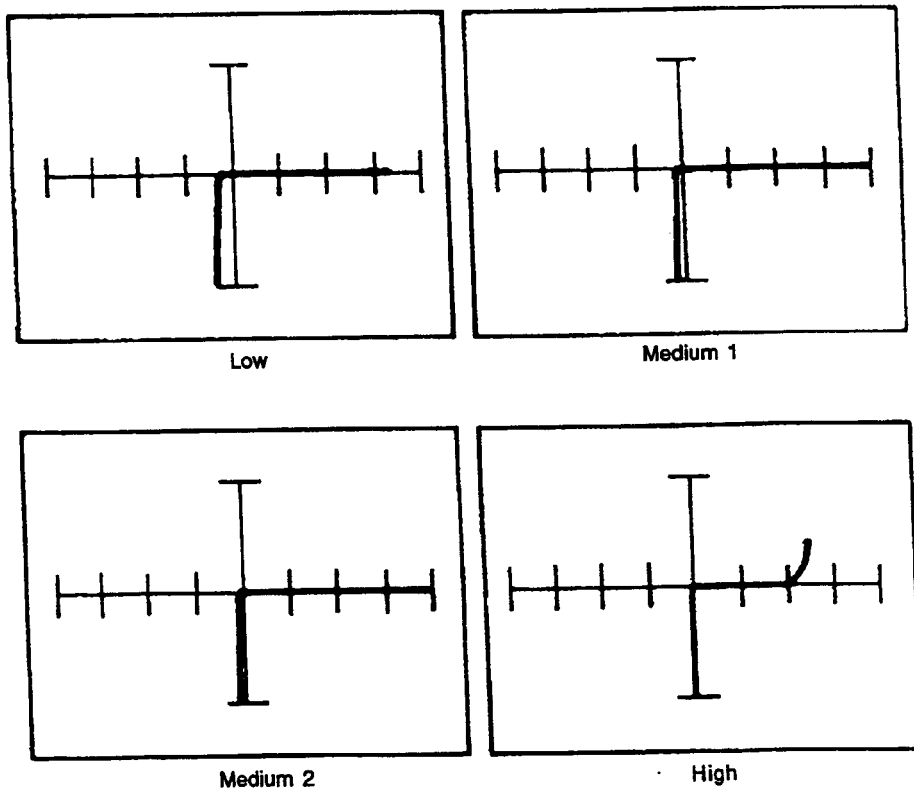

Figure 12-67. Signatures Between an Output Pin and the Ground Pin of a 6301-1J at 60 Hz.

TESTING INTEGRATED CIRCUITS

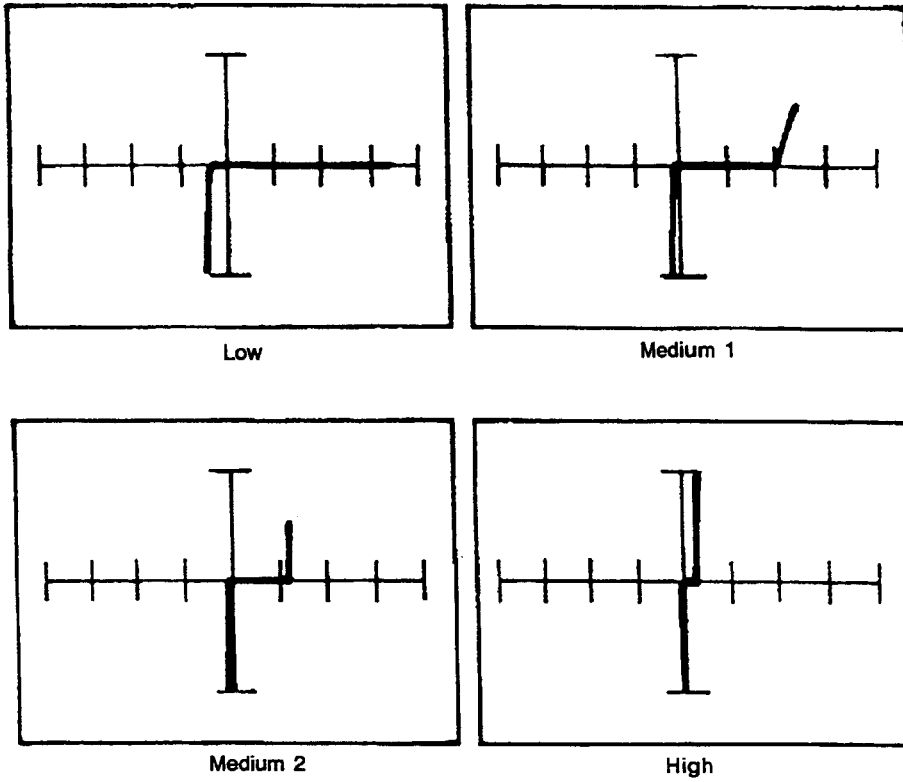

Figure 12-68. Signatures Between the E2 Pin and the Ground Pin of a 6301-1J at 60 Hz.

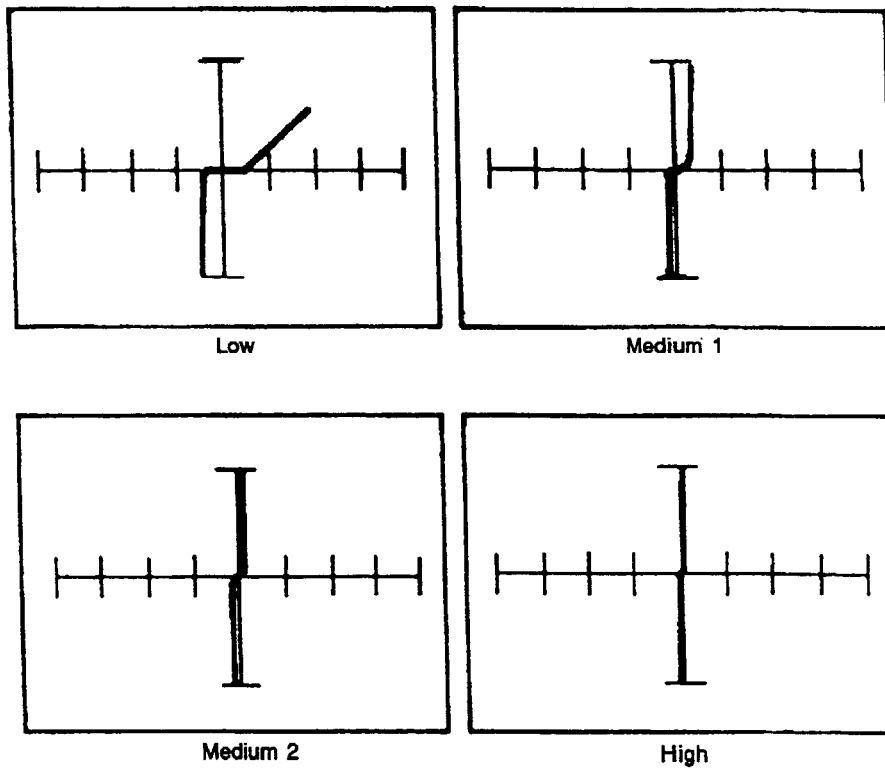

Figure 12-69. Signatures Between the Vcc Pin and the Ground Pin of a 6301-1J at 60 Hz.



12-20. DIGITAL TO ANALOG CONVERTER

The National DAC0800L is a monolithic, 8 bit, high speed, current output, digital to analog converter (DAC) implemented with bipolar technology. Figure 12-70 shows the pin layout and equivalent circuit of a DAC0800L. The signatures of various pins with respect to  $V^-$  are shown in Figures 12-71 through 12-77.

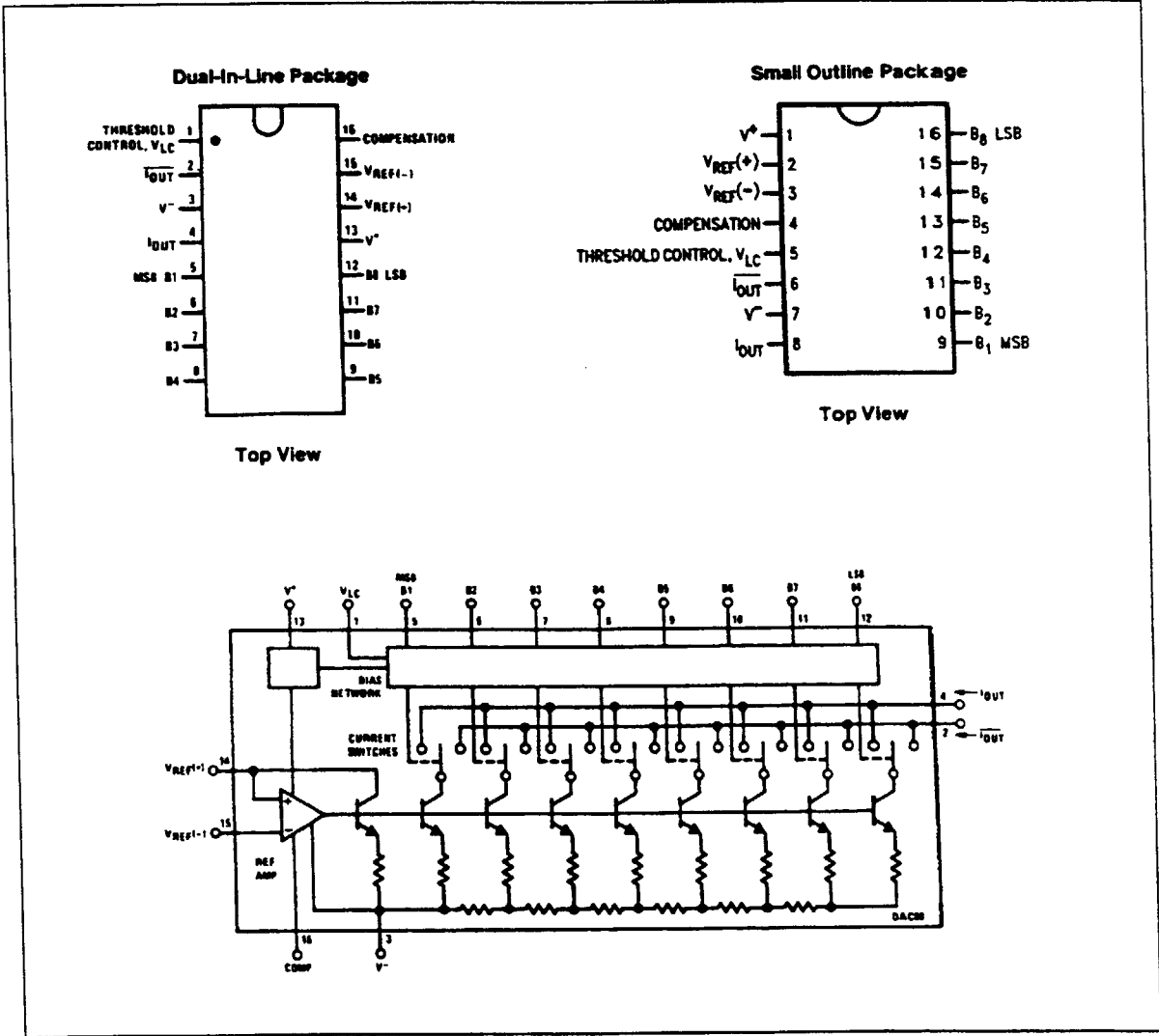

Figure 12-70. Pin Layout and the Equivalent Circuit of a DAC0800L.

TESTING INTEGRATED CIRCUITS

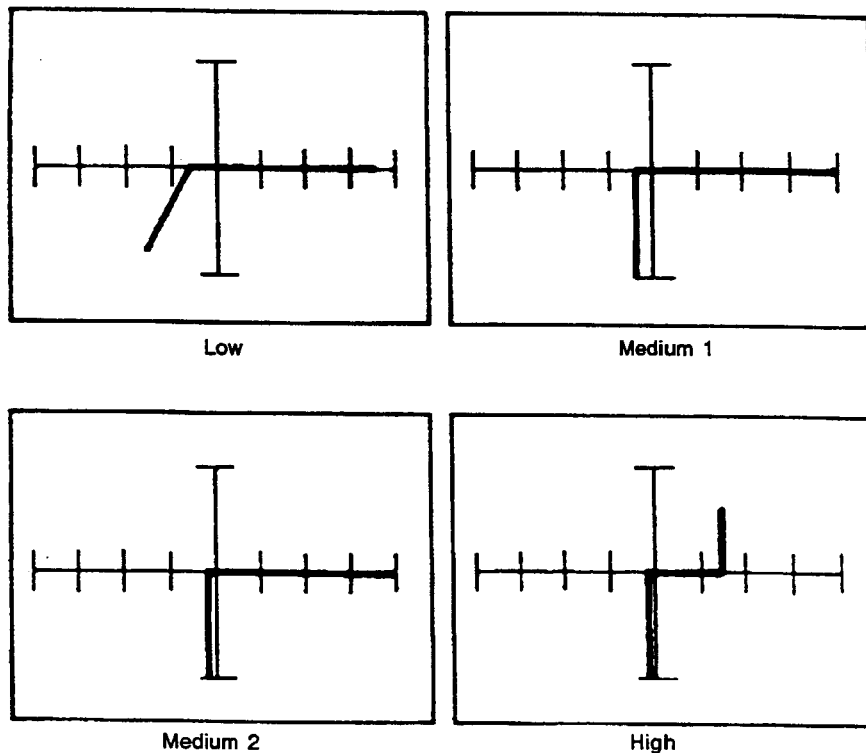

Figure 12-71. Signatures Between the  $V_{Lc}$  Pin and the  $V$  Pin of a DAC0800L at 60 Hz.

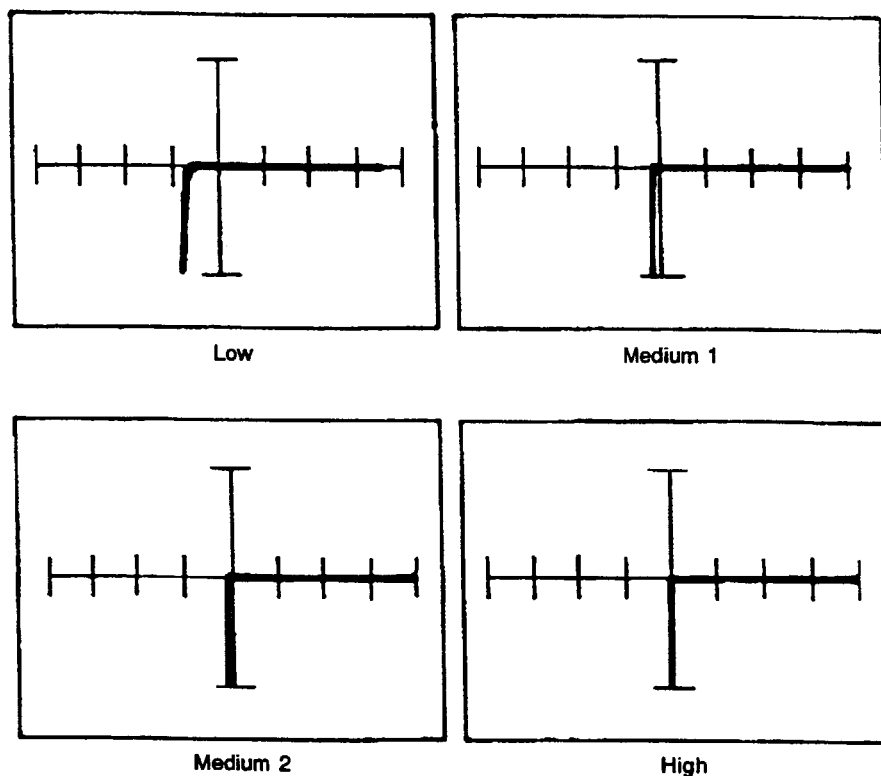

Figure 12-72. Signatures Between the  $I_{out}$  Pin and the  $V$  Pin of a DAC0800L at 60 Hz.

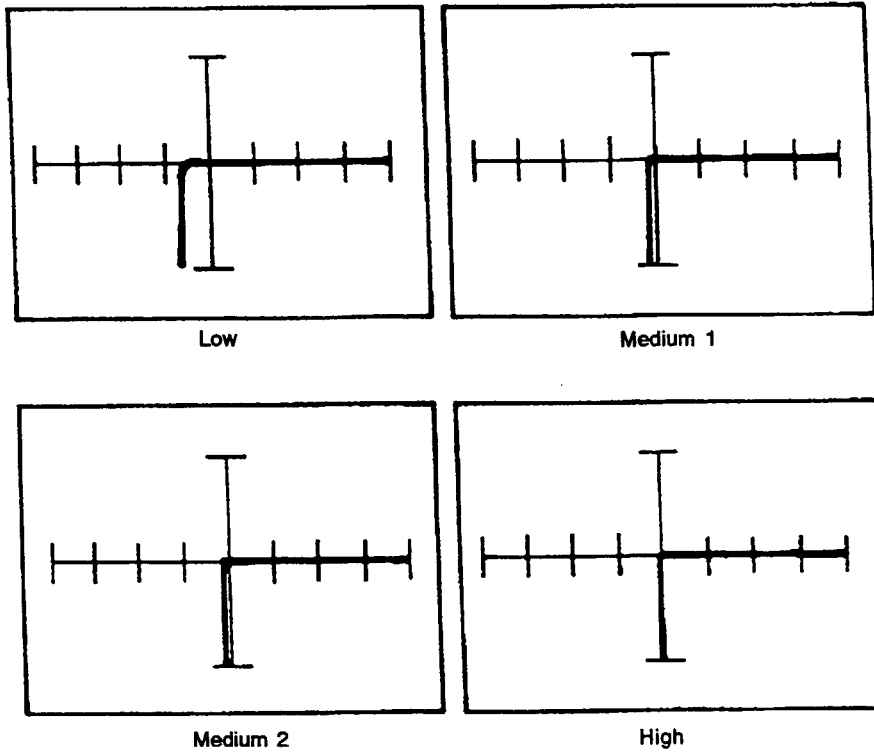

Figure 12-73. Signatures Between a Digital Input Pin and the  $V^-$  Pin of a DAC0800L at 60 Hz.

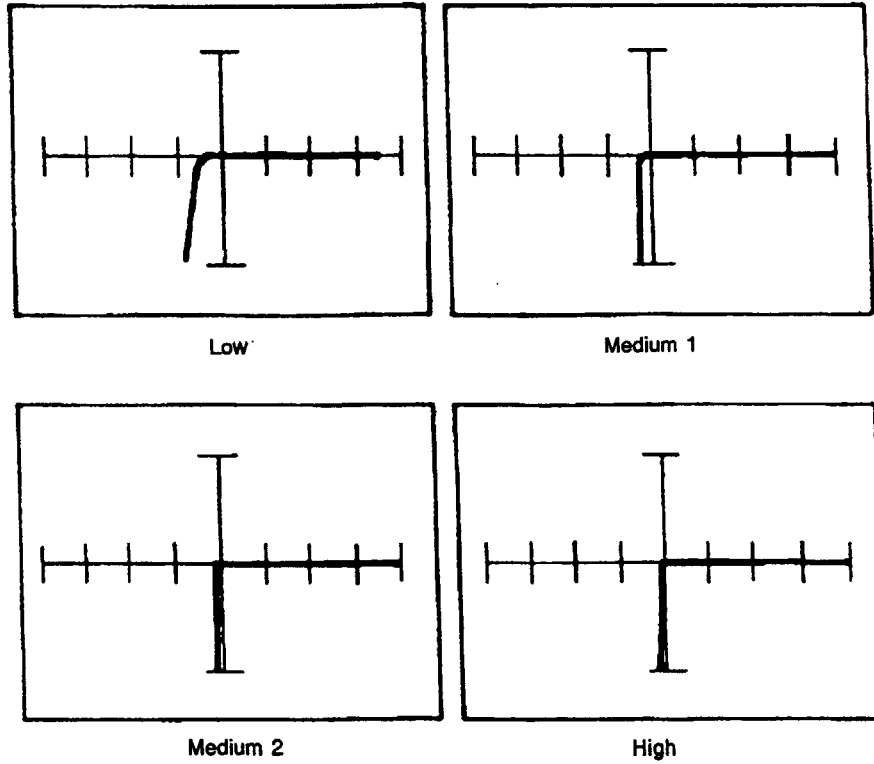

Figure 12-74. Signatures Between the  $V_{ref}(+)$  Pin and the  $V^-$  Pin of a DAC0800L at 60 Hz.

TESTING INTEGRATED CIRCUITS

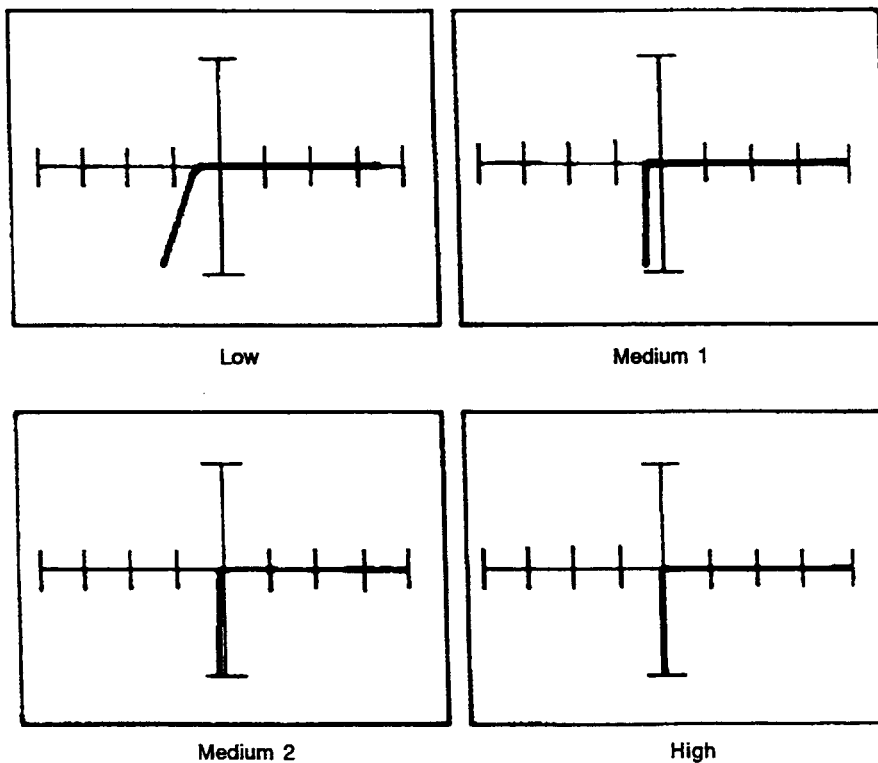

Figure 12-75. Signatures Between the  $V_{ref(-)}$  Pin and the  $V$  Pin of a DAC0800L at 60 Hz.

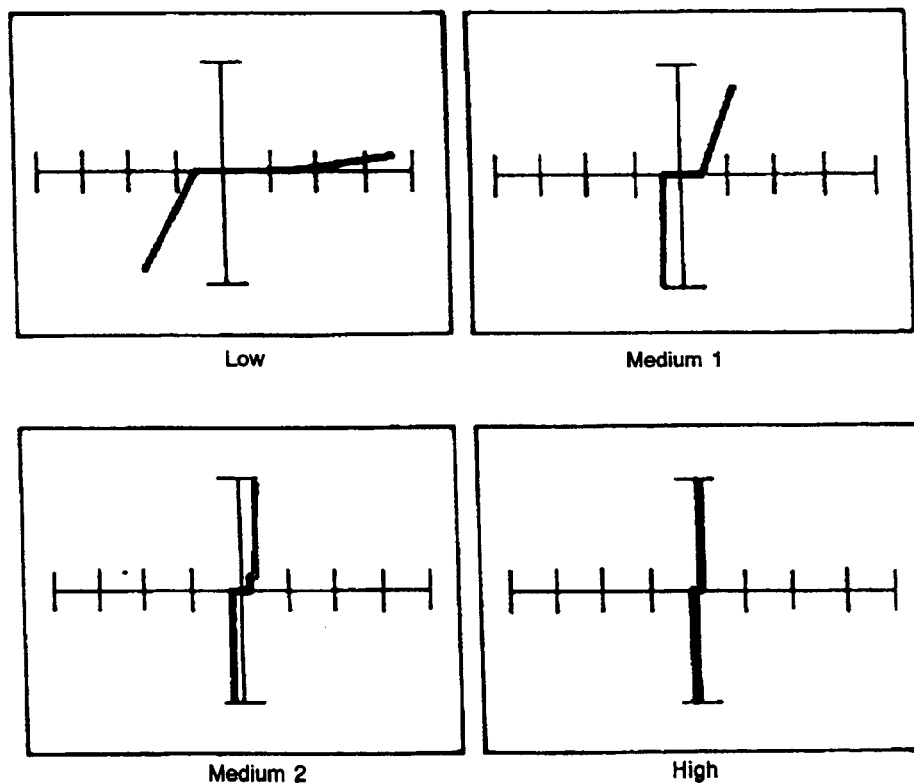

Figure 12-76. Signatures Between the Compensation Pin and the  $V$  Pin of a DAC0800L at 60 Hz.

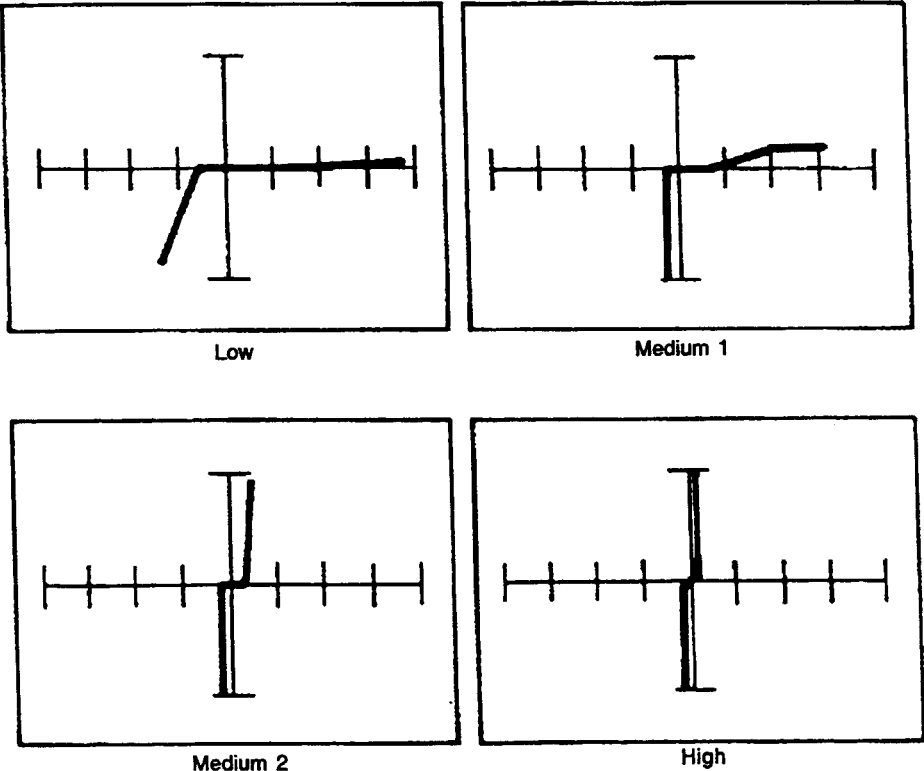

Figure 12-77. Signatures Between the  $V^+$  and  $V^-$  Pins of a DAC0800L at 60 Hz.

### 12-21. MICROPROCESSORS

The 8080A is an 8-bit parallel central processing unit (CPU). It is fabricated on a single LSI chip using an N-channel silicon gate MOS process. Figure 12-78 shows the pin layout of an 8080A microprocessor.

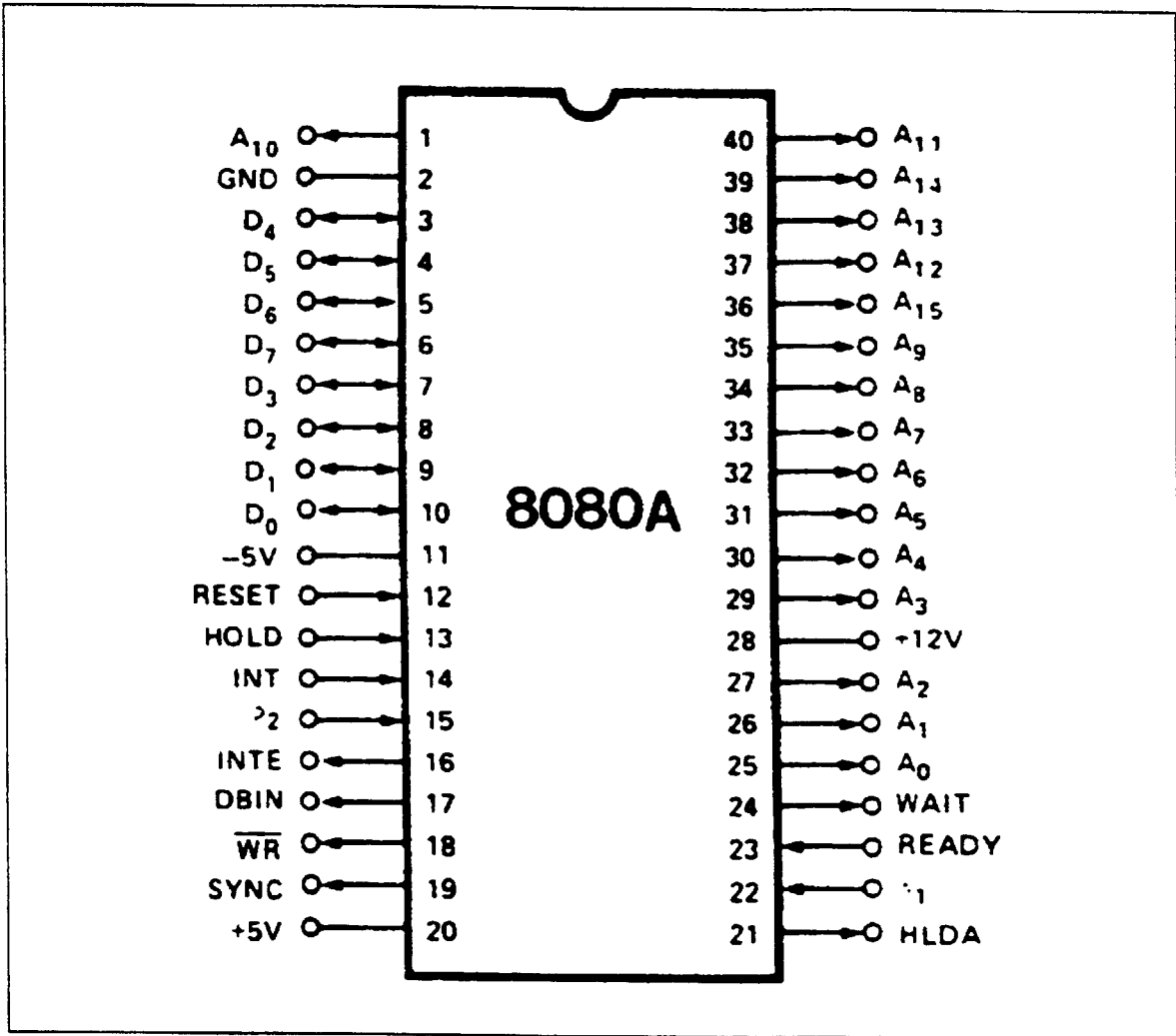

Figure 12-78. Pin Layout of an 8080A.

The signatures of various pins with respect to the -5V pin are shown in Figures 12-79 through 12-84.

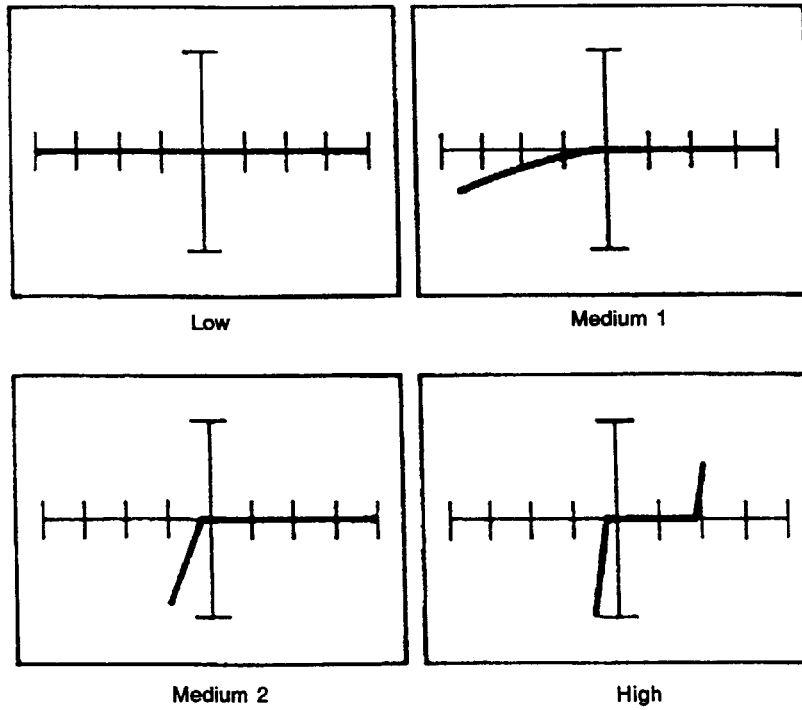

Figure 12-79. Signatures Between an Address Pin and the -5V Pin of an 8080A at 60 Hz.

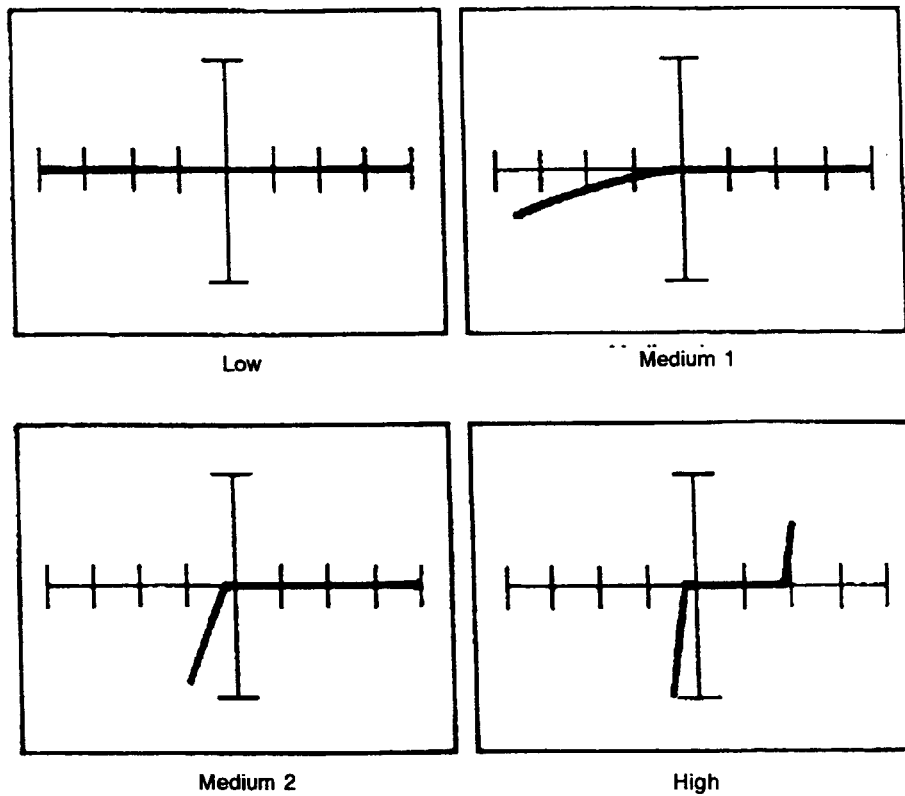

Figure 12-80. Signatures Between a Data Pin and the -5V Pin of an 8080A at 60 Hz.

TESTING INTEGRATED CIRCUITS

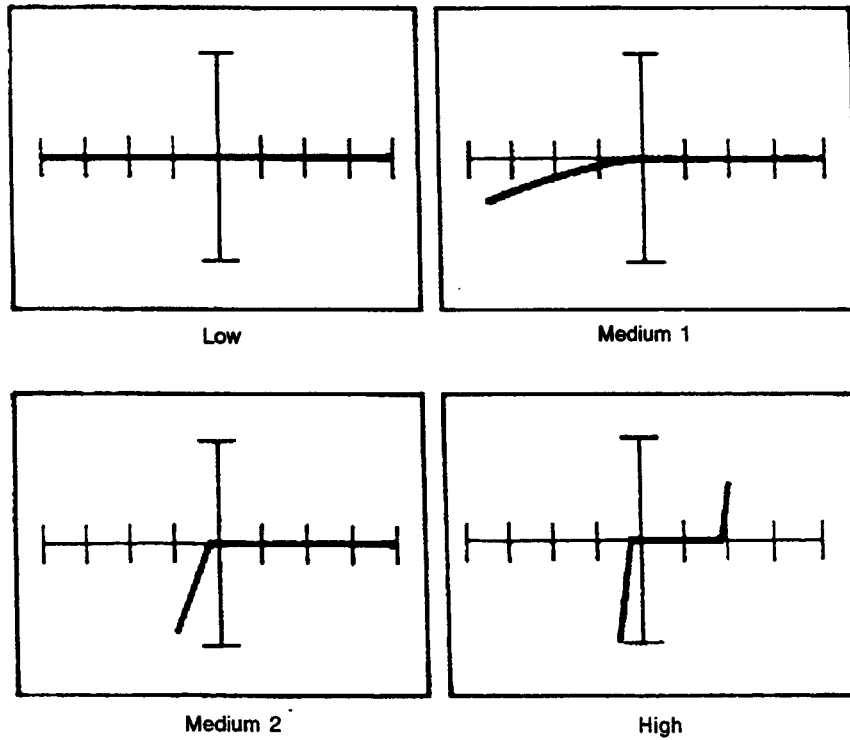

Figure 12-81. Signatures Between the Reset Pin and the -5V Pin of an 8080A at 60 Hz.

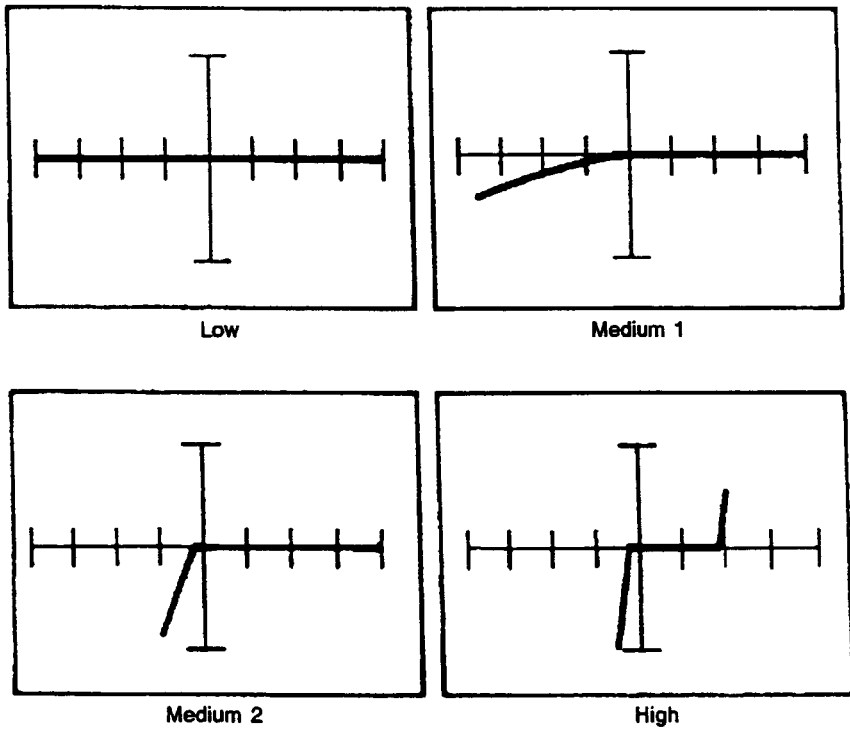

Figure 12-82. Signatures Between the +5V Pin and the -5V Pin of an 8080A at 60 Hz.



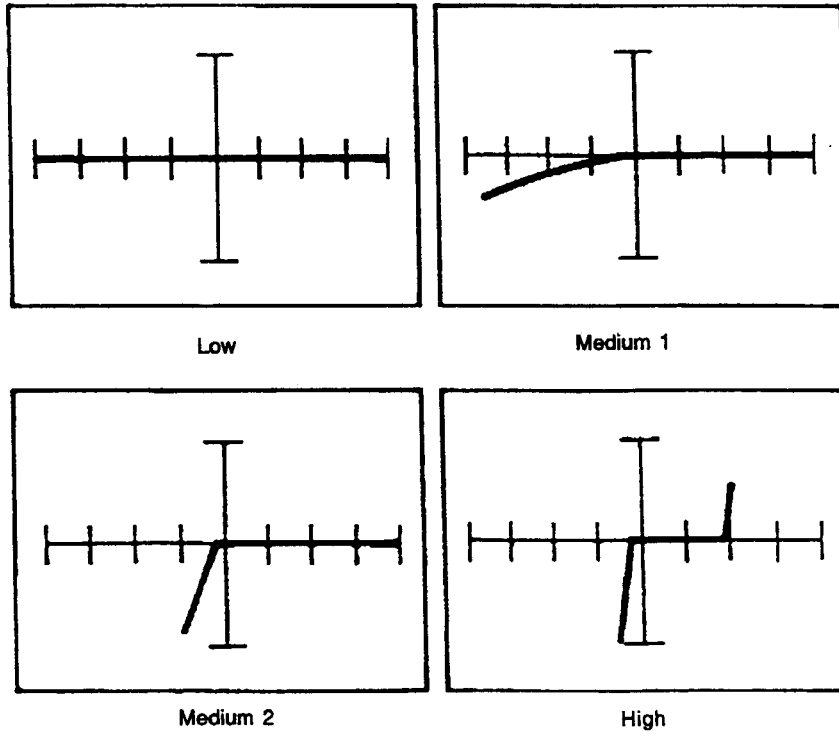

Figure 12-83. Signatures Between the +12V Pin and the -5V Pin of an 8080A at 60 Hz.

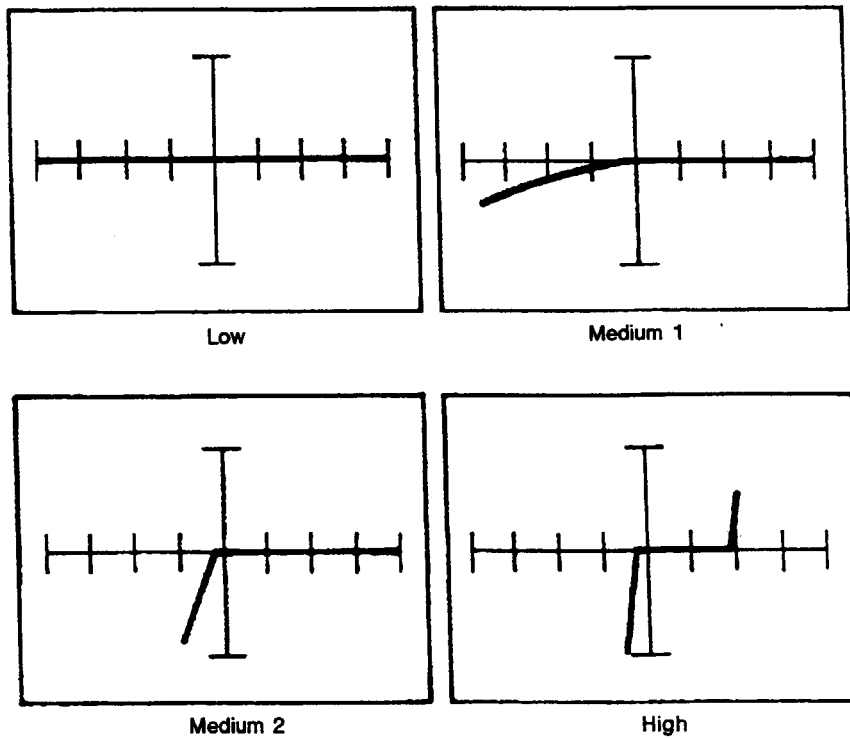

Figure 12-84. Signatures Between the INTE Pin and the -5V Pin of an 8080A at 60 Hz.

**TESTING INTEGRATED CIRCUITS**

**NOTES:**

# SECTION 13

## TESTING COMPONENTS BY COMPARISON

### 13-1. INTRODUCTION

The previous sections of this manual have described the techniques of using the 2000 to examine good components. This section describes the examination of defective components using the 2000 in alternate (comparison) mode.

As described in Section 2, when the Alternate button is selected, the 2000 operates in the alternate mode and will switch from displaying channel A to displaying channel B at a frequency set by the Rate control. In this mode, the common on a known good circuit or device is connected to the same common on the circuit or device under test. A dissimilarity in the signatures then shows an impedance difference between the known good device and the device under test. Refer to Figure 13-1 for 2000 connections in the alternate mode.

### 13-2. SETUP PROCEDURES

Set up the 2000, the known good device, and the device under test as follows:

1. Connect the channel A test lead to a known good device.
2. Connect the channel B test lead to the same node of the device under test.
3. Connect the 2000 common to the same nodes of the known good device and the device under test.
4. Select the alternate button. The 2000 circuit will alternately display the signature of the known good device and the device under test. By examining the signature differences, a defective component can be detected.

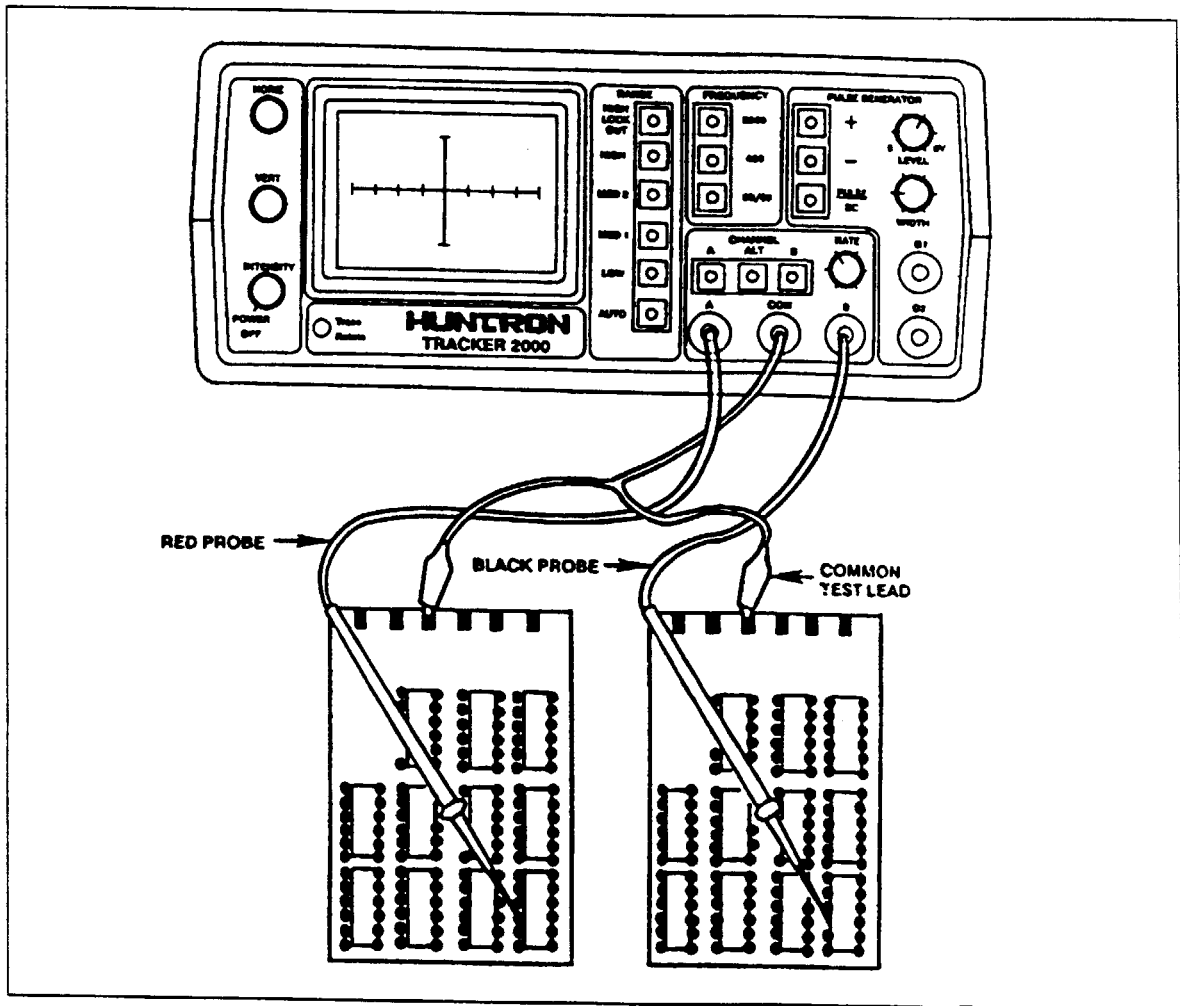

Figure 13-1. Alternate Mode Setup.

### 13-3. POWER TRANSISTOR MJE240

#### 13-4. MJE240 B-E Junction

Figure 13-2 shows the signatures of a known good MJE240 using the emitter as the common. This device has a sharp zener voltage ( $V_z$ ) across the B-E junction.

Figure 13-3 shows the signatures of a defective MJE240. This device has no zener voltages across the B-E junction in the medium 2 and high ranges.

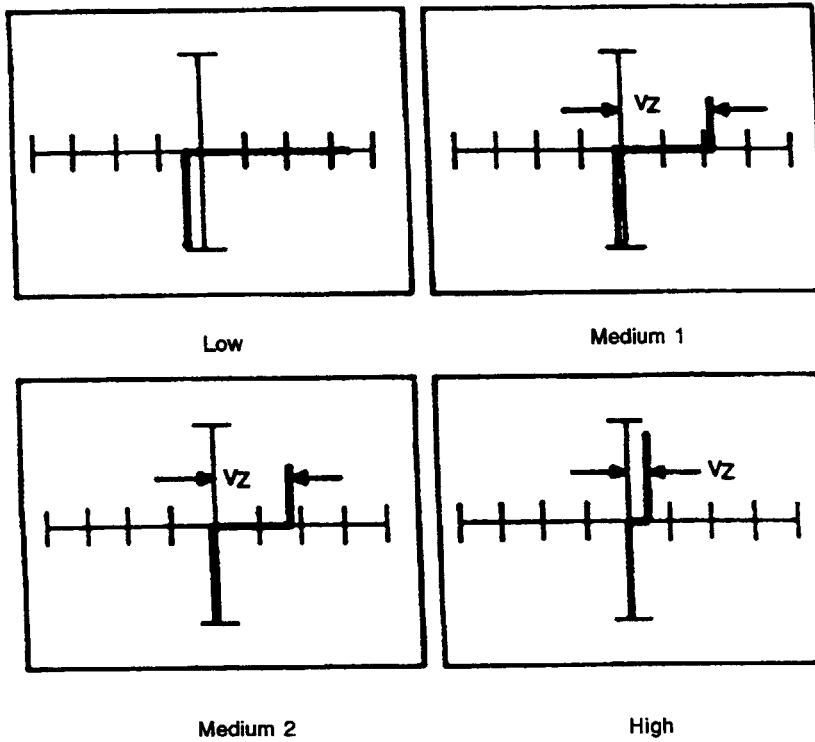

Figure 13-2. Signatures Between Base-Emitter of a Good MJE240 Transistor.

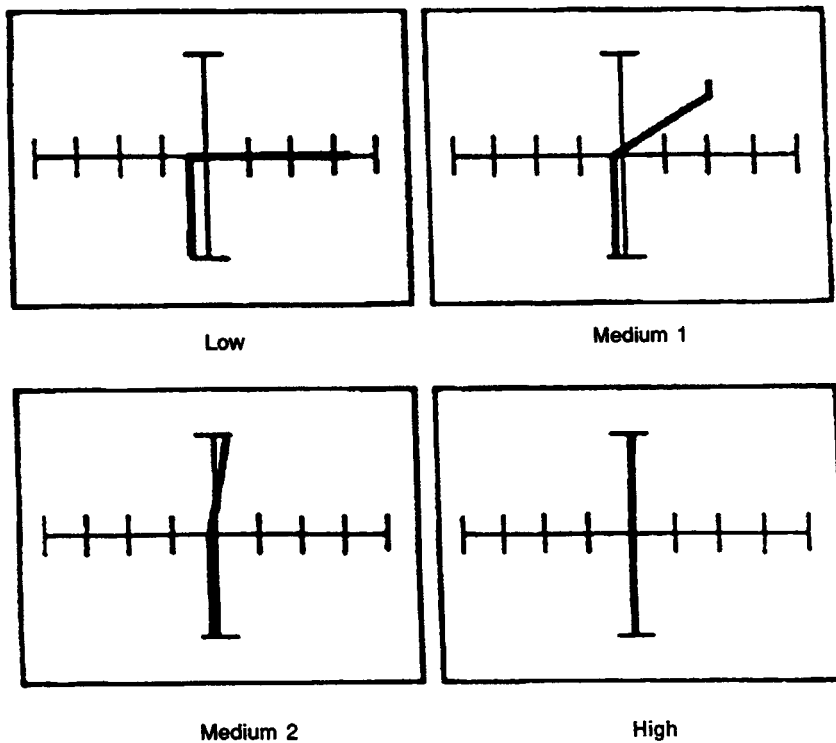

Figure 13-3. Signatures Between Base-Emitter of a Defective MJE240 Transistor.

### 13-5. MJE240 C-E Connection

Figure 13-4 shows the signatures of a known good MJE240 using the emitter as common. The MJE240 has a 80 Volt C-E breakdown voltage so the right side of the signature (positive half-cycle of the test signal) appears as an open circuit in all ranges. The current leg on the left side of the signature is due to a series connection of C-B junction (forward biased) and the B-E junction (zener breakdown). Since this is an NPN transistor, only the left side (positive C-E voltages) is normally used in most circuits, and the reverse breakdown does not affect anything.

Figure 13-5 shows the signatures of a defective MJE240.

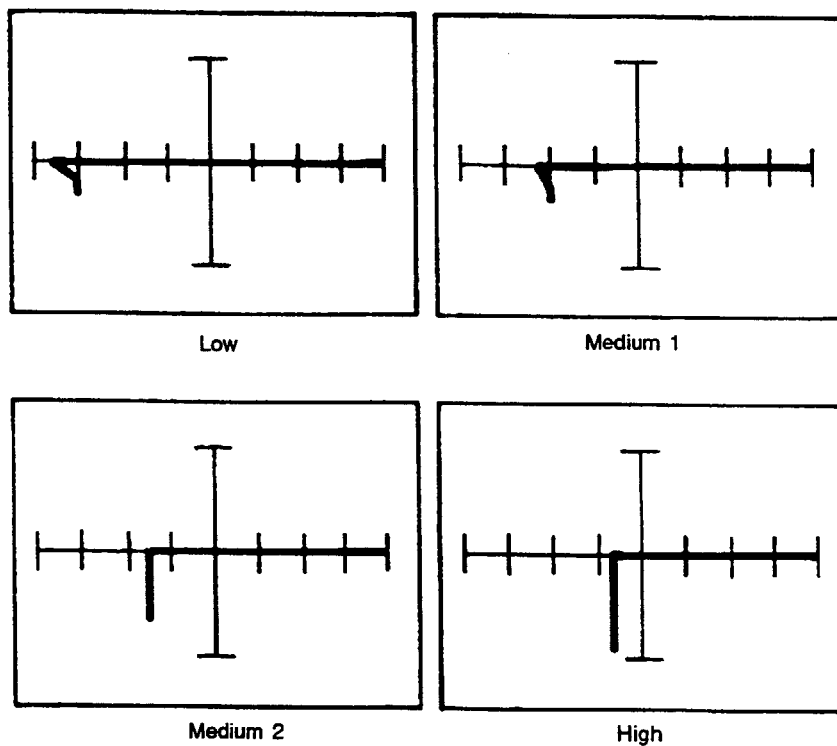

Figure 13-4. Signatures Between Collector-Emitter of a Good MJE240 Transistor.

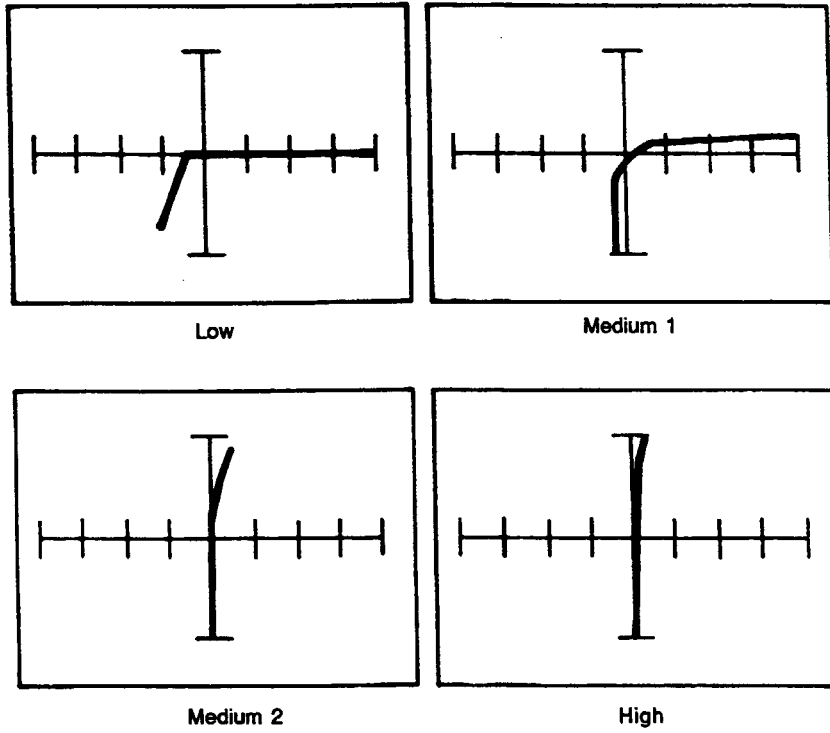

Figure 13-5. Signatures Between Collector-Emitter of a Defective MJE240 Transistor.

### 13-6. HIGH VOLTAGE DIODE HV15F

In this example, there is no signature difference when comparing a known good diode and defective diode in the low range. In the medium 2 and high ranges, the difference is obvious (see Figures 13-6 and 13-7).

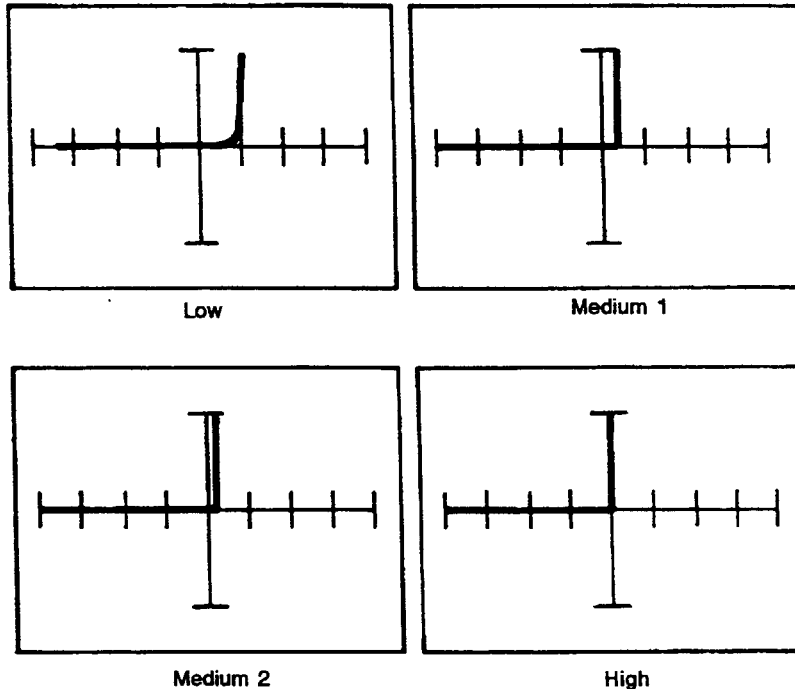

Figure 13-6. Signatures of a Good HV15F Diode.

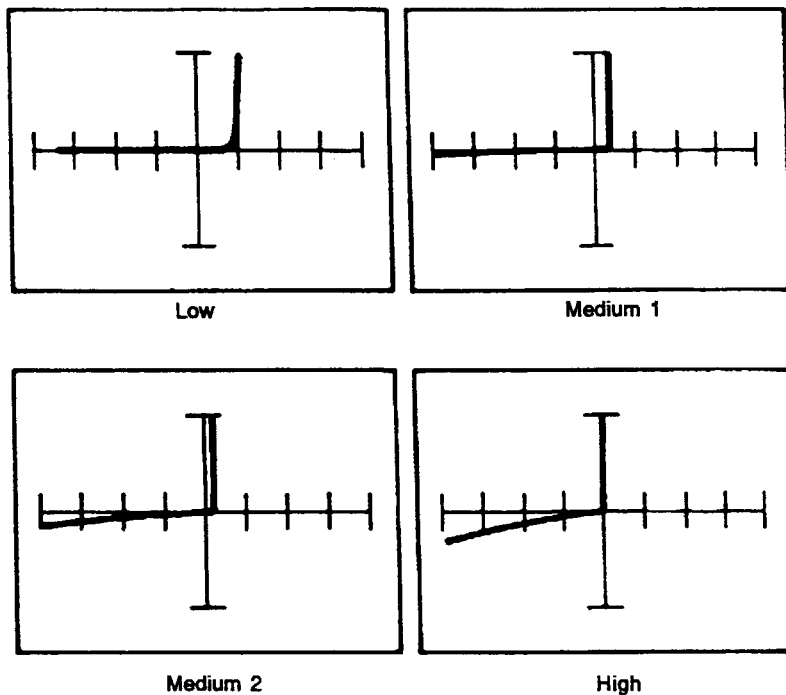

Figure 13-7. Signatures of a Defective HV15F Diode.



**13-7. 100 $\mu$ F 25V ELECTROLYTIC CAPACITOR**

For a good 100 $\mu$ F capacitor, a smooth ellipse is produced in the low range, while a defective capacitor displays an irregular shape. Figures 13-8 and 13-9 provide a comparison of good to defective capacitors.

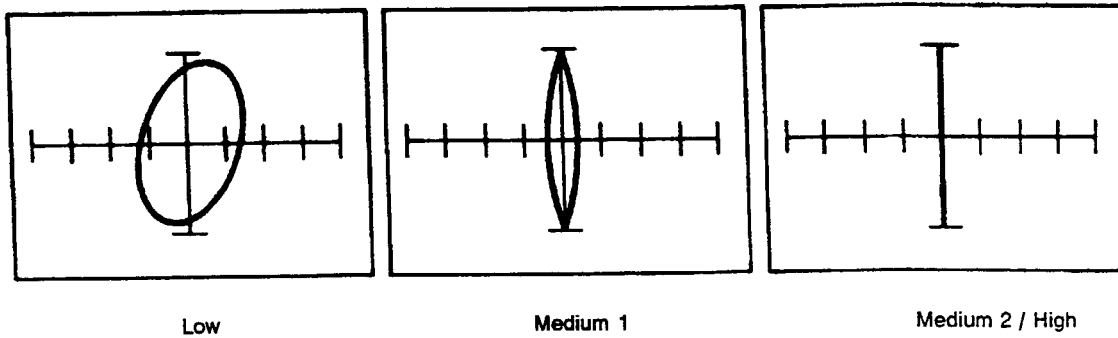

Figure 13-8. Signatures of a Known Good Capacitor.

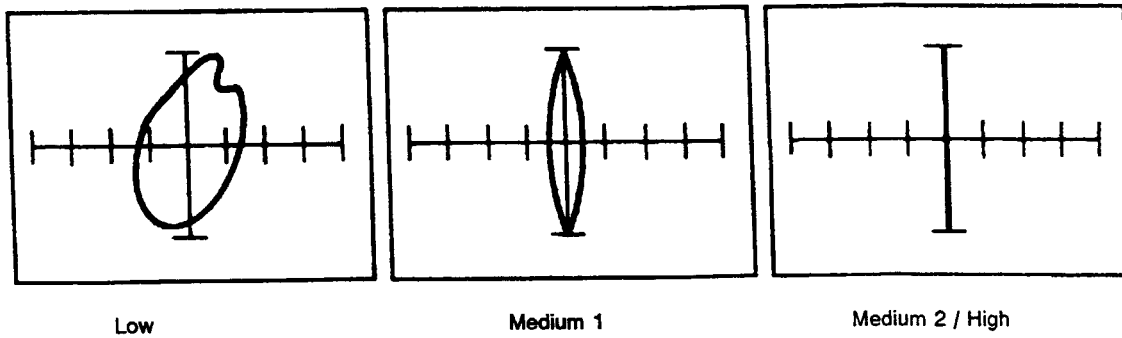

Figure 13-9. Signatures of a Defective Capacitor.

**TESTING COMPONENTS BY COMPARISON**

**NOTES:**

# SECTION 14

## SOLVING BUS PROBLEMS

### 14-1. INTRODUCTION

There are many different bus structures and it is not practical to analyze each one of them. The following paragraphs contain general troubleshooting information for several types of bus-related problems.

### 14-2. STUCK WIRED-OR BUS

Occasionally an integrated circuit will develop an internal short on a lead that is connected to a common bus. This causes a portion of the bus to remain fixed at some voltage level. If you check the stuck bus line to ground or the positive voltage supply with the 2000 in the low range, the signature will usually be a diagonal line indicating a short of 4 to 10  $\Omega$  (although some IC shorts are as high as 50 $\Omega$ ). A zero  $\Omega$  short (vertical line) would indicate a mechanical short (non-IC).

The shorted device is almost certain to have other pins that show serious flaws when connected to the 2000. To locate the defective device, switch the 2000 to the medium 2 range and check all the non-bussed pins of all devices connected to the bus. Be sure the common lead is connected to ground or the positive voltage supply. The defective device will show up as having flaws on more than one pin; usually on several pins.

### 14-3. UNSTUCK WIRED-OR BUS

In this type of bus problem, the signature presented on the 2000 does not indicate a short, but may show serious leakage current or some other flaw in the medium 2 range. This type of problem is solved in a similar manner to the previously described stuck bus. Connect the common lead to ground or the positive voltage supply and examine all the pins of all integrated circuits connected to the defective bus. Usually, the defective device will have more than one pin showing an internal defect. If there are not any chips with multiple pin failures, try heating or cooling each IC individually (using a soldering iron or circuit cooler, respectively) while watching the signature of the bus line that shows leakage. Since leakage is highly temperature dependent, the defective IC should cause the signature to change, whereas the good ICs should cause no substantial change. If the defect cannot be traced to a single device by this method, it is necessary to unsolder pins connected to the bus in order to pinpoint the defective device.

### 14-4. MEMORIES

Memory boards can be very difficult to troubleshoot if the system does not have built-in diagnostics to identify the section of memory where information cannot be stored or retrieved. The problem may be easily displayed on the 2000 on a bus line, but since memory devices have most of their pins connected in parallel, it is difficult to isolate the bus problem down to one device.

If the memory devices are in sockets, it is a simple matter to locate the problem using the 2000. Merely locate the bus line that provides a defective signature, then remove the memory devices one at a time until the signature indicates a normal bus line.

## SOLVING BUS PROBLEMS

If the memory devices are soldered in, fault isolation becomes more difficult. It should be noted that most memory failures are not due to failure of memory devices themselves, but more often to failures in the devices that access and control the memory section of the equipment. With this in mind, examine the memory control section of the equipment before spending much time on the actual memory devices.

If the failure is definitely in a memory device that is soldered to the PCB, find a pin that is not connected in common with the other memory devices like a chip select line (CS or CE on many memories). There must be at least one such pin per memory IC and the use of a schematic diagram is a definite help in making repairs of this type. Then check this non-bussed pin using the 2000 in the alternate mode, with the common lead of the 2000 tied to the defective bus line. Connect the channel A test lead to one non-bussed pin of one memory IC, and the channel B test lead to the same non-bussed pin of an adjacent memory IC. Compare the two signatures that result, looking for substantial changes in the shape of the signature between the two devices indicating that one of the two is probably the defective device. These changes in shape may or may not be accompanied by a DC shift (the signature shifts to the left or right as the 2000 alternates between channels). If there is only a DC shift and no change in the basic shape of the signature, that is probably due to manufacturing differences between the devices and should be ignored for the purpose of this comparison. If there are no substantial changes in the signatures of the first two devices, they are presumed to be functional and one should proceed to the next pair in the array of memory devices until the defective device is isolated. For example, if the PCB to be tested has sixteen memory ICs arranged in a two by eight array, start with the two ICs on one end and step through the array two by two for a total of eight times. If only one device is defective, one of those eight comparisons will show differences between the two devices. At that point, one should have a good idea of the "normal" signature that most of the devices have exhibited. The defective device is probably the one in the identified pair that is unlike this normal signature. This technique may not always work: sometimes a defective bus line may cause all the devices to show bad signatures and the defective IC cannot be isolated. If this occurs and there are multiple bus line failures, try using a different defective bus line as common and test all the devices again.

If none of the above troubleshooting methods provides a solution to the bus problem, unsolder one pin at a time from the defective bus line until its signature returns to normal.

# SECTION 15

## TROUBLESHOOTING TIPS

### 15-1. TIPS ON USING YOUR 2000

This section describes several tips that may be useful when using the 2000 to test various types of devices and circuits. This information is provided as a supplement to all testing information provided thus far in this manual. It is recommended reading whether or not it appears to apply to an immediate troubleshooting situation or not. There is no logical order to the presentation of the troubleshooting tips presented below.

Nearly all testing is performed with the medium 2, medium 1 or low range selected on the 2000. The high range should only be used if testing at a high impedance point, or if higher test voltage is required, such as when it is desired to examine the zener region of a 40 Volt device. Sometimes component defects are more obvious in one range than another, so if a suspect device appears normal for one range, try the other ranges.

When testing a single bipolar junction, such as a diode, a base-emitter junction, or a base-collector junction, the low range usually offers the best signature. However, if the device is being checked for reverse bias leakage, then a higher range should be used.

Attempt to relate the failure mode of the circuit under test to the type of defect indicated by the 2000. For example, a catastrophic printed circuit board failure can be expected to be caused by a failed device with a dramatic signature difference from that of a normal device of the same type. A marginally operating or intermittent board may have a failed component that indicates only a small pattern difference from normal.

Devices made by different manufacturers, especially digital integrated circuits, are likely to produce slightly different signatures. This is normal and does not necessarily indicate a failed device.

When performing in-circuit testing, always do a direct comparison to a known-good circuit of similar design, until a good skill level is acquired using the 2000.

If a failure symptom cannot be related to a specific area of the printed circuit board, begin by examining the signatures produced at the connector pins. This method of troubleshooting shows all the inputs and outputs and will often lead directly to the failed area of the board.

It should be kept in mind that leakage current doubles with every 10° Celsius rise in temperature. Leakage current shows up on the 2000 as a rounded transition (where the signature shows the change from zero current flow to current flow) or by causing curvature at other points in the signature. Leakage current causes curvature due to its nonlinearity.

Never begin the testing of an integrated circuit using the low range. If the low range is initially used, confusion can result from the inability of this range to display the various junctions. Always begin testing using the medium 1 range and, if the signature is a vertical line, switch to the low range to check for a short or low impedance (less than 500  $\Omega$ ). Switch to the low range if the device is suspect and appears normal in the medium 1 range. (This will reveal a defective input protection diode not evident using the medium 1 range.)

## TROUBLESHOOTING TIPS

It should be noted that the 2000 test leads are non-insulated only at the tips. Be sure that good contact is made to the device(s) under test.

Bipolar integrated circuits containing internal shorts produce a resistive signature (a straight line) beginning in the one o'clock to two o'clock position and ending in the seven o'clock to eight o'clock position on the 2000 display when using the low range. This type of signature is always characteristic of a shorted integrated circuit, and results from a resistive value of 4 to 10 $\Omega$ . A shorted diode, capacitor, transistor junction, etc. always produces a vertical (twelve o'clock) straight line on the 2000 display when using the low range.

When testing analog devices or circuits, the low range is used in most instances. Analog circuits contain many more single junctions, and any defects in these junctions show more easily when using the low range. Also, the 54 $\Omega$  internal impedance offered by the 2000 in the low range makes it less likely that other components in parallel with the device under test will load the 2000 sufficiently to alter the signature.

When testing an op amp in-circuit, it is highly recommended that it be compared directly with a known good circuit. This is because the many different feedback paths associated with op amps can cause an almost infinite number of signatures.

Often when checking a zener diode in-circuit, it will not be possible to examine the zener region due to circuit leakage from parallel components. If it is necessary to observe the zener region under this condition, one side of the diode must be unsoldered to eliminate the loading effects of the circuit.

# APPENDICES

## *NOTICE*

The following appendices are the results of tests performed on the Tracker HTR 1005B. The low, medium 2, and high ranges of the 2000 have the same power ratings as the low, medium, and high ranges respectively of the Tracker HTR 1005B. The medium 1 range of the 2000 has a power rating between the low range and the medium range of the Tracker HTR 1005B.

**This page intentionally left blank.**



# APPENDIX A

## HUNTRON TRACKER CMOS TEST

MTL Microtesting Limited  
Alton, Hampshire, England

### REQUIREMENT

It was required to ascertain whether normal usage of various types of Huntron Tracker instruments on any, or all, of their ranges could cause damage or catastrophic failure of normal CMOS devices.

### Equipment used

Five Huntron Trackers were used to conduct five tests simultaneously. All had been checked as conforming to manufacturers' standards prior to the test. Types were as follows:

Qty 1 Huntron Tracker Type HTR 1005BE  
Qty 3 Huntron Tracker Type HTR 1005B-1  
Qty 1 Huntron Tracker Type HTR 1005B-1S

The Compar-a-trace model was used in the Tracker mode (mode switch in "up" position) except during the actual Compar-a-trace test.

60 CMOS devices were obtained from three manufacturers as shown below. All were brand new devices and were delivered in protective packing. Half of the devices were retained as reference devices and were kept in protective conductive foam except when removed for data-logging at the beginning and end of the test. Each device was numbered and retained the same number throughout the test.

Device No.	Manufacturer	Type No.	Type	Used for
1	Motorola	MC14071BC	Quadruple 2-input OR Gate	Test
2	Motorola	MC14071BC	Quadruple 2-input OR Gate	Test
3	Motorola	MC14071BC	Quadruple 2-input OR Gate	Test
4	Motorola	MC14071BC	Quadruple 2-input OR Gate	Test
5	Motorola	MC14071BC	Quadruple 2-input OR Gate	Test
6	Motorola	MC14071BC	Quadruple 2-input OR Gate	Reference
7	Motorola	MC14071BC	Quadruple 2-input OR Gate	Reference
8	Motorola	MC14071BC	Quadruple 2-input OR Gate	Reference
9	Motorola	MC14071BC	Quadruple 2-input OR Gate	Reference
10	Motorola	MC14071BC	Quadruple 2-input OR Gate	Reference
11	Motorola	MC14081BC	Quadruple 2-input AND Gate	Test
12	Motorola	MC14081BC	Quadruple 2-input AND Gate	Test
13	Motorola	MC14081BC	Quadruple 2-input AND Gate	Test
14	Motorola	MC14081BC	Quadruple 2-input AND Gate	Test
15	Motorola	MC14081BC	Quadruple 2-input AND Gate	Test

Device No.	Manufacturer	Type No.	Type	Used for
16	Motorola	MC14081BC	Quadruple 2-input AND Gate	Reference
17	Motorola	MC14081BC	Quadruple 2-input AND Gate	Reference
18	Motorola	MC14081BC	Quadruple 2-input AND Gate	Reference
19	Motorola	MC14081BC	Quadruple 2-input AND Gate	Reference
20	Motorola	MC14081BC	Quadruple 2-input AND Gate	Reference
21	N.S.C.	MC14071BCN	Quadruple 2-input OR Gate	Test
22	N.S.C.	MC14071BCN	Quadruple 2-input OR Gate	Test
23	N.S.C.	MC14071BCN	Quadruple 2-input OR Gate	Test
24	N.S.C.	MC14071BCN	Quadruple 2-input OR Gate	Test
25	N.S.C.	MC14071BCN	Quadruple 2-input OR Gate	Test
26	N.S.C.	MC14071BCN	Quadruple 2-input OR Gate	Reference
27	N.S.C.	MC14071BCN	Quadruple 2-input OR Gate	Reference
28	N.S.C.	MC14071BCN	Quadruple 2-input OR Gate	Reference
29	N.S.C.	MC14071BCN	Quadruple 2-input OR Gate	Reference
30	N.S.C.	MC14071BCN	Quadruple 2-input OR Gate	Reference
31	N.S.C.	MC14081BCN	Quadruple 2-input AND Gate	Test
32	N.S.C.	MC14081BCN	Quadruple 2-input AND Gate	Test
33	N.S.C.	MC14081BCN	Quadruple 2-input AND Gate	Test
34	N.S.C.	MC14081BCN	Quadruple 2-input AND Gate	Test
35	N.S.C.	MC14081BCN	Quadruple 2-input AND Gate	Test
36	N.S.C.	MC14081BCN	Quadruple 2-input AND Gate	Reference
37	N.S.C.	MC14081BCN	Quadruple 2-input AND Gate	Reference
38	N.S.C.	MC14081BCN	Quadruple 2-input AND Gate	Reference
39	N.S.C.	MC14081BCN	Quadruple 2-input AND Gate	Reference
40	N.S.C.	MC14081BCN	Quadruple 2-input AND Gate	Reference
41	R.C.A.	MC14071BE	Quadruple 2-input OR Gate	Test
42	R.C.A.	MC14071BE	Quadruple 2-input OR Gate	Test
43	R.C.A.	MC14071BE	Quadruple 2-input OR Gate	Test
44	R.C.A.	MC14071BE	Quadruple 2-input OR Gate	Test
45	R.C.A.	MC14071BE	Quadruple 2-input OR Gate	Test
46	R.C.A.	MC14071BE	Quadruple 2-input OR Gate	Reference
47	R.C.A.	MC14071BE	Quadruple 2-input OR Gate	Reference
48	R.C.A.	MC14071BE	Quadruple 2-input OR Gate	Reference
49	R.C.A.	MC14071BE	Quadruple 2-input OR Gate	Reference
50	R.C.A.	MC14071BE	Quadruple 2-input OR Gate	Reference
51	R.C.A.	MC14081BE	Quadruple 2-input AND Gate	Test
52	R.C.A.	MC14081BE	Quadruple 2-input AND Gate	Test
53	R.C.A.	MC14081BE	Quadruple 2-input AND Gate	Test
54	R.C.A.	MC14081BE	Quadruple 2-input AND Gate	Test
55	R.C.A.	MC14081BE	Quadruple 2-input AND Gate	Test

Device No.	Manufacturer	Type No.	Type	Used for
56	R.C.A.	MC14081BE	Quadruple 2-input AND Gate	Test
57	R.C.A.	MC14081BE	Quadruple 2-input AND Gate	Test
58	R.C.A.	MC14081BE	Quadruple 2-input AND Gate	Test
59	R.C.A.	MC14081BE	Quadruple 2-input AND Gate	Test
60	R.C.A.	MC14081BE	Quadruple 2-input AND Gate	Test

A test jig was constructed using Vero-Board and high quality gold flashed 14-pin DIL sockets. Each socket was isolated from all others by track cutting in order to avoid any effects of circulating earth currents due to variations in the output levels of the various Huntron Test units. As each device contained four identical gates only one gate per device (pins 1, 2, and 3) was checked on each device, although data logging checked all gates.

## PROTECTION

All devices were kept in conductive foam except when actually being tested. Devices were only handled when a wrist earth strap (connected to the Test House Silent Earth) was being worn. The bench on which the tests were carried out was surfaced with a conductive mat also connected to the Silent Earth.

## TEST SYSTEM

The five Huntron Trackers were connected to the five test sockets with the Huntron black socket connected to pin 7 which was made a common earthpoint for all untested gates, and an earthpoint for the unconnected inputs in the tested gate. The Huntron's were left connected for a period of one hour, and then switched off and the devices changed. The first check was carried out on the Huntron low range with connections to pin 1 and pin 7 with pin 2 earthed. Pin 3 was left open circuit. After all test devices had been checked on pin 1, the Huntrons were then connected to pin 2 and pin 7 with pin 1 earthed and pin 3 open circuit. The final check per device was with the Huntrons connected to pin 3 with pins 1 and 2 earthed.

All devices (both reference and test) were data-logged on Imperial Technology IT200 equipment prior to the start of the tests. The test devices were then data-logged again after pin 1 tests were completed and again after the pin 2 tests. The final data-logging was completed when all tests on pins 1, 2, and 3 were complete with the Huntrons switched to the low range

All test devices were then tested in a similar way using the Huntrons on medium range, except that the test devices were not data-logged after pins 1 and 2 were completed. Data-logging did take place when tests on pin 3 were complete. Devices were then tested using the high range with data-logging again taking place on completion of tests on pin 3. In order to check the effect (if any) on the Huntron Compar-a-trace action on the CMOS devices a sample device of each manufacturer was subject to ten minutes Compar-a-trace action on the low range (2.53V) output at approx .9Hz cycle rate (Nos. 2, 22, 42; and 12, 32, 52). The six devices (3 x 4071 and 3 x 4081) were then data-logged.

In order to ascertain whether leads connecting the Huntrons to the devices under test could act as antennae in the region of weak fields of electro-magnetic radiation, thus causing damage to the devices, the five Huntrons were left connected to five test devices (2 x Motorola-No 1, a 4071 and No 11, a 4081; 2 x NSC-No 21, a 4071, and No 31, a 4081; and 1 x RCA-No 41, a 4071).

The devices under test were then subjected to radiation from a battery driven, all solid-state frequency modulation type transmitter operating on 145MHz. The PA input power was approximately 2 watts and the antenna was a 1/4 whip vertical located approximately 19" (1/4) from the center of the interconnecting wiring. Modulation was NOT applied but the carrier was switched at irregular intervals. Induction was evident by "jumping" of the Huntron traces, except on the type HTR 1005BE. RF was radiated for approximately 15 minutes. The devices were then data-logged. All sixty off devices were then loaded onto static burn-in boards with input and output pins terminated to Vcc by 47K pull-up resistors and then loaded into a Ceetel burn-in chamber at 125 degrees Celsius. After 48 hours at 125 degrees Celsius the devices were removed from the oven and all devices data-logged. The devices were then re-loaded into the burn-in chamber for a further 120 hours burn-in at 125 degrees Celsius. The devices were then finally data-logged to determine the long-term effect (if any) of the Huntron Trackers.

## ROTATIONAL TESTING

In order to ensure that any variations in output levels of the three types of Huntron Instruments used did not affect part of the test series devices only, devices under test were "rotated" around the test instruments as shown in the table below. The figures shown represent the Test Number followed by the Section Number, i.e. 9/2 = Test No. 9, the 2nd Part.

### HUNTRON INSTRUMENTS

Device No.	1	2	3	4	5
1	1/1	3/1	5/1	9/1	7/1
2	7/2	1/2	3/2	5/2	9/2
3	9/2	7/2	1/3	3/2	5/2
4	5/3	9/3	7/3	1/3	3/3
5	3/3	5/3	9/3	7/3	1/3
11	2/1	4/1	6/1	10/1	8/1
12	8/2	2/2	4/2	6/2	10/2
13	10/2	8/1	2/2	4/2	6/2
14	6/3	10/3	8/1	2/3	4/3
15	4/3	6/3	10/3	8/3	2/3
21	7/1	1/1	3/1	5/1	9/1
22	9/2	7/2	1/2	3/2	5/2
23	5/2	9/1	7/2	1/2	3/2
24	3/2	5/2	9/2	7/2	1/2
25	1/3	3/3	5/3	9/3	7/3
31	8/1	2/1	4/1	6/1	10/1
32	10/1	8/1	2/1	4/1	6/1
33	6/2	10/2	8/1	2/2	4/2
34	4/2	6/2	8/2	10/2	2/2
35	2/3	4/3	6/3	10/3	8/3

Device  
No.

## HUNTRON INSTRUMENTS

---

41	5/1	9/1	7/1	1/1	3/1
42	3/1	5/1	9/1	7/1	1/1
43	1/2	3/2	5/1	9/2	7/2
44	7/3	1/3	3/3	5/3	9/3
45	9/3	7/3	1/3	3/3	5/3
51	6/1	10/1	8/1	2/1	4/1
52	4/1	6/1	10/1	8/1	2/1
53	2/2	4/2	6/1	10/2	8/2
54	8/3	2/3	4/3	6/3	10/3
55	10/3	8/3	2/3	4/3	6/3

## RESULTS SUMMARY

1. Motorola devices appeared to be more sensitive on the input pins when subject to the Tracker tests.
2. No change in functionality of DC parameters were exhibited on any device subjected to stimulus from the Huntron on all ranges prior to burn-in at 125 degrees Celsius.
3. Device No. 1 (Motorola 14071) failed supply current after 48 hours burn-in. Device No. 3 (Motorola 14071) failed supply current and functionality in gate No. 4 (pins 11, 12 and 13) after 48 hours burn-in.
4. Device No. 1 failed supply current and functionality in gate No. 4 (pins 11, 12 and 13) after 168 hours burn-in. Device No. 17 (Motorola 14081 Reference device) failed supply current after 168 hours burn-in.

## CONCLUSIONS

Although three devices failed during static burn-in it is felt that the failures cannot be attributed to any harmful effects due to stimulus from the Huntron Trackers as the failure modes were totally independent of pins 1, 2 and 3 which were pin stimulated by the Trackers. Furthermore, one of the devices which failed during burn-in was a Reference device which was not connected to the Tracker in any form.

It should be noted that the burn-in condition which was applied to the devices was very extreme (viz., 125 degrees) for plastic encapsulated devices and that the incident of failure is unlikely to be related to the test performed by the Huntron Tracker.

**NOTES:**

# Appendix B

## HUNTRON TRACKER TTL AND CMOS TESTS

Component Concepts  
Everett, WA 98201

OBJECT: To determine the effect of the testing signals from a Huntron Tracker in-circuit component tester on performance of CMOS and TTL integrated circuits.

COMPONENT TESTED: Motorola MC 14011 and TI 74LS11

(1) Burn-in (100%) 180 pieces at 125 degrees Celsius = 48 hours

(2) Electrical (100%) to obtain 150 units to be labeled as follows:

Label 25 units as HH1, HH2, HH3.....	HH25
Label 25 units as HM1, HM2, HM3.....	HM25
Label 25 units as HL1, HL2, HL3.....	HL25
Label 25 units as VH1, VH2, VH3.....	VH25
Label 25 units as VM1, VM2, VM3.....	VM25
Label 25 units as VL1, VL2, VL3.....	VL25

(3) Electrical (100%) in the following sequence:

(a)	HH1, HH2.....	HH25
(b)	HM1, HM2.....	HM25
(c)	HL1, HL2.....	HL25
(d)	VH1, VH2.....	VH25
(e)	VM1, VM2.....	VM25
(f)	VL1, VL2.....	VL25

For DC Parametrics and function per the manufacturers specifications.  $T_A = 25$  degrees Celsius. They are to be tested on HP5054 digital IC tester. All parameters datalogged. Propagation delay tested per specification for pass/fail only.

(4) Connect Huntron Tracker to sequencer (sequencer is a piece of equipment supplied by Huntron Instruments, Inc. which applies testing signals from the Tracker and tester to device under test) to each piece of equipment and turn on power.

(5) (a) Set Tracker range to HIGH.

(b) Set Tester range to HIGH.

(c) Insert HH1 in zero-insertion force socket marked "Huntron Tracker" located on top of sequencer.

(d) Activate "start" button on sequencer. The red LED will come on when sequencing is completed (it takes about 90 seconds).

- (e) Remove devices under test.
- (f) Repeat steps (c), (d), (e), (f), for HH2, HH3, ..., HH25.
- (6) Set Tracker and tester range to medium and repeat steps (c), (d), (e), (f), for HM1, HM2, ..., HM25 and VM1, VM2, ..., VM25.
- (7) Set Tracker and tester range to low and repeat steps (c), (d), (e), (f), for HL1, HL2, ..., HL25 and VL1, VL2, ..., VL25.
- (8) Electrical test (100%) in the following sequences:

HH1, HH2.....HH25  
 HM1, HM2.....HM25  
 HL1, HL2.....HL25  
 VH1, VH2.....VH25  
 VM1, VM2.....VM25  
 VL1, VL2.....VL25

For DC parametrics and function per the manufacturer's specifications  $T_A = 25$  degrees Celsius. Propagation delay tested per specification for pass/fail only. All parameters datalogged on the HP5054 digital tester.

## TEST REPORT

Component Concepts, Inc., an independent test lab for active electronic components, performed testing on the effect of part exposure to the Huntron "Tracker". The Huntron "Tracker" is an in-circuit stand-alone component tester. Two types of parts were tested and pertinent data recorded prior to test with the "Tracker". The parts were then tested and data logged after the "Tracker" test. The two sets of data, pre- and post-, were then compared for any possible effect that the "Tracker" might have upon the parts. Seventy-five pieces of 74LS11's and seventy-five of 4011's were tested. All parts passed after testing with the Huntron. The datalogged parameters were input and operating current, and output voltage. No discernible effects were observed upon analysis of the pre- and post- data logs.

The exact test flow is as follows:

1. All parts before testing were subjected to 48 hours burn-in at 125 degrees Celsius.
2. 74LS11 and 4011 tested for pass/fail operation at 125 Celsius.
3. 75 of each part tested for propagation delay, pass/fail.
4. Parts datalogged for specific parameters.
5. Parts subjected to test by the Huntron instrument.
6. Propagation delay tested.
7. Post-test datalog performed, some parameters recorded.
8. Datalogs analyzed to determine any effects of the Huntron "Tracker" upon parts.



## TEST DISCUSSION

The testing procedures used can only validate the externally measurable parameters of the part and its function. The internal functioning of the part can be assumed to follow with the externally measurable parameters.

The lot of parts received from Huntron were uniform in date code and manufacture. All parts were 100% functional after a static burn-in of 48 hours. The TTI and CMOS parts were tested on a Hewlett Packard 5045 IC Tester (Ser.# 1712A00222). The data was recorded on a companion HP9825 Calculator. Huntron provided a "Tracker" and "Sequencing Unit". The Huntron "Tracker" (Ser.# 21F01001), was connected to the sequence unit which, according to Huntron, automatically connected the leads of the part to the tester one lead at a time. The actual functioning of the sequencer and the two test units are not the responsibility of Component Concepts other than the following of instructions provided by Huntron for proper operation. After burn-in the parts were tested pass/fail for propagation delay in a bench set-up using a pulse generator and a 100MHz HP oscilloscope. The parts were also datalogged. They were then tested on the sequencer with the two testers attached. After being tested with the sequencer the parts were again tested for propagation delay and datalogged. At all times attention was paid to static ESD precautions.

## TEST RESULTS

At pre-test, after burn-in, all parts were functional for DC and AC parameters, seventy-five parts were data-logged from each part type, 74LS11 and 4011BC. A comparison of data after testing showed no significant change in either input current or output voltage under load. The data printed out by the HP9825 Calculator was reduced to a more readable format which clearly shows the value recorded before and after the differences between the two values. The majority of differences between values are within the accuracy limits of the HP5045 Tester. Points where there are differences greater than that value are not significant in number to produce any possible negative conclusions on tester interaction with the tested parts. Based on the collected data, the Huntron "Tracker" had no discernable impact on the parts tested.